

OEM MODEL Section 9 Page #'s

AUTOPSY SAWS

STRYKER

810	300-301
811	300-301

CAST CUTTERS

AMERICAN ORTHOPAEDIC™

Cast Cutter	300-301
-------------------	---------

BURNETT INSTRUMENT, INC.

182106	300
--------------	-----

STRYKER

840	300-301
841	300-301
848	300-301
851	300-301
940	302-304
941	302-304

CAST SPREADERS

STRYKER

“Heavy Duty” 83	301
“Standard” 82	301

HYDROCOLLATORS

CHATTANOOGA

D3	200
E1	200-202
E2	200-202
M2	200-202
M4	200-202
SS	200-202
SS2	200-202

LOGAN

H-1 (HOT PAK)	203
---------------------	-----

VACUUMS

STRYKER

Plaster Vac 843 & 846	301
New Style “Plaster Vac” 855 & 856	301
New Style “Plaster Vac” 860 & 862	301

RPI Part #CHH015
OEM Part #22267



HEATING ELEMENT

- 1500W, 120VAC, ~10 Ω
- Includes all parts as shown
- Also available: Bracket (Element Support) (RPI Part #CHB017)

Fits: Tank
Model: M4

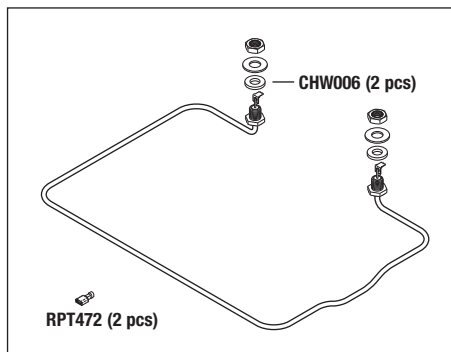

RPI Part #CHH001
OEM Part #10630

HEATING ELEMENT ASSEMBLY

- 1000W, 120VAC, ~14.5 Ω
- Includes all parts as shown

Fits: Tank
Models: E1, E2, M2, SS & SS2

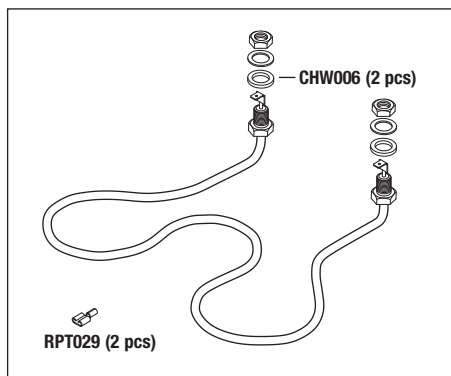

RPI Part #CHH002
OEM Part #21298

HEATING ELEMENT ASSEMBLY

- 500W, 120VAC, ~30 Ω
- Includes all parts as shown

Fits: Tank
Model: D3

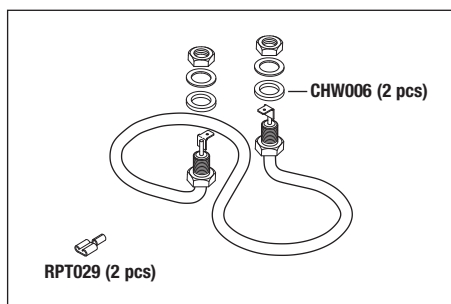

RPI Part #CHT014
OEM Part #20548



OVERHEAT THERMOSTAT

- Manually resettable, Opens at 190°F (88°C)
- 10A @ 120VAC; 5A @ 240VAC
- Capillary ~ 24" lg. with soldered fitting
- Includes all parts as shown
- Also available: Bracket (Bulb Support) (RPI Part #CHB018)

Fits: Tank
Model: M4

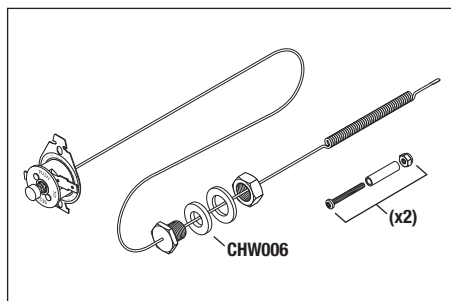

RPI Part #CHB018
OEM Part #21023



BRACKET (BULB SUPPORT)

- Material: Stainless steel
- Fits:** Attaches the Thermostat and Overheat Thermostat Capillary Bulbs to the Heating Element

Models: D3, E1, E2, M2, M4, SS & SS2

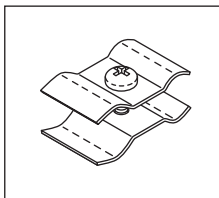

RPI Part #CHT003
OEM Part #10631

THERMOSTAT

- Off at 140°F - 170°F
- 20A @ 120/240VAC
- Includes all parts as shown
- Also available: Bracket (Bulb Support) (RPI Part #CHB018)

Fits: Mounts to Chassis and Tank
Models: D3, E1, E2, M2, M4, SS & SS2

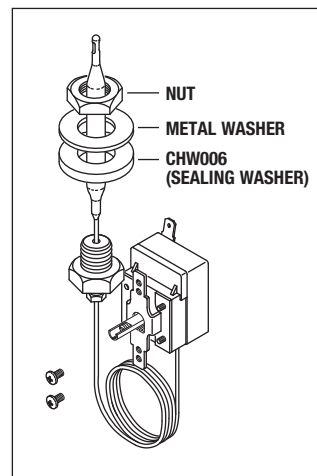

RPI Part #CHW006

OEM Part # (No OEM Part # Available)



SEALING WASHER

- 3 per package
- Size: .445" ID X .882" OD X .125" thk.
- Material: Red silicone

Fits: Thermostat and Heater Bushing

Models: D3, E1, E2, M2, M4, SS & SS2



RPI Part #CHB017
OEM Part #22356



BRACKET (ELEMENT SUPPORT)

- 2 per package
- Material: Stainless steel
- Includes all parts shown

Fits: Heating Element
Model: M4

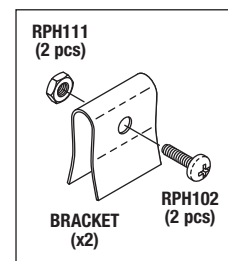

Orthopedics & Physical Therapy

Chattanooga

Models: D3, E1, E2, M2, M4, SS & SS2

RPI Part #CHS004
OEM Part #23406

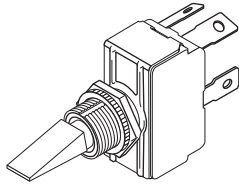

POWER SWITCH

- 20A @ 250VAC; DPST
- Switch (On-Off)
- .250" Tabs
- Includes: Mounting hardware

Fits: Chassis

Models: E1, E2, M2, M4, SS & SS2

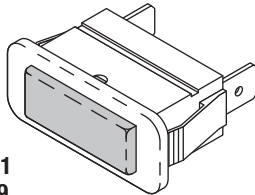

RPI Part #CHL011
OEM Part #22149

PILOT LIGHT (RED)

- 1/3W @ 125VAC
- .250" Tabs
- Red lens with white body

Fits: Chassis

Model: M4

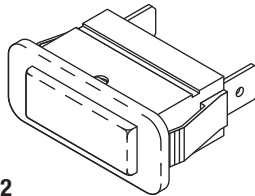

RPI Part #CHL012
OEM Part #22148 (New Style)

PILOT LIGHT (CLEAR)

- New Style: .250" Tabs and 1.181" x .433" cut out
- 1/3W @ 125VAC
- Clear lens with white body

Fits: Chassis

Models: E1, E2, M2 & M4

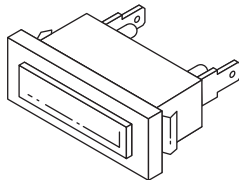

RPI Part #CHL005
OEM Part #22148 (Old Style)

STANDARD LIGHT

- Old Style: .188" Tabs and 1.281" x .395" cut out
- 1/3W @ 125VAC
- Clear lens with metal bezel

Fits: Chassis

Models: E1, E2, M2, M4, SS & SS2

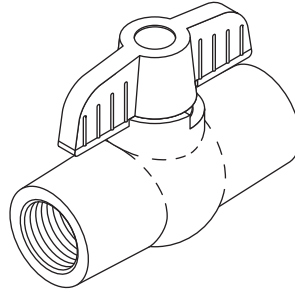

RPI Part #CHV009
OEM Part #21085

DRAIN VALVE (1/2")

- Material: PVC
- Size: 1/2" FPT Inlet and Outlet
- Also available: Coupler (RPI Part #RPC810)

Fits: Drain Pipe

Models: M2, M4 & SS2

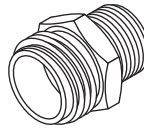

RPI Part #RPC810
OEM Part #23392

COUPLER

- Material: Brass
- Size: 1/2" MPT x 3/4" male garden hose thread
- Also available: Drain Valve (1/2") (RPI Part #CHV009)

Fits: Drain Valve

Models: M2, M4 & SS2

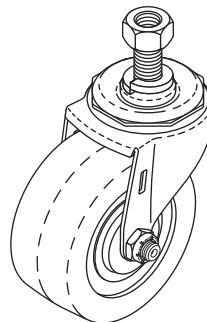

RPI Part #CHC010
OEM Part #21260

CASTER (3")

- 3" dia. x 1-1/4" wide tread
- Load Capacity: 125 lbs.
- Non-marking soft rubber tread
- 7/16-14 X 7/8" Lg. threaded stem mount
- Height: 3-5/8"; Without brake
- Zinc plated steel, ball bearing swivel
- Includes: Mounting hardware

Fits: Chassis Base

Model: M4

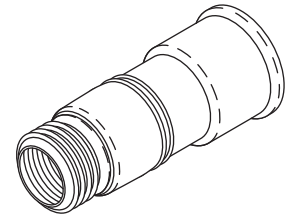

RPI Part #RPA724
OEM Part #21882

WATER THIEF

- Connects a garden hose to a threadless faucet
- Also available: Washer (Hose Bib) (RPI Part #RPH756) & Drain Hose (RPI Part #CHH016)

Fits: Drain Hose

Models: E2, M2, M4, SS & SS2

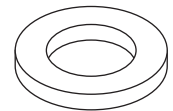

RPI Part #RPH756
OEM Part #

WASHER (HOSE BIB)

- 10 per package
- Material: Red rubber
- Fits any standard garden hose thread
- Also available: Drain Hose (RPI Part #CHH016) & Water Thief (RPI Part #RPA724)

Fits: Drain Hose

Models: E2, M2, M4, SS & SS2

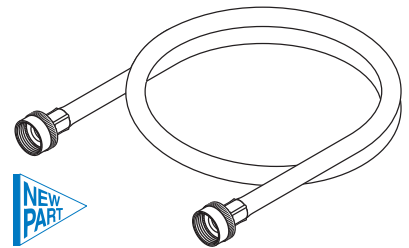

RPI Part #CHH016
OEM Part #21635

DRAIN HOSE

- Material: Black rubber
- Length: 4 ft
- Fitting Size: 3/4" female garden hose thread
- Includes: (2 pcs) Washer (Hose Bib) (RPI Part #RPH756)
- Also available: Water Thief (RPI Part #RPA724)

Fits: Coupler

Models: E2, M2, M4, SS & SS2

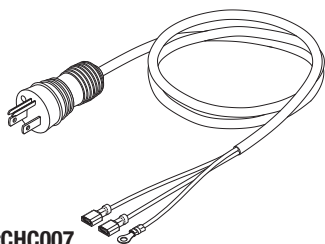

RPI Part #CHC007
OEM Part #20568

HOSPITAL GRADE POWER CORD

- Length: 8 ft.
- Splash resistant
- 14/3 SJTOW, 105°C; 15A @ 125VAC
- Plug: NEMA 5-15P; Connector: (1) #10 Ring Terminal & (2) 1/4" QC Terminals
- Color: Black; .328" OD
- Also available: Strain Relief (RPI Part #RPB164)

Fits: Chassis
Model: M4

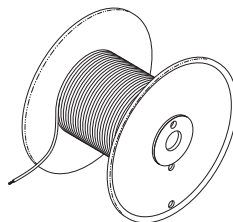

RPI Part #RPW803
OEM Part #21031 (Harness Complete), 61579
(Harness Complete) & 21617 (Harness Complete)

HOOK UP WIRE (BROWN)

- Sold by the foot (Reel NOT included); Color: Brown
- #14 AWG, 41/30 strand, UL3173
- Voltage Rating: 600V
- Insulation: Polyolefin
- Max. Operating Temperature: 257°F (125°C)

Models: E1, E2, M2, M4, SS & SS2

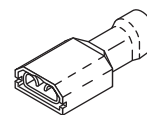

RPI Part #RPT472
OEM Part #21031 (Harness Complete), 61579
(Harness Complete) & 21617 (Harness Complete)

QC TERMINAL (1/4 FEMALE)

- 20 per package
- Fully Insulated; Color: Blue
- Size: For #14 - 16 AWG Wire

Models: E1, E2, M2, M4, SS & SS2

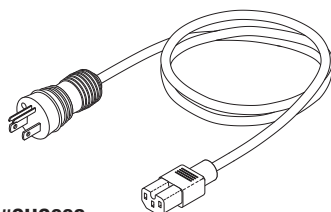

RPI Part #CHC008
OEM Part #20909

HOSPITAL GRADE POWER CORD

- Length: 8 ft.
- Splash resistant
- Black, 14/3 SJTOW, 105°C; 15A @ 125VAC
- Plug Type: NEMA 5-15P
- Connector Type: EN60320-C15 (Keyed mating feature)
- Also available: AC Inlet Receptacle (RPI Part #RPR710)

Fits: AC Inlet Receptacle
Model: M4

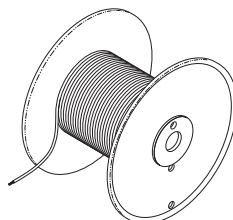

RPI Part #RPW804
OEM Part #21031 (Harness Complete), 61579
(Harness Complete) & 21617 (Harness Complete)

HOOK UP WIRE (BLUE)

- Sold by the foot (Reel NOT included); Color: Blue
- #14 AWG, 41/30 strand, UL3173
- Voltage Rating: 600V
- Insulation: Polyolefin
- Max. Operating Temperature: 257°F (125°C)

Models: E1, E2, M2, M4, SS & SS2

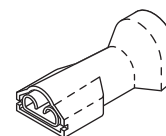

RPI Part #RPT802
OEM Part #21031 (Harness Complete), 61579
(Harness Complete) & 21617 (Harness Complete)

QC TERMINAL (1/4 FEMALE)

- 20 per package
- Fully Insulated; Color: Yellow
- For #10-12 AWG Wire

Models: E1, E2, M2, M4, SS & SS2

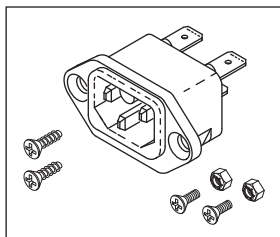

RPI Part #RPR710
OEM Part #20908

AC INLET RECEPTICLE

- 15A @ 125VAC
- .250" Tabs
- Keyed Mating feature
- Includes all parts as shown

Fits: Chassis
Model: M4

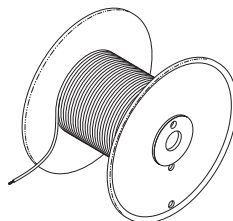

RPI Part #RPW382
OEM Part #21031 (Harness Complete), 61579
(Harness Complete) & 21617 (Harness Complete)

HOOK UP WIRE (BLACK)

- Sold by the foot (Reel NOT included); Color: Black
- #14 AWG, 41/30 strand, UL3173
- Voltage Rating: 600V
- Insulation: Polyolefin
- Max. Operating Temperature: 257°F (125°C)

Models: E1, E2, M2, M4, SS & SS2

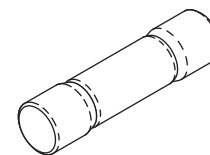

RPI Part #RPF764
OEM Part #20906

FUSE (15A) - FAST ACTING

- 1 per package
- 15A @ 600VAC
- Size: 13/32" dia. x 1-1/2" lg.

Fits: Fuse Holder
Model: M4

RPI Part #LOH001
OEM Part #H-1 (HOT PAK)

HEATING ELEMENT ASSEMBLY

- 1000W, 120VAC, ~14.5 Ω
- Includes (2) .125" fiber washer, (2) 1/2-20 mounting nut, (6) #6 flat washer, and (4) #6-32 terminal nut
- Mounts in bottom of tank

Model: H-1 (Hot Pak)

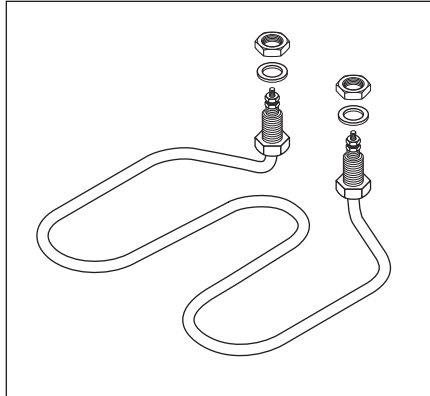

Quantity price breaks are available on all parts.

NOTES: _____

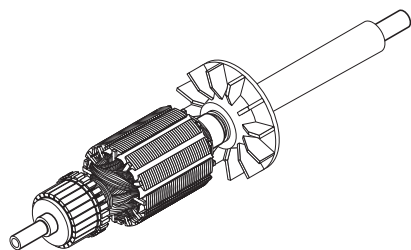

RPI Part #STA026
OEM Part #870-1-8
ARMATURE ASSEMBLY (115VAC)
 • 115 VAC
Models: Autopsy Saw: 810;
 Cast Cutter: 840 & 848

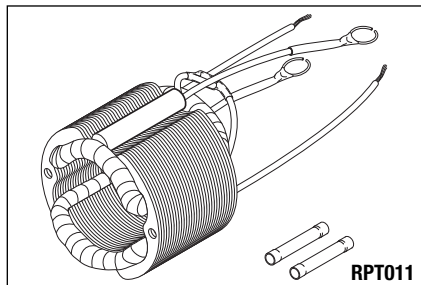

RPI Part #STF027
OEM Part #840-3-32
FIELD ASSEMBLY (115VAC)
 • 115 VAC
 • Thermal Protector built-in
 • Coil resistance ~5Ω
 • Includes (2) Butt Connector (RPI Part #RPT011)
Models: Autopsy Saw: 810;
 Cast Cutter: 840 & 848

Also fits Stryker 900 Series!

RPI Part #STB002
OEM Part #870-1-13

BRUSH
 • 2 per package
 • Size: 3/16" x 3/16" x 1/2" lg
 • Spring length: 1.000"
Fits: Brush Holder Assembly
Models: American Orthopedic Cast Cutter;
 Autopsy Saw: 810 & 811; Cast Cutter:
 840, 841, 848 & 851



RPI Part #RPC039
OEM Part # (No OEM Part # Available)

BRUSH CAP
 • 6 per package
 • 5/8-27 thread
 • Also available, Brush (RPI Part #STB002)
Models: Autopsy Saw: 810 & 811;
 Cast Cutter: 840, 841, 848 & 851



REDESIGNED! Now can be used with Stryker 800 & 900 Series!



RPI Part #STL016
OEM Part #840-1-5 (800 Series only)
SHAFT LINK
 • Hardened steel
 • Presses onto shaft
Models: American Orthopedic Cast Cutter;
 Autopsy Saw: 810 & 811;
 Cast Cutter: 840, 841, 848 & 851

This part replaces RPI Part #STB001



RPI Part #STB015
OEM Part #840-25-11
CAST CUTTER BLADE (2-1/2")
 • Use for cutting fiberglass and plaster casts
Models: Cast Cutter: 840, 841, 848 & 851
 Also fits Burnett models

REDESIGNED! Now can be used with Stryker 800 & 900 Series!

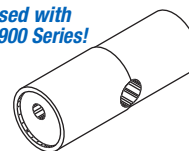

RPI Part #STT010
OEM Part # (No OEM Part # Available)
CAM TOOL
 • Use to install and remove Cam (RPI Part #STC009 & STC029)
 • ~3/4" dia. x 1-1/2" lg; Material: S.S.
 • 5/16" dia. thru hole for crossbar leverage
Models: American Orthopedic Cast Cutter;
 Autopsy Saw: 810 & 811;
 Cast Cutter: 840, 841, 848 & 851

RPI Part #STS023
OEM Part #870-1-3
SHAFT
 • Hardened steel
 • Mounts through housing
Models: Cast Cutter: 840, 841, 848 & 851

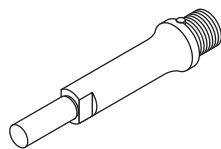

RPI Part #STC011
OEM Part #840-1-13
COLLAR
 • Mounts on top of blade
Models: Autopsy Saw: 810 & 811;
 Cast Cutter: 840, 841, 848 & 851



RPI Part #STC009
OEM Part #840-2-7
CAM
 • Mounts on tip of armature shaft
 • For easy installation/removal, use Cam Tool (RPI Part #STT010)
Models: American Orthopedic Cast Cutter;
 Autopsy Saw: 810 & 811;
 Cast Cutter: 840, 841, 848 & 851

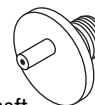

RPI Part #STW025
OEM Part #13-4
INTERNAL TOOTH WASHER
 • 3/8 thread
Fits: Shaft
Models: Autopsy Saw: 810 & 811;
 Cast Cutter: 840, 841, 848 & 851



RPI Part #STS021
OEM Part #47-5
OIL SEAL
Fits: Shaft
Models: American Orthopedic Cast Cutter;
 Autopsy Saw: 810 & 811;
 Cast Cutter: 840, 841, 848 & 851



RPI Part #STB004
OEM Part #81-147
NEEDLE BEARING
 • Hardened steel outer race
 • .1575" ID x .4063" OD x .2570" wide
Fits: Cam
Models: American Orthopedic Cast Cutter;
 Autopsy Saw: 810 & 811;
 Cast Cutter: 840, 841, 848 & 851



RPI Part #STN017
OEM Part #840-1-14
SHAFT NUT
 • 1/2" hex
 • 3/8-32 thread
Fits: Shaft
Models: American Orthopedic Cast Cutter;
 Autopsy Saw: 810 & 811;
 Cast Cutter: 840, 841, 848 & 851

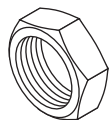

RPI Part #STB003
OEM Part #81-117
FRONT BEARING
 • 52100 steel
 • Double seal & shield
 • .3150" ID x .8661" OD x .4063" wide
Fits: Front end of Armature Shaft
Models: Autopsy Saw: 810 & 811;
 Cast Cutter: 840, 841, 848 & 851

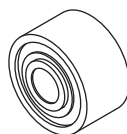

RPI Part #STB005
OEM Part #81-138
REAR BEARING
 • 52100 steel; Double seal & shield
 • .2362" ID x .7480" OD x .4063" wide
Fits: Rear end of Armature Shaft
Models: Autopsy Saw: 810 & 811;
 Cast Cutter: 840, 841, 848 & 851



Orthopedics & Physical Therapy.

American Orthopaedic™ Cast Cutter, Stryker 800 Series Autopsy Saws & Cast Cutters, and Cast Spreaders & Vacuums

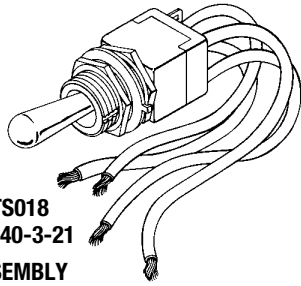

RPI Part #STS018
OEM Part #840-3-21

SWITCH ASSEMBLY

- 5 A @ 120VAC
 - On - Off toggle
 - DPDT
 - Includes 4" long wire leads and mounting hardware
- Models:** Autopsy Saw: 810 & 811;
Cast Cutter: 840, 841, 848 & 851

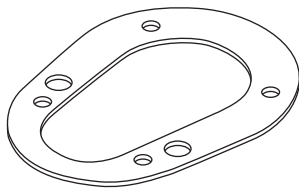

RPI Part #STG013
OEM Part #840-1-10

GASKET

- Fits:** Cover Assembly
- Models:** American Orthopedic Cast Cutter;
Autopsy Saw: 810 & 811;
Cast Cutter: 840, 841, 848 & 851



RPI Part #STD012
OEM Part #840-2-4

FELT OIL DISTRIBUTOR

- Fits:** Housing Assembly
- Models:** American Orthopedic Cast Cutter;
Autopsy Saw: 810 & 811;
Cast Cutter: 840, 841, 848 & 851

If it's an RPI part,
it's a part you
can trust.

VACUUMS

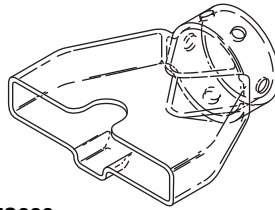

RPI Part #STG006
OEM Part #846-3-8

PLASTIC BLADE GUARD

- Mounts on Nozzle Adaptor
- Models:** "Plaster Vac" 843, 846, 855, 856,
860 & 862

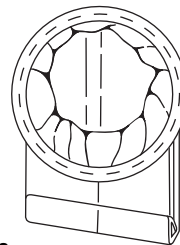

RPI Part #STB007
OEM Part #843-1-000

VACUUM BAG

- 12 per package
 - Disposable
- Fits:** Inside Cloth Bag
- Models:** "Plaster Vac" 843 & 846

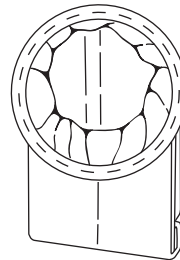

RPI Part #STB008
OEM Part #856-1-36

VACUUM BAG

- 12 per package
 - Disposable
- Fits:** Inside Cloth Bag
- Models:** "Plaster Vac" 843, 846, 855, 856,
860 & 862

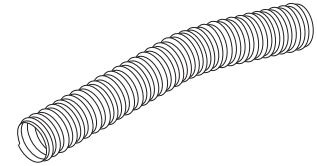

RPI Part #STH014
OEM Part #843-3-13

VACUUM HOSE

- 1-1/2" OD x 57" long
- Fits:** Standpipe Assembly
- Models:** "Plaster Vac" 843, 846, 855, 856,
860 & 862

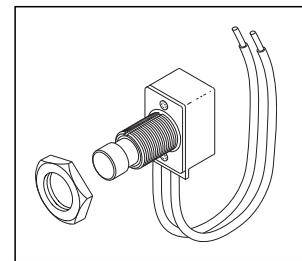

RPI Part #STS024
OEM Part #856-1-50

SWITCH ASSEMBLY

- 10 A @ 125VAC, 1/3 HP
 - Push On - Push Off
 - SPST
 - Includes 6" long wire leads and mounting hardware
- Model:** "Plaster Vac" 843, 846, 855, 856,
860 & 862



RPI Part #STS022
OEM Part #843-3-23

RETAINING SCREW

- Has pointed end
- Fits:** Nozzle Adaptor (RPI Part #STG006)
- Model:** "Plaster Vac" 843, 846, 855, 856,
860 & 862

CAST SPREADERS

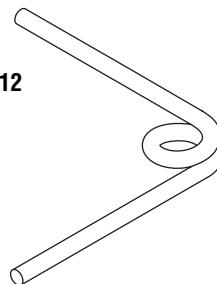

RPI Part #STS020
OEM Part #82-1-012

COIL SPRING

- Fits:** "Standard" Cast Spreader
- Model:** 82

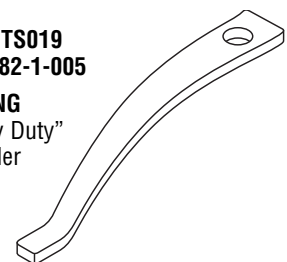

RPI Part #STS019
OEM Part #82-1-005

FLAT SPRING

- Fits:** "Heavy Duty" Cast Spreader
- Model:** 83

RPI Part #STA028
OEM Part # (No OEM Part # Available)
ARMATURE ASSEMBLY (115VAC)
 • 115 VAC
 • Includes Armature Washer Kit (RPI Part #STK033)
Models: Cast Cutter: 940

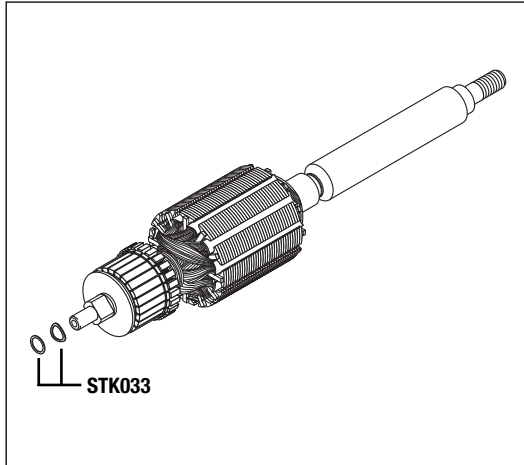

RPI Part #STK033
OEM Part # (No OEM Part # Available)
ARMATURE WASHER KIT
 • Stainless steel
 • .195" ID x .245" OD
 • Includes flat washer and wave washer
Fits: Armature
Models: Cast Cutter: 940 & 941

Also fits 800 Series!

RPI Part #STB002
OEM Part #940-1-113 (Brush only) & 38-49 (Spring only)

BRUSH
 • 2 per package
 • Size: 3/16" x 3/16" x 1/2" lg
 • Spring length: 1.000"
Fits: Brush Holder Assembly
Models: Cast Cutter: 940 & 941

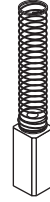

RPI Part #RPC667
OEM Part #58-18

BRUSH CAP
 • 6 per package
 • 7/16-24 thread
Models: Cast Cutter: 940 & 941



RPI Part #STB031
OEM Part # (No OEM Part # Available)
FRONT BEARING
 • Stainless steel
 • .2500" ID x .6250" OD x .1960" Wide
 • Factory oiled
 • Double shielded
Models: Cast Cutter: 940 & 941

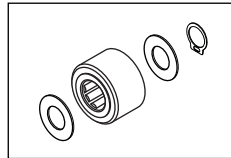

RPI Part #STK030
OEM Part #28-111 (Retaining Ring only), 11-275 (Washers only), 81-118 (Needle Bearing only)
ROLLER BEARING KIT
 Includes Needle Bearing (RPI Part #STB004), retaining ring, and (2) washer
Models: Cast Cutter: 940 & 941



RPI Part #STB032
OEM Part # (No OEM Part # Available)
REAR BEARING
 • Stainless steel
 • .1875" ID x .5000" OD x .1960" Wide
 • Factory oiled
 • Double shielded
Models: Cast Cutter: 940 & 941

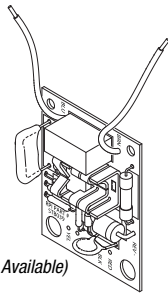

RPI Part #STB039
OEM Part # (No OEM Part # Available)
POWER SUPPLY PCB
 • 115VAC
 • Also available, Fuse (RPI Part #RPF665)
Fits: Power Supply Module
Models: 940

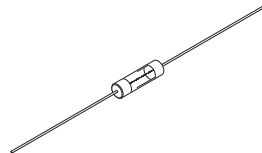

RPI Part #RPF665
OEM Part # (No OEM Part # Available)
AXIAL LEAD FUSE (2-1/2A)
 • 5 per package
 • Amps: 2-1/2A; Volts: 250V
 • Type: 2AG glass; Time Delay
 • .20" dia. x .58" lg. body x 1.50" lg. leads
Fits: Power Supply Module
Models: Cast Cutter: 940

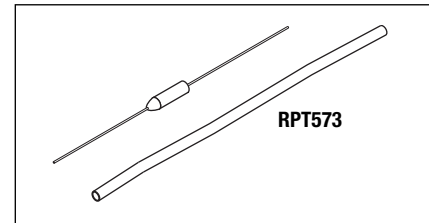

RPI Part #STF036
OEM Part # (No OEM Part # Available)
THERMAL FUSE (104°C)
 • Opens at 104°C
 • Includes (1 piece) Heat Shrink Tubing (RPI Part #RPT573)
Models: Cast Cutter: 940 & 941



Now can be used with 800 & 900 Series!



RPI Part #STT010
OEM Part # (No OEM Part # Available)
CAM TOOL
 • Use to install and remove Cam (RPI Part #STC029 & STC009)
 • ~ 3/4" dia. x 2" lg
 • Stainless steel
 • 5/16" dia. thru hole for crossbar leverage
Models: Cast Cutter: 940 & 941

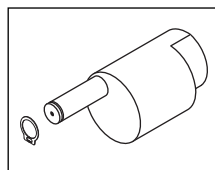

RPI Part #STC029
OEM Part # (No OEM Part # Available)
CAM
 • Hardened steel
 • Includes retaining ring
 • For ease of installation/removal use Cam Tool (RPI Part #STT010)
Models: Cast Cutter: 940 & 941

RPI parts are guaranteed to YOUR 100% Complete Satisfaction!



Did You Know ...
 To access the housing for the Stryker 900 series cast cutters, simply remove the screws located under the Power Switch Label and cap.

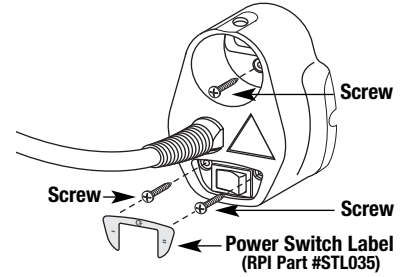

RPI Part #STS034
OEM Part #
 (No OEM Part # Available)

POWER SWITCH

- SPDT
- 6A @ 125-250VAC
- 1/4" tabs
- Center Off rocker - Black
- Includes (1 piece) Heat Shrink Tubing (RPI Part #RPT573) and (1 piece) Power Switch Label (RPI Part # STL035)
- Use Silicone Gasket Maker 598 (RPI Part #RPS639) to seal switch connections

Models: Cast Cutter: 940 & 941

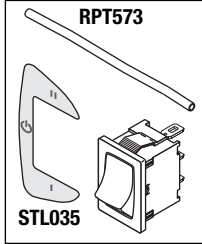

RPI Part #STL035
OEM Part # (No OEM Part # Available)

POWER SWITCH LABEL

- 3 per package
- Grey polycarbonate
- Use to cover case screws

Models: Cast Cutter: 940 & 941

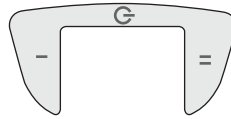

Perfect for sealing Power Switch connections!

RPI Part #RPS639
OEM Part # (No OEM Part # Available)

SILICONE GASKET MAKER 598

- .5 fl. oz.
- Material: RTV black silicone
- Provides a sealant for pump tubing connections or can be used to seal power switch connections

Models: Cast Cutter: 940 & 941

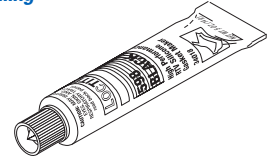

RPI Part #STK037
OEM Part # (No OEM Part # Available)

POWER CABLE KIT

- Includes (1 piece) 10' pre-stripped and tinned Cable (RPI Part #RPC671), Heat Shrink Tubing (RPI Part #RPT573), (2 pieces) Cable Tie (RPI Part #RPT083), and (2 pieces) Strain Relief Bushing (RPI Part #STB038) as shown

Models: Cast Cutter: 940 & 941

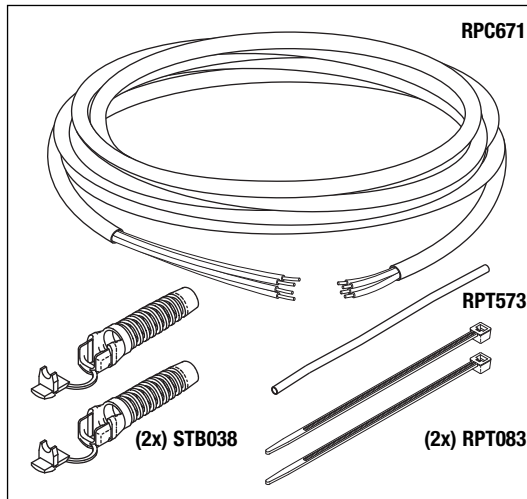

RPI Part #RPC671
OEM Part # (No OEM Part # Available)

CABLE (4 CONDUCTOR)

- 4 conductor 20 AWG 19/32
- Colors: black, red, green, and yellow
- White PVC jacket, UL 2464, 221°F (105°C), 300V
- .25" OD cord
- Sold by the foot (reel not included)

Models: Cast Cutter: 940 & 941

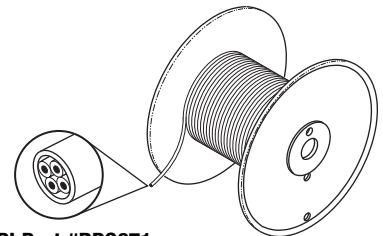

RPI Part #STB038
OEM Part # (No OEM Part # Available)

STRAIN RELIEF BUSHING

- 5 per package
- Type: SR-5P-7; Material: white Nylon®
- Cord type: round cable
- Cord OD range: .250" - .290"
- Mounting hole: 1/2"
- Install using Strain Relief Bushing Pliers (RPI Part #RPT172)

Models: Cast Cutter: 940 & 941

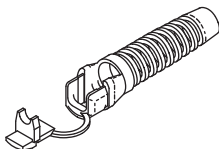

RPI Part #RPT172
OEM Part # (No OEM Part # Available)

STRAIN RELIEF BUSHING PLIERS

- Hand pliers adjustable for all bushings that assemble into mounting hole up to 7/8" dia.
- ~7" lg.

Models: Cast Cutter: 940 & 941

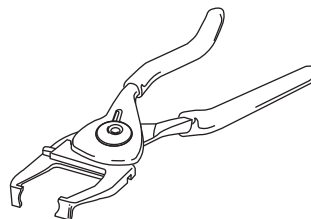

RPI Part #RPS672
OEM Part # (No OEM Part # Available)

CORD STRAP (WHITE 6")

- 3 per package
- 6" lg.
- EPDM
- White strap with white button

Models: Cast Cutter: 940 & 941

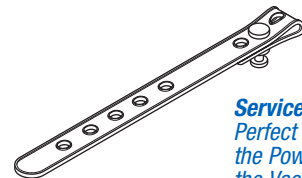

Service Tip
 Perfect for strapping the Power Cord to the Vacuum Hose!



RPI Part #STA040
OEM Part #12-24, 21-129, 45-29, 50-33,
940-1-115, 940-1-118, 940-1-125

OUTPUT DRIVE ASSEMBLY

- Includes:
 O-ring (RPI Part #RPO335),
 Bearing Grease (RPI Part #RPL680),
 T-15 Torx Wrench (RPI Part #RPT700)
 and Hardware as shown
- Anodized aluminum housing; Hardened steel shaft and shaft link
- Includes Shaft Link (RPI Part #STL016) already installed

Fits: Cast Cutter Housing
Models: Cast Cutter: 940 & 941

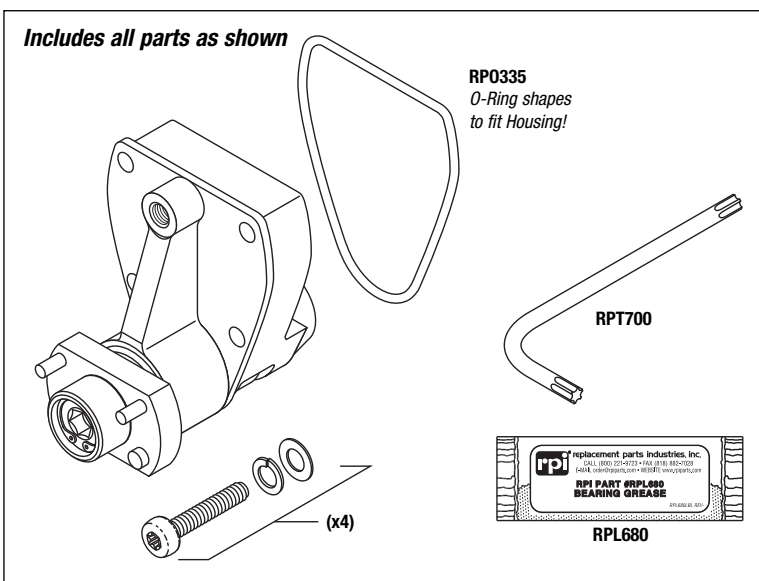

RPI Part #RPO335
OEM Part #45-29
Industry Part #AS568-029

O-RING

- 12 per package
- 1.489" ID x 1.629" OD x .070" C/S
- Material: Nitrile (Buna N)
- Duro:70

Fits: Output Drive Assembly
Models: Cast Cutter: 940 & 941



Includes (5) 0.068 fl. oz. packs



RPI Part #RPL680
OEM Part # (No OEM Part # Available)

BEARING GREASE

- 5 per package
- 0.068 fl. oz. per unit
- -54°C (-65°F) to 177°C (350°F)
- Material: Mobilith SHC100; Red synthetic grease
- MSDS and Technical Data Sheet available on RPI website

Fits: Head Assembly, Shaft Link
Models: Cast Cutter: 940 & 941

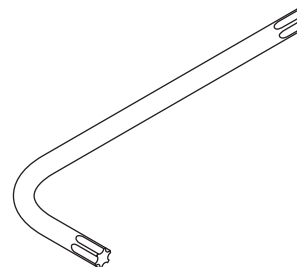

RPI Part #RPT700
OEM Part # (No OEM Part # Available)

T-15 TORX WRENCH

- Size: T-15 x 2-1/8" lg.
- Steel

Fits: Output Housing Hardware
Models: Cast Cutter: 940 & 941



Now can be used with 800 & 900 Series!

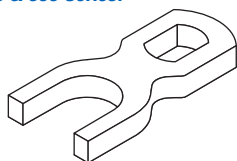

RPI Part #STL016
OEM Part # (No OEM Part # Available)

SHAFT LINK

- Hardened steel
- Presses onto shaft

Models: Cast Cutter: 940 & 941



RPI Part #PHC015
OEM Part # (No OEM Part # Available)

RETAINING CLIP

- 5 per package
- Stainless steel
- 1/4" ID

Models: Cast Cutter: 940 & 941

Orders placed before 2:00 P.M. (Pacific Time) will be shipped the same day.

Parts to fit Stryker 900 Series Cast Cutters!

RPI Part #STB043
OEM Part #940-25

CAST CUTTER BLADE

- For plaster casts
- Size: 2.36" oval blade
- Material: Stainless steel
- Also available: Cast Cutter Blade (TiN) (RPI Part #STB045) and Blade Guard (RPI Part #STG042)

Fits: Head Assembly
Models: 940 & 941

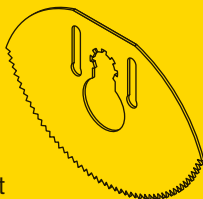

For Plaster Casts!

RPI Part #STB045
OEM Part #940-35

CAST CUTTER BLADE (TiN)

- For both plaster and synthetic casts
- Size: 2.36" oval blade
- Material: Titanium nitride coated stainless steel
- Also available: Cast Cutter Blade (RPI Part #STB043) and Blade Guard (RPI Part #STG042)

Fits: Head Assembly
Models: 940 & 941

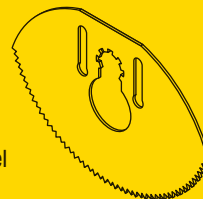

For Synthetic & Plaster Casts!

RPI Part #STG042
OEM Part #940-1-134

BLADE GUARD

- Fits: 2.36" oval blade
- Material: Clear plastic
- Includes: Mounting hardware
- Also available: Cast Cutter Blade (RPI Part #STB043) and Cast Cutter Blade (TiN) (RPI Part #STB045)

Fits: Head Assembly
Models: 940 & 941



RPI Part #STF044
OEM Part #986-500

CARTRIDGE FILTER

- 11 micron
- Size: 7.00" dia. x 11.38" lg.
- Includes: Filter with O-Ring

Fits: Vacuum Canister
Models: 986

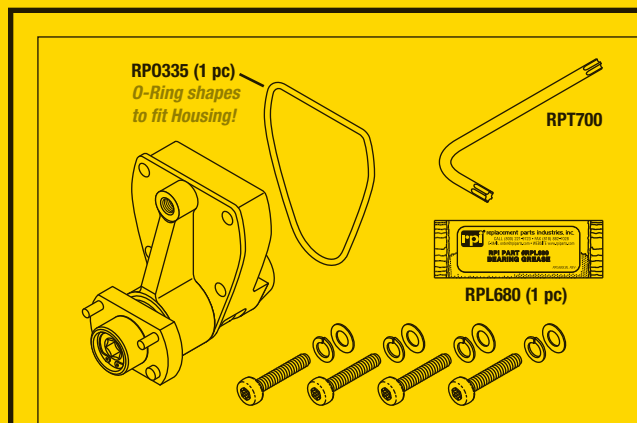
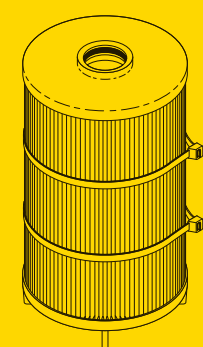

RPI Part #STA040
OEM Part #12-24, 21-129, 45-29, 50-33,
940-1-115, 940-1-118, 940-1-125

OUTPUT DRIVE ASSEMBLY

- Includes: (1 pc) O-ring (RPI Part #RPO335), (1 pc) Bearing Grease (RPI Part #RPL680), T-15 Torx Wrench (RPI Part #RPT700) and hardware. Also includes Shaft Link (RPI Part #STL016) and (1 pc) Retaining Clip (RPI Part #PHC015) already installed
- Material: Anodized aluminum housing; Hardened steel shaft and shaft link

Fits: Cast Cutter Housing
Models: 940 & 941

RPI Part #RP0335
OEM Part #45-29

O-RING

- 12 per package
- Material: Nitrile (Buna N), Duro:70
- 1.489" ID x 1.629" OD x .070" C/S

Fits: Output Drive Assembly
Models: 940 & 941



RPI Part #RPL680
OEM Part # (No OEM Part # Available)

BEARING GREASE

- 5 per package; 0.068 fl. oz. per unit
- Material: Mobilith SHC100; Red synthetic grease

Fits: Head Assembly, Shaft Link
Models: 940 & 941



RPI Part #RPT700
OEM Part # (No OEM Part # Available)

T-15 TORX WRENCH

- Material: Steel; • Size: T-15 x 2-1/8" lg.

Fits: Output Housing Hardware
Models: 940 & 941

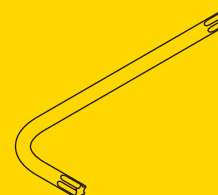

replacement parts industries, inc.

CALL (800) 221-9723 • FAX (818) 882-7028 • EMAIL order@riparts.com • WEBSITE www.riparts.com

The above parts are manufactured by Replacement Parts Industries, Inc. to fit the equipment noted. All product names used in this document are trademarks or registered trademarks of their respective holders. 1904AM Show 01/21

RPI Part #STA028
OEM Part # (No OEM Part # Available)
ARMATURE ASSEMBLY (115VAC)
 • 115 VAC
 • Includes all parts as shown
Models: 940

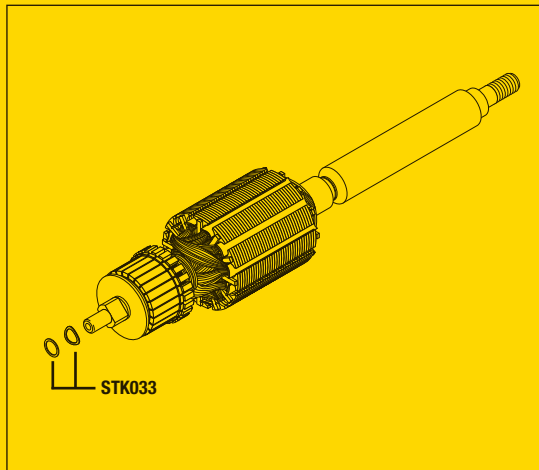

RPI Part #STB002
OEM Part #940-1-113 (Brush only)
 & 38-49 (Spring only)
BRUSH
 • 2 per package
 • Size: 3/16" x 3/16" x 1/2" lg
 • Spring length: 1.000"
Fits: Brush Holder Assembly
Models: 940 & 941

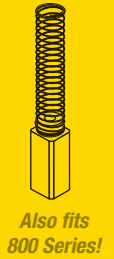

RPI Part #STK033
OEM Part # (No OEM Part # Available)
ARMATURE WASHER KIT
 • Material: Stainless steel
 • .195" ID x .245" OD
 • Includes flat washer and wave washer
Fits: Armature
Models: 940 & 941

RPI Part #RPC667
OEM Part #58-18
BRUSH CAP
 • 6 per package; 7/16-24 thread
Models: 940 & 941



RPI Part #STB031
OEM Part # (No OEM Part # Available)
FRONT BEARING
 • Material: Stainless steel
 • .2500" ID x .6250" OD x .1960" Wide
 • Factory greased; Double shielded
Models: 940 & 941



RPI Part #STK030
OEM Part #28-111 (Retaining Ring only), 11-275 (Washers only), 81-118/81-147 (Needle Bearing only)
ROLLER BEARING KIT
 Includes: Needle Bearing (RPI Part #STB004), retaining ring, and (2) washer
Models: 940 & 941

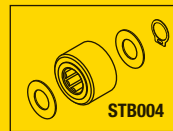

RPI Part #STB032
OEM Part # (No OEM Part # Available)
REAR BEARING
 • Material: Stainless steel
 • .1875" ID x .5000" OD x .1960" Wide
 • Factory greased; Double shielded
Models: 940 & 941



RPI Part #STB004
OEM Part #81-118/81-147
NEEDLE BEARING
 • Hardened steel outer race
 • .1575" ID x .4063" OD x .2570" wide
 • Included in: Roller Bearing Kit (RPI Part #STK030)
Fits: Cam
Models: 940 & 941



Also fits 800 Series!

RPI Part #STB039
OEM Part # (No OEM Part # Available)
POWER SUPPLY PCB
 • 115VAC
 • Also available: Fuse (RPI Part #RPF665)
Fits: Power Supply Module
Models: 940

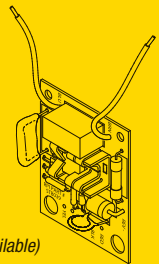

RPI Part #RPF665
OEM Part #
 (No OEM Part # Available)

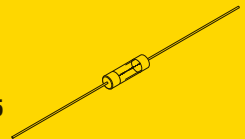

AXIAL LEAD FUSE (2-1/2A)
 • 5 per package
 • Amps: 2-1/2A; Volts: 250V
 • Type: 2AG glass; Time Delay
 • .20" dia. x .58" lg. body x 1.50" lg. leads
Fits: Power Supply Module
Models: 940

RPI Part #STT010
OEM Part # (No OEM Part # Available)
CAM TOOL
 • Use to install and remove Cam (RPI Part #STC029 & STC009)
 • 3/4" dia. x 2" lg.
 • Material: Stainless steel
Models: 940 & 941

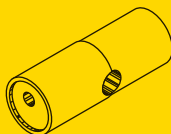

Can be used with 800 & 900 Series!

RPI Part #STL016
OEM Part # (No OEM Part # Available)
SHAFT LINK
 • Material: Hardened steel
 • Presses onto shaft
 • Included in: Output Drive Assembly (RPI Part #STA040)
 • Also available: Retaining Clip (RPI Part #PHC015)
Models: 940 & 941



Can be used with 800 & 900 Series!

RPI Part #STC029
OEM Part # (No OEM Part # Available)
CAM
 • Material: Hardened steel
 • Includes: Retaining ring
 • For ease of installation and removal use Cam Tool (RPI Part #STT010)
Models: 940 & 941

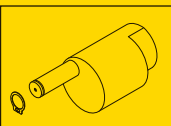

RPI Part #PHC015
OEM Part # (No OEM Part # Available)
RETAINING CLIP
 • 5 per package
 • Material: Stainless steel; 1/4" ID
 • Included in: Output Drive Assembly (RPI Part #STA040)
 • Also available: Shaft Link (RPI Part #STL016)
Models: 940 & 941

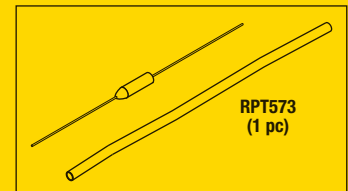

RPI Part #STF036
OEM Part # (No OEM Part # Available)
THERMAL FUSE (104°C)
 • Opens at 104°C
 • Includes (1 piece) Heat Shrink Tubing (RPI Part #RPT573)
Models: 940 & 941

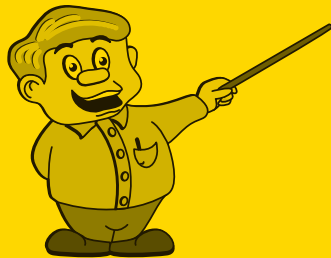

Did You Know ...

To access the housing for the Stryker 900 series cast cutters, simply remove the screws located under the Power Switch Label and cap.

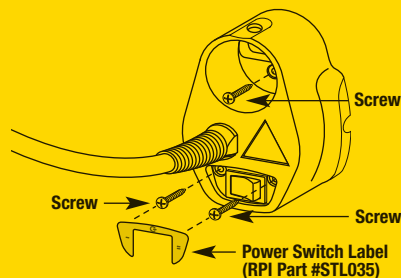

RPI Part #STS034
OEM Part #
(No OEM Part # Available)

POWER SWITCH

- SPDT
- 6A @ 125-250VAC
- 1/4" tabs
- Center Off rocker - Black
- Includes (1 pc) Heat Shrink Tubing (RPI Part #RPT573) and (1 pc) Power Switch Label (RPI Part # STL035)
- Use Adhesive (RTV108) (RPI Part #RPA874) to seal switch connections

Models: 940 & 941

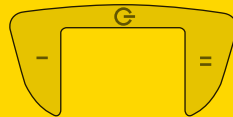
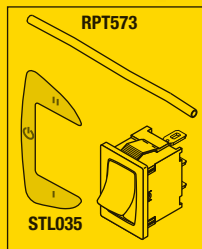

RPI Part #STL035
OEM Part # *(No OEM Part # Available)*

POWER SWITCH LABEL

- 3 per package
- Grey polycarbonate with adhesive backing
- Use to cover case screws

Models: 940 & 941

Perfect for sealing Power Switch connections!

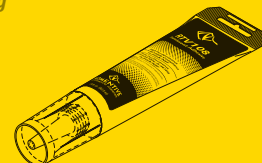

RPI Part #RPA874
OEM Part # *(No OEM Part # Available)*

ADHESIVE (RTV108)

- Size: 2.8 fl. oz. tube
- Translucent silicone adhesive/sealant
- Temperature Range: -75°F to +400°F
- Can be used to seal power switch connections

Models: 940 & 941

RPI Part #STK037
OEM Part # *(No OEM Part # Available)*

POWER CABLE KIT

- Includes (1 pc) 10' prestripped and tinned Cable (RPI Part #RPC671), Heat Shrink Tubing (RPI Part #RPT573), (2 pcs) Cable Tie (RPI Part #RPT083), and (2 pcs) Strain Relief Bushing (RPI Part #STB038) as shown

Models: 940 & 941

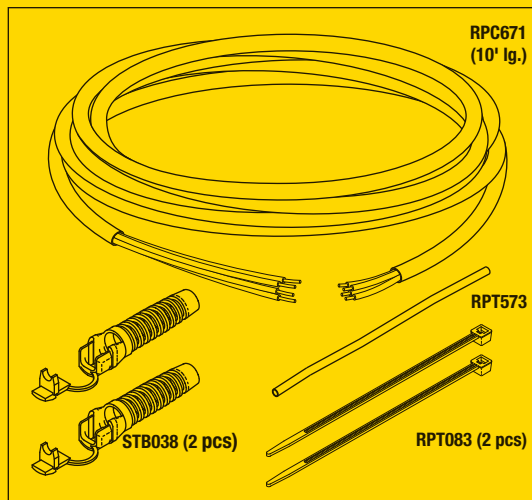

RPI Part #RPC671
OEM Part # *(No OEM Part # Available)*

CABLE (4 CONDUCTOR)

- 4 conductor #20 AWG 19/32
- Colors: Black, red, green, and yellow
- White PVC jacket, UL 2464, 221°F (105°C), 300V
- .25" OD cord
- Sold by the foot (reel not included)

Models: 940 & 941

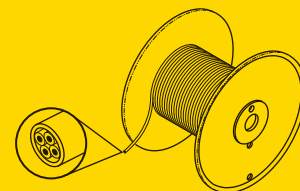

RPI Part #STB038
OEM Part # *(No OEM Part # Available)*

STRAIN RELIEF BUSHING

- 5 per package
- Type: SR-5P-7; Material: white Nylon®
- Cord type: round cable
- Cord OD range: .250" - .290"
- Mounting hole: 1/2"
- Also available: Strain Relief Bushing Pliers (RPI Part #RPT172)

Models: 940 & 941

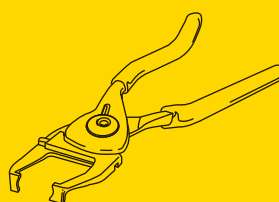
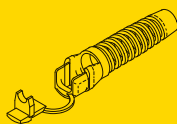

RPI Part #RPT172
OEM Part # *(No OEM Part # Available)*

STRAIN RELIEF BUSHING PLIERS

- Hand pliers adjustable for all bushings that assemble into mounting hole up to 7/8" dia.
- Size: 7" lg.

Models: 940 & 941

Service Tip
Perfect for strapping the Power Cord to the Vacuum Hose!

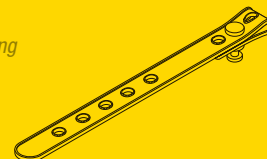

RPI Part #RPS672
OEM Part # *(No OEM Part # Available)*

CORD STRAP (WHITE 6")

- 3 per package
- 1/2" wide x 6" lg.
- EPDM
- White strap with white button

Models: 940 & 941

RPI has New Parts to fit Stryker 900 Series Cast Cutters!

For Plaster Casts!

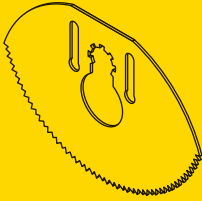

RPI Part #STB043
OEM Part #940-25

CAST CUTTER BLADE
Models: 940 & 941

For Synthetic & Plaster Casts!

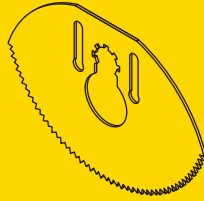

RPI Part #STB045
OEM Part #940-35

CAST CUTTER BLADE (TiN)
Models: 940 & 941

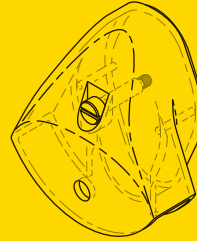

RPI Part #STG042
OEM Part #940-1-134

BLADE GUARD
Models: 940 & 941

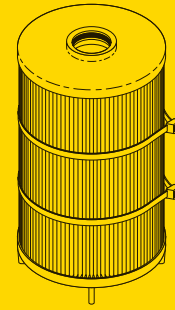

RPI Part #STF044
OEM Part #986-500

CARTRIDGE FILTER
Models: 986

New Parts to fit Stryker 900 Series Cast Cutters!

ADDRESS SERVICES REQUESTED

replacement parts industries, inc.
625 Cochran Street • Simi Valley, California • 93065



PRESORTED STANDARD
U.S. POSTAGE PAID
VAN NUYS, CA
PERMIT NO. 2399

Don't forget ... RPI also has parts to fit Stryker 800 Series Autopsy Saws, Cast Cutters and Vacuums!

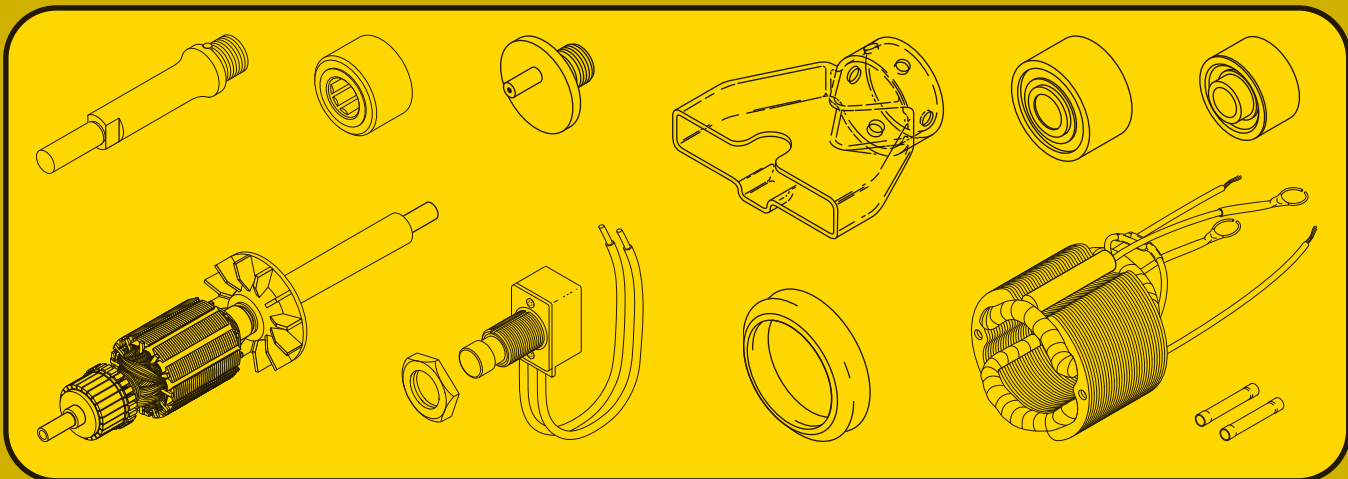



Parts to fit
Stryker® 900 Series
Cast Cutters!



For Synthetic & Plaster Casts!

RPI Part #STB056
 OEM Part #940-23

CAST CUTTER BLADE (PiN)

- For both plaster and synthetic casts
- Size: 2.36" oval blade
- Material: Plasma ion nitride treated stainless steel
- Color: Matte grey
- Also available: Cast Cutter Blade (RPI Part #STB043), Cast Cutter Blade (TiN) (RPI Part #STB045), and Blade Guard (RPI Part #STG042)

Fits: Head Assembly
Models: 940 & 941



For Plaster Casts!

RPI Part #STB043
 OEM Part #940-25

CAST CUTTER BLADE

- For plaster casts
- Size: 2.36" oval blade
- Material: Stainless steel
- Color: Silver
- Also available: Cast Cutter Blade (TiN) (RPI Part #STB045), Cast Cutter Blade (PiN) (RPI Part #STB056), and Blade Guard (RPI Part #STG042)

Fits: Head Assembly
Models: 940 & 941



For Synthetic & Plaster Casts!

RPI Part #STB045
 OEM Part #940-35

CAST CUTTER BLADE (TiN)

- For both plaster and synthetic casts
- Size: 2.36" oval blade
- Material: Titanium nitride coated stainless steel
- Color: Gold
- Also available: Cast Cutter Blade (RPI Part #STB043), Cast Cutter Blade (PiN) (RPI Part #STB056), and Blade Guard (RPI Part #STG042)

Fits: Head Assembly
Models: 940 & 941



RPI Part #STG042
 OEM Part #940-1-134

BLADE GUARD

- Fits: 2.36" oval blade
- Material: Clear blue plastic
- Includes: Mounting hardware
- Also available: Cast Cutter Blade (RPI Part #STB043), Cast Cutter Blade (TiN) (RPI Part #STB045), and Cast Cutter Blade (PiN) (RPI Part #STB056)

Fits: Head Assembly
Models: 940 & 941

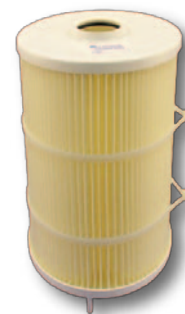

RPI Part #STF044
 OEM Part #986-500

CARTRIDGE FILTER

- 11 micron
- Size: 7.00" dia. x 11.38" lg.
- Includes: Filter with O-Ring

Fits: Vacuum Canister
Models: 986 Plaster Vacuum

For more RPI parts to fit Stryker 800 and 900 Series Cast Cutters as well as 800 Series Autopsy Saws, be sure to see the next page!

Complete List of RPI Parts to fit Stryker® 800 & 900 Series Cast Cutters and 800 Series Autopsy Saws!

RPI Part #	OEM Part #	Description	800 & 900 Series Cast Cutters						986 Plaster Vacuum	800 Series Autopsy Saws	
			840	841	848	851	940	941	986	810	811
PHC015	875-033007	Retaining Clip - 5/Pkg					X	X			
RPC039	<i>(No OEM Part # Available)</i>	Brush Cap - 6/Pkg	X	X	X	X				X	X
RPC667	58-18	Brush Cap - 6/Pkg					X	X			
RPC671	<i>(No OEM Part # Available)</i>	Cable (4 Conductor)					X	X			
RPF665	<i>(No OEM Part # Available)</i>	Axial Lead Fuse (2-1/2A) - 5/Pkg					X				
RPL680	<i>(No OEM Part # Available)</i>	Bearing Grease - 5/Pkg					X	X			
RPO335	45-29	O-Ring - 12/Pkg					X	X			
RPS639	<i>(No OEM Part # Available)</i>	Silicone Gasket Maker 598					X	X			
RPS672	<i>(No OEM Part # Available)</i>	Cord Strap (White 6") - 3/Pkg					X	X			
RPT172	<i>(No OEM Part # Available)</i>	Strain Relief Bushing Pliers					X	X			
RPT700	<i>(No OEM Part # Available)</i>	T-15 Torx Wrench					X	X			
STA026	870-1-8	Armature Assembly	X		X					X	
STA028	<i>(No OEM Part # Available)</i>	Armature Assembly					X				
STA040	12-24, 21-129, 45-29, 50-33, 940-1-115, 940-1-118 & 940-1-125	Output Drive Assembly					X	X			
STB002	870-1-13, 940-1-113 (Brush only), 38-49 (Spring only)	Brush - 2/Pkg	X	X	X	X	X	X		X	X
STB003	81-117	Front Bearing	X	X	X	X				X	X
STB004	81-118/81-147	Needle Bearing	X	X	X	X	X	X		X	X
STB005	81-138	Rear Bearing	X	X	X	X				X	X
STB015	840-25-11	Cast Cutter Blade (2-1/2")	X	X	X	X					
STB031	<i>(No OEM Part # Available)</i>	Front Bearing					X	X			
STB032	<i>(No OEM Part # Available)</i>	Rear Bearing					X	X			
STB038	<i>(No OEM Part # Available)</i>	Strain Relief Bushing - 5/Pkg					X	X			
STB039	<i>(No OEM Part # Available)</i>	Power Supply PCB					X				
STB043	940-25	Cast Cutter Blade					X	X			
STB045	940-35	Cast Cutter Blade (TiN)					X	X			
STB056	940-23	Cast Cutter (PiN)					X	X			
STC009	840-2-7	Cam	X	X	X	X				X	X
STC011	840-1-13	Collar	X	X	X	X				X	X
STC029	<i>(No OEM Part # Available)</i>	Cam					X	X			
STD012	840-2-4	Felt Oil Distributor	X	X	X	X				X	X
STF027	840-3-32	Field Assembly	X		X					X	
STF036	<i>(No OEM Part # Available)</i>	Thermal Fuse (104°C)					X	X			
STF044	986-500	Cartridge Filter							X		
STG013	840-1-10	Gasket	X	X	X	X				X	X
STG042	940-1-134	Blade Guard					X	X			
STK030	28-111 (Retaining Ring only), 11-275 (Washer only), 81-118/ 81-147 (Needle Bearing only)	Roller Bearing kit					X	X			
STK033	<i>(No OEM Part # Available)</i>	Armature Washer Kit					X	X			
STK037	<i>(No OEM Part # Available)</i>	Power Cable Kit					X	X			
STL016	840-1-5 (800 Series only)	Shaft Link	X	X	X	X	X	X		X	X
STL035	<i>(No OEM Part # Available)</i>	Power Switch Label - 3/Pkg					X	X			
STN017	840-1-14	Shaft Nut	X	X	X	X				X	X
STS018	840-3-21	Switch Assembly	X	X	X	X				X	X
STS021	47-5	Oil Seal	X	X	X	X				X	X
STS023	870-1-3	Shaft	X	X	X	X					
STS034	<i>(No OEM Part # Available)</i>	Power Switch Label - 3/Pkg					X	X			
STT010	<i>(No OEM Part # Available)</i>	Cam Tool	X	X	X	X	X	X		X	X
STW025	13-4	Internal Tooth Washer	X	X	X	X				X	X



... Proud to be a Healthcare Components Group company ...



HEALTHCARE
Components Group

STRYKER

New Parts to fit

Stryker® 900 Series

Plaster Vacuums & Cast Cutters

Did You Know?

To remove the case screws for the Stryker 986 CastVac™, simply remove the perforated aluminum plate to access the Nylok nuts. Note: Removing the perforated aluminum plate will rip/tear the Motor Gasket (RPI Part #STG049).

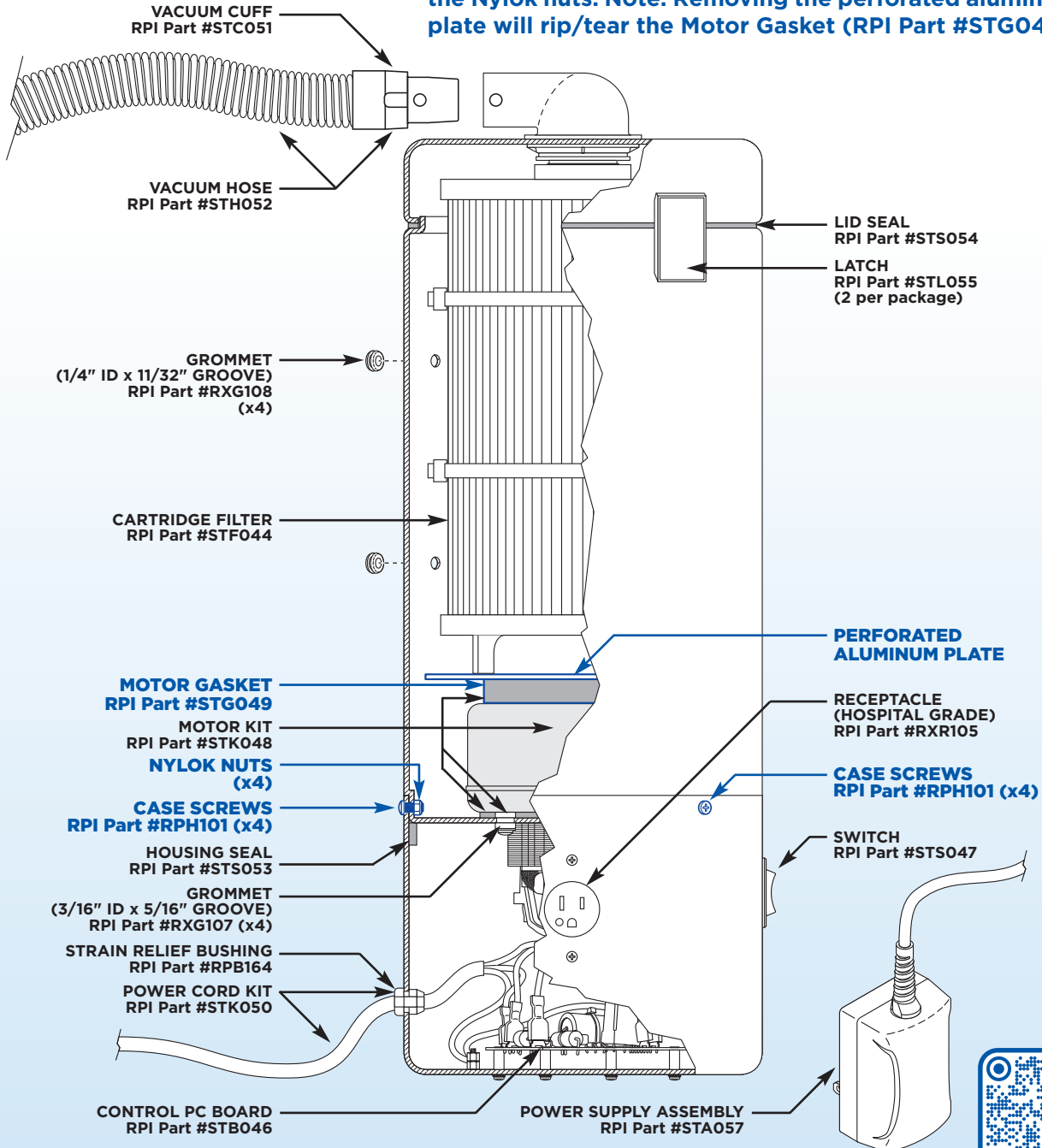

replacement parts industries, inc. A Healthcare Components Group Company

CALL (800) 221-9723 • FAX (818) 882-7028 • EMAIL order@rpiparts.com • WEBSITE www.rpiparts.com

The above parts are manufactured by Replacement Parts Industries, Inc. to fit the equipment noted. All product names used in this document are trademarks or registered trademarks of their respective holders. 2131ST Web 01/23

SECTION
9

PAGE
308

UPDATED
01/23

rpi Parts to fit Stryker® 900 Series Plaster Vacuums

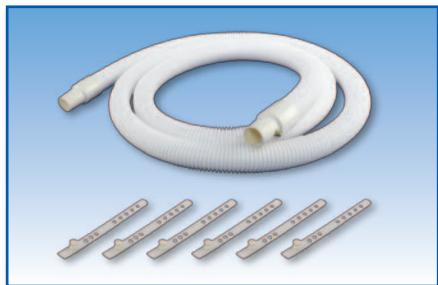

RPI Part #STH052
OEM Part #986-1-30

VACUUM HOSE

- 104" lg., 1.0" OD, White
- Includes: (2 pcs) Vacuum Cuff (RPI Part #STC051) and (6 pcs) Cord Strap (White 6") (RPI Part #RPS672)

Fits: Chassis

Models: 986, 987 & 996



RPI Part STK048
OEM Part # (No OEM Part # Available)

MOTOR KIT

- 120VAC, thru-flow discharge, single speed, double ball bearings
- Includes: Motor Gasket (RPI Part #STG049), (1 pkg) Grommet (3/16" ID x 5/16" Groove) (RPI Part #RXG107), and mounting hardware

Fits: Chassis

Models: 986 & 987



x2

RPI Part #STC051
OEM Part # (No OEM Part # Available)

VACUUM CUFF

- 2 per package
- Size: 1" dia., white TPE
- Includes: Lock button and spring
- Included in: Vacuum Hose (RPI Part #STH052)

Fits: Vacuum Hose

Models: 986, 987 & 996

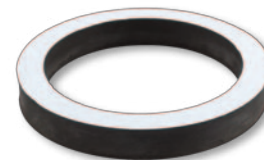

RPI Part #STG049
OEM Part # (No OEM Part # Available)

MOTOR GASKET

- Size: 4.00" ID x 5.00" OD x .63" thk., PSA on top and bottom with release liner
- Material: Polyurethane closed cell foam
- Included in: Motor Kit (RPI Part #STK048)

Fits: Motor

Models: 986, 987 & 996

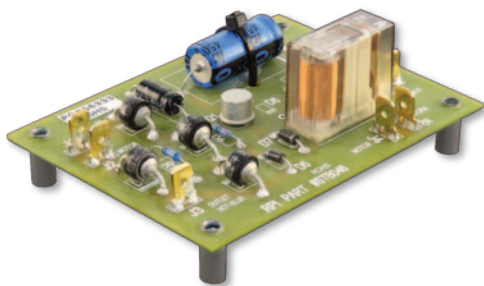

RPI Part #STB046
OEM Part # (No OEM Part # Available)

CONTROL PC BOARD

- Size: 4.00" x 3.00"
- Includes: Installed 1/4" quick connect terminals and #6-32 x .50" threaded standoffs

Fits: Chassis

Models: 986 & 987

RPI Part #STF044
OEM Part #986-500

CARTRIDGE FILTER

- 11 micron
- Size: 7.00" dia. x 11.38" lg.
- Includes: Filter with O-Ring

Fits: Vacuum Canister

Models: 986 Plaster Vacuum

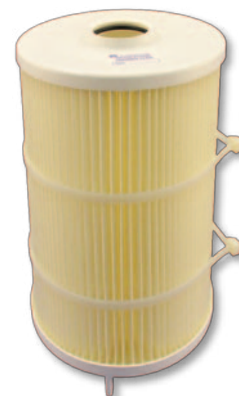



Parts to fit Stryker® 900 Series Plaster Vacuums

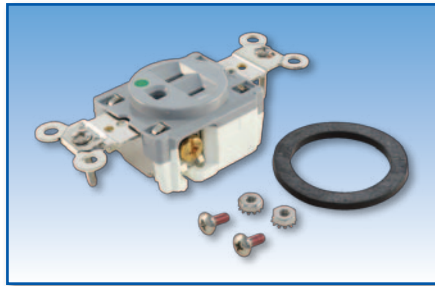

RPI Part #RXR105

OEM Part # (No OEM Part # Available)

RECEPTACLE (HOSPITAL GRADE)

- Single hospital grade receptacle; Color: Grey
- Includes: Sealing gasket with PSA and mounting hardware as shown

Fits: Chassis

Models: 986, 987 & 996

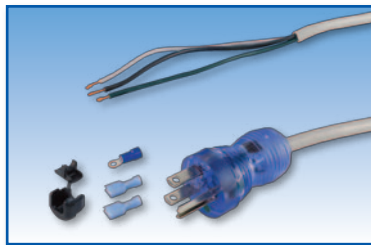

RPI Part #STK050

OEM Part # (No OEM Part # Available)

POWER CORD KIT

- 12 ft. lg., 16/3 SJT, hospital grade 5/15, gray
- Includes: (1 pc) Strain Relief Bushing (RPI Part #RPB164), (2 pcs) QC Terminal (1/4 Female) (RPI Part #RPT472), and (1 pc) #6 Ring Terminal (RPI Part #RPT005)
- Also available: Strain Relief Bushing Pliers (RPI Part #RPT172)

Fits: Chassis

Models: 986



x8

RPI Part #RPB164

OEM Part # (No OEM Part # Available)

STRAIN RELIEF BUSHING

- 8 per package
- Type: SR-6N3-4
- Accommodates: .325" - .360" dia. round cable.
- Mounting Hole: 5/8" dia. x 1/8" thk. panel max.
- Included in: Power Cord Kit (RPI Part #STK050)
- Also available: Strain Relief Bushing Pliers (RPI Part #RPT172)

Fits: Vacuum Housing

Models: 986, 987 & 996



RPI Part #STL055

OEM Part # (No OEM Part # Available)

LATCH

- 2 per package
- Low profile one piece molded polypropylene; Color: Black
- Includes: Latch, keeper, and mounting hardware

Fits: Vacuum Canister Housing and Lid

Models: 986, 987 & 996



RPI Part #STS047

OEM Part # (No OEM Part # Available)

SWITCH

- Rocker switch (On-Off-On)
- 20A @ 125-277VAC; DPDT
- 1/4" tabs
- Panel Cutout: .830" x 1.450", .04" - .25" thk. panel

Fits: Vacuum Canister

Models: 986, 987 & 996



x4

RPI Part #RXG107

OEM Part # (No OEM Part # Available)

GROMMET (3/16" ID X 5/16" GROOVE)

- 4 per package
- Material: Rubber, 55 Duro; Color: Black
- Included in: Motor Kit (RPI Part #STK048)

Fits: Motor Housing

Models: 986, 987 & 996



x4

RPI Part #RXG108

OEM Part # (No OEM Part # Available)

GROMMET (1/4" ID X 11/32" GROOVE)

- 4 per package
- Material: Rubber, 55 Duro; Color: Black

Fits: Vacuum Housing

Models: 986, 987 & 996

rpi Parts to fit Stryker® 900 Series Plaster Vacuums

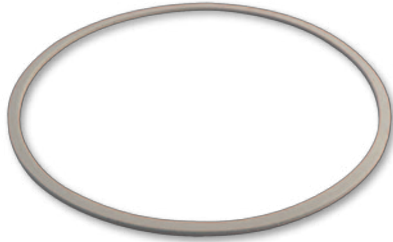

RPI Part #STS054

OEM Part # (No OEM Part # Available)

LID SEAL

- Size: 8.12" ID x 8.62" OD x 1/8" thk.
- Material: Grey closed cell vinyl foam with PSA backing
- Also available: Housing Seal (RPI Part #STS053)

Fits: Chassis

Models: 986, 987 & 996



RPI Part #STS053

OEM Part # (No OEM Part # Available)

HOUSING SEAL

- Size: 1/2" wide x 28.0" lg. x 1/8" thk.
- Material: Black closed cell foam with PSA backing
- Includes: Installation template
- Also available: Lid Seal (RPI Part #STS054)

Fits: Chassis

Models: 986, 987 & 996

rpi Parts to fit Stryker® 900 Series Cast Cutters

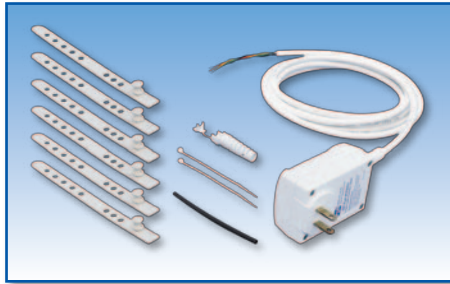

RPI Part #STA057

OEM Part # (No OEM Part # Available)

POWER SUPPLY ASSEMBLY

- Includes: Power Supply PCB (RPI Part #STB039), Power Cable Kit (RPI Part #STK037) and (6 pcs) Cord Strap (White 6") (RPI Part #RPS672)

Fits: Cast Saw Body

Models: 940

For Plaster Casts!



RPI Part #STB043

OEM Part #940-25

CAST CUTTER BLADE

- For plaster casts
- Size: 2.36" oval blade
- Material: Stainless steel
- Color: Silver
- Also available: Blade Guard (RPI Part #STG042)

Fits: Head Assembly

Models: 940 & 941

For Synthetic & Plaster Casts!



RPI Part #STB056

OEM Part #940-23

CAST CUTTER BLADE (PiN)

- For both plaster and synthetic casts
- Size: 2.36" oval blade
- Material: Plasma ion nitride treated stainless steel
- Color: Matte grey
- Also available: Blade Guard (RPI Part #STG042)

Fits: Head Assembly

Models: 940 & 941

For Synthetic & Plaster Casts!



RPI Part #STB045

OEM Part #940-35

CAST CUTTER BLADE (TiN)

- For both plaster and synthetic casts
- Size: 2.36" oval blade
- Material: Titanium nitride coated stainless steel
- Color: Gold
- Also available: Blade Guard (RPI Part #STG042)

Fits: Head Assembly

Models: 940 & 941