

OEM MODEL Section 4 Page #'s

DENTAL CHAIRS

A-DEC

Cascade 1040	200-203
Decade 1010	200-203
Decade 1011	200-203
Decade 1015	200-203
Decade 1020	200-203
Decade 1021	200-203
Performer I	200-203
Performer II	200-203
Performer III	200-203
Positioner 1030	200-203
Priority 1005	200-203

DENTALEZ®

E-1	300
Elegan	300
JS	300
JSA	300
PL-100	300
PL-200	300
PLA200	300
VS	300

PELTON & CRANE

Chairman	304 & 305
Chairman 5000	306
Chairman 5010	306
Chairman 5090	306
Coachman	307
Coachman II	307

RITTER®

FL - Type: 75 Series	302 & 303
----------------------	-----------

DENTAL COMPRESSORS

AIR TECHNIQUES, APOLLO/MIDMARK®, DENTALEZ®/CUSTOM AIR/RAMVAC, JUN-AIR, MATRX/MIDMARK®, MDT MCKESSON, MIDMARK®, PELTON & CRANE & TECH WEST

INDEX TO PARTS BY COMPONENT OR TYPE OF PART

AUTO DRAINS AND FLOATS	407, 408 & 412
BELTS AND BELT TOOL	413
BOWLS (AUTO & MANUAL DRAIN)	409, 411 & 412
CAPACITORS	414
CHECK VALVES	415
CIRCUIT BREAKERS (See Power Switches & Circuit Breakers)	
COALESCING FILTER ASSEMBLIES & REPLACEMENT PARTS	407-409
COLLECTION CONTAINERS (See Oil & Collection Containers)	
COMPRESSOR HEAD COMPONENTS	419
COMPRESSOR PM KITS	400-406
- Lubricated Compressor PM Kits	400-402
- Oil-Less Compressor PM Kits	403-406
COOLING FANS & ACCESSORIES	416
DRYERS	418
DESICCANTS & DESICCANT TANK FILTERS	417
DIFFERENTIAL PRESSURE INDICATORS	407-411 & 420 (continued)

OEM MODEL Section 4 Page #'s

DENTAL COMPRESSORS (continued)

INDEX TO PARTS BY COMPONENT OR TYPE OF PART (continued)

FILTERS	407-411 & 421-426
- Air Intake Filters	421-423
- Coalescing and Particulate Filter Elements	407-411, 424 & 425
- Fresh Air Intake Filters	421-422
- Foam Inserts/Purge Filters/Purge Mufflers	422 & 426
FITTINGS	407, 408, 427 & 428
INLET & OUTLET SHUTTLE DISKS	418
MOISTURE INDICATORS	416
MOUNTING BRACKETS	407-412
OIL & COLLECTION CONTAINERS	429 & 430
OUTLET & INLET SHUTTLE DISKS (See Inlet & Outlet Shuttle Disks)	
PARTICLE FILTER ASSEMBLIES & REPLACEMENT PARTS	410
PARTICULATE FILTER ASSEMBLY & REPLACEMENT PARTS	411
POWER SWITCHES & CIRCUIT BREAKERS	431
PRESSURE GAUGES	434
PRESSURE RELIEF VALVES	433 & 434
PRESSURE SWITCHES & VALVES	433 & 434
RELAYS	432
SAFETY VALVES	435
SIGHT GLASSES & SIGHT GLASS TOOL	435
SOLENOID VALVES & REPAIR KITS	436-438
START BOXES	439
START & RUN CAPACITORS (See Capacitors)	
THERMAL PROTECTOR ASSEMBLIES	440
TOOLS & ACCESSORIES	413, 416, 430, 435 & 441
TOOLS - GREASE GUN & ACCESSORIES FOR SCROLL COMPRESSORS	441
TRANSFORMERS	432
TUBING & ACCESSORIES	442
UNLOADER VALVES	443

DENTAL DELIVERY SYSTEMS/UNITS

A-DEC

INDEX TO PARTS BY COMPONENT OR TYPE OF PART

BARBS & BARB KITS	516 & 517
CARTRIDGES, PISTONS, POPPETS & STEMS	519-521
CABLE MANAGEMENT (Refer to General Shop Aids, Section 6)	
CLAMPS	516 & 517
CONTROL HEAD COMPONENTS	507 & 508
COOLANT CONTROL COMPONENT PARTS, KITS & EXPLODED VIEW	511
- Coolant Air Valve (22-0940-00)	511
- Coolant Water Valve (22-0960-00 & 22-0790-00)	511
- Water Coolant Relay Assembly 500 Series (38.1810.00)	511
DIAPHRAGMS	518
FILTERS	510
- Air Filter Regulator (026-021-01)	510
- Filter/Moisture Separator (026-066-00)	510
- Filter Regulators (24-0168-00, 24-0170-00 & 24-0175-00)	510
- In Line Filter Assembly (19-0100-00)	510
- Utility Module (24-0352-00)	510
- Water Filter Regulator (40-0654-00)	510

(continued)

Dental Equipment

OEM MODEL Section 4 Page #'s

DENTAL DELIVERY SYSTEMS/UNITS (continued)

A-DEC (continued)

INDEX TO PARTS BY COMPONENT OR TYPE OF PART

FOOT CONTROL KITS, PARTS & EXPLODED VIEWS . . . 513-515

- Foot Control Accessory Button (38.0612.00) 508
- Foot Control 300 Series (38.1821.00) 513-515
- Foot Control 500 Series (38.1805.00) 513-515
- Foot Control (38-0050-00) 513-515
- Foot Control II (38-0254-00) 513-515
- Foot Control III (38.1601.00, 38.1603.00 & 38.1700.00) 513-515
- Foot Control Lever Action (38-0200-00) 513-515

GASKETS 518

HANDPIECE CONTROL BLOCKS, PARTS, KITS & EXPLODED VIEWS 500-507

- Handpiece Control Block 300 Series (38.1831.00) 501 & 502
- Handpiece Control Block 500 Series (38.1776.00) 500-502
- Handpiece Control Block Century Plus (38.0540.00) 503-505
- Handpiece Control Block Century II (38.0223.00) 506 & 507
- Handpiece Control Block Century Water Valve Assembly (38.0098.00) 507

KNOBS 507

O-RING, O-RING KITS, TOOLS & LUBRICANT 522-524

PISTONS, POPPETS, STEMS & CARTRIDGES 519-521

POPPETS, PISTONS, STEMS & CARTRIDGES 519-521

RETAINING SPRINGS & RINGS 529

REGULATOR KITS & PARTS 512

- Air and Water Filter Regulator (40-0654-00) 512
- Air and Water Shut-Off Valve (Air Operated) (30-0330-00) 512
- Air Filter Regulator (026-021-01) 510 & 512
- Air Regulator Valve "White Bodies" (24-0135-00) 509
- Filter Regulators (24-0168-00, 24-0170-00 & 24-0175-00) 509 & 510
- Water Filter Regulator (40-0654-00) 510 & 512
- Water Regulator Valve "Black Bodies" (24-0355-00) 509

SALIVA EJECTOR TIPS 527

SCREWS & KIT 525 & 526

SLEEVES 516 & 517

SLEEVE TOOLS (Sizes: 1/8", 1/4" & Universal) 516

SPRINGS 528

STRAIGHT PINS (For Valves, Valve Assemblies & Syringes) 508

STEMS, PISTONS, POPPETS & CARTRIDGES 519-521

SYRINGE PARTS 529

TOGGLE VALVES 508

- Cup Fill & 2 Way Momentary Toggle Valves 508
- Wet/Dry Toggle Valve (38.0604.00) 508

TOGGLE VALVE SWITCH 508

TOOLS (Including "Plastic & Metal Tubing Snakes") (Refer to General Shop Aids, Section 6)

TUBING MANAGEMENT (Refer to General Shop Aids, Section 6)

UTILITY MODULE KITS, PARTS & EXPLODED VIEW 509 & 510

- Utility Module (24-0352-00) 509 & 510

VACUUM SYSTEMS PARTS & KIT 527

- Vacuum Drain Actuator (40-0742-00) 527
- Vacuum Sink Assembly (55-0200-00) 527

VALVE CORE REMOVAL/SYRINGE TOOL 529

VALVES - CHECK VALVE & MICRO VALVE 508

WASHERS 517

(continued)

OEM MODEL Section 4 Page #'s

DENTAL DELIVERY SYSTEMS/UNITS (continued)

PELTON & CRANE

Spirit® 550-553

Spirit® II 550-553

Spirit® IIE 550-553

Spirit® AC 551-553

Spirit® EC 550-553

DENTAL EQUIPMENT TOOLS

DENTAL TOOLS

Dental Tools 1500

DENTAL FILM PROCESSORS

AIR TECHNIQUES

A/T2000 600 & 601

A/T2000 Plus 600 & 601

A/T2000 XR 600 & 601

Peri Pro I® (90000) 602-608

Peri Pro II® (91000) 602-608

Peri Pro III® (94000) 602-608

DENT-X (Phillips)

810 & 9000 Developer Transport Module 700-702

810 & 9000 Fixer Transport Module 700-702

810 & 9000 Washer/Dryer Transport Module 700-702

GENDEX

GXP™ 850-853

LITTON

P4 800

P6 800

P10 800

DENTAL LABORATORY EQUIPMENT

NEY (Porcelain Ovens)

650 900 & 901

660 900 & 901

Mark II 900 & 901

Mark III 900 & 901

Mark IV 900 & 901

RAY FOSTER

10" & 12" Trimmer 903

(continued)

OEM MODEL Section 4 Page #'s

DENTAL LABORATORY EQUIPMENT *(continued)*

WELLS (Engine units: U900, U901, U903 & U904)

Arms: AS011 (Piccolo Engine Arm)	902
Arms: AS012 (Standard Engine Arm)	902
Arms: AS051 (Whisper Short Arm)	902
Arms: (Whisper Long Arm)	902
Foot Controls: F011 & F013	902
Hood & Motor: E026, E027, E028 & E029	902
Motor: Baldor - E132 & E133	902
Motor: Bodine (Large Brush) - E-131	902
Motor: Bodine (Small Brush) - E-129 & E-130	902
Motor: WSM	902

WHIP MIX

Vac-U-Vester	903
--------------------	-----

DENTAL LAMPS & BULBS

DENTAL LAMPS & BULBS

Various OEMs and Models	1000
-------------------------------	------

DENTAL LIGHTS

A-DEC

6300 Series	1100 & 1101
Performer	1101

BELMONT & HEALTHCO

Belmont Clesta 501	1205
Belmont Clesta 502	1205
Belmont Clesta 505	1205
Belmont X-Calibur	1202-1204
Healthco X-Calibur	1202-1204

CASTLE

Accuvision	1201
Panavision	1201

KNIGHT by Midmark®

"L" Operating Light	1200
"K" Super Starlite	1200

MARUS

Luxstar	1200
CL1000	1200
UL1000	1200
TL1000	1200

PELTON & CRANE

LF Series	1300-1303
LF+ Series	1300-1303
LFII Series	1304-1311
LFIII Series	1304-1311

RITTER

"J" Starlite	1200
"K" Super Starlite	1200

(continued)

OEM MODEL Section 4 Page #'s

DENTAL LIGHTS *(continued)*

HENRY SCHEIN® DENTAL

Crusader Style, Starbrite 800-1	1200
Crusader Style, Starbrite 800-3	1200
Crusader Style, Starbrite 800-5	1200
Crusader Style, Starbrite 800-7	1200

DENTAL MOTORS

EMESCO

"N" Series	1400
------------------	------

RITTER

C & D	1400
E, F & J	1400

WELLS

All Models	1400
------------------	------

DENTAL ULTRASONIC CLEANERS

L&R

L&R	1550 & 1551
-----------	-------------

NEY (DENTSPLY)

Ney (Dentsply)	1550 & 1551
----------------------	-------------

PATTERSON DENTAL

Patterson Dental	1550 & 1551
------------------------	-------------

HENRY SCHEIN® DENTAL

Henry Schein Dental	1550 & 1551
---------------------------	-------------

DENTAL ULTRASONIC SCALERS

DENTSPLY

Cavitron® BOBCAT® 25 KHz - G115	1600-1609
Cavitron® BOBCAT® Pro - G130	1600-1609
Cavitron® DualSelect™ Dispensing System - G118	1600-1609
Cavitron® JET Plus™ - G132	1600-1609
Cavitron® JET Plus™ - G137	1600-1609
Cavitron® JET with SPS™ - G120	1600-1609
Cavitron® Plus™ Scaler - G131	1600-1609
Cavitron® Plus™ Scaler - G136	1600-1609
Cavitron® Prophy-JET® Air Polishing System - G122	1600-1609
Cavitron® Prophy-JET - G138	1600-1609
Cavitron® Select™ Scaler 25K - G121	1600-1609
Cavitron® Select™ SPS™ 30K - G124	1600-1609
Cavitron® SPS™ Surface Mount Ultrasonic Scaler - G98a	1600-1609
Cavitron® SPS™ Ultrasonic Scaler - G119	1600-1609
Cavitron® Touch™ Scaler - G1000	1600-1609

(continued)

Dental Equipment

OEM MODEL Section 4 Page #'s

DENTAL VACUUM UNITS

AIR TECHNIQUES, APOLLO/MIDMARK®, DENTALEZ®/CUSTOM AIR/RAMVAC, MATRX/MIDMARK®, MIDMARK®, TECH WEST & VADA TRAPS

INDEX TO PARTS BY COMPONENT OR TYPE OF PART

ANTI-SYPHON VALVES & REPAIR KITS	1707
BRUSH KIT	1712
CAPACITORS	1717
CHECK VALVES & REPAIR KITS	1704 & 1710
CIRCUIT BREAKERS	1718
CUSPIDOR DRAIN VALVE (VADA TRAP) & BOWL KITS ...	1701
DIAPHRAGMS	1701
DRAIN ASSEMBLY	1715
DRIVE BELTS & BELT TENSIONER TESTER	1711
FAN	1716
FILTER ELEMENTS, SCREENS & ASSEMBLIES 1703, 1713 & 1715	
FLOAT ASSEMBLIES	1714
FLOAT SWITCHES	1715
FLOW REGULATORS	1708
FUSES & FUSE HOLDERS	1720
GASKETS (CAS COVER, FLANGE & SEPARATOR LID) ...	1714
HARDWARE: FLAG TERMINAL	1709
HOUR METER	1716
LIMIT SWITCH	1719
MANIFOLD GASKETS	1704
PILOT LIGHT	1716
PLUMBING: ACCESSORIES	1709
PLUMBING: FITTINGS & POLYFLO NUT	1709
POWER SWITCHES	1718 & 1719
PUMP REPAIR KIT	1712
RELAYS & RELAY SOCKET	1721
SINK DRAIN VALVE	1701
SOLENOID VALVE ASSEMBLIES & REPAIR KITS ...	1706 & 1707
SOLIDS COLLECTORS, BOWL KITS & SCREENS	1700 & 1710
SOLIDS COLLECTORS REPLACEMENT KITS	1700 & 1710
STRAINERS (WATER) & STRAINER ELEMENTS	1705
SWITCHES (SOLID STATE)	1719
SYNTHETIC OIL	1712
TANK WASHOUT KIT & TUBING	1712
THERMAL OVERLOAD SWITCHES	1719
THERMOSTAT	1716
TRANSFORMERS	1716
VACUUM GAUGES	1702
VACUUM RELIEF VALVES & REPAIR KITS	1703 & 1715
VALVE (SHUT OFF)	1708
WATER CONTROL ASSEMBLIES	1705

DENTAL X-RAY UNITS

GENDEX

765 DC Intraoral X-Ray	1800
GX-770™ Intraoral X-Ray	1800
Orthoralix® 9000 Panoramic X-Ray	1800

Models: Cascade 1040; Decade 1010, 1011, 1015, 1020 & 1021; Performer I, II & III; Positioner 1030; and Priority 1005

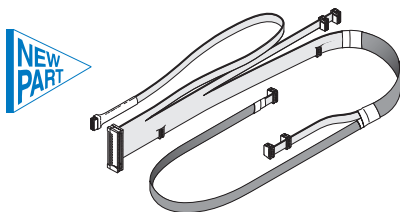

RPI Part #ADC204
OEM Part #61.0612.00

CABLE ASSY (MAIN)
• Overall length: ~46"
Fits: Connects Chair Top, Chair Seat & Chair Base Assemblies
Model: Priority 1005 (Serial #M1-0001 thru D3-0134)

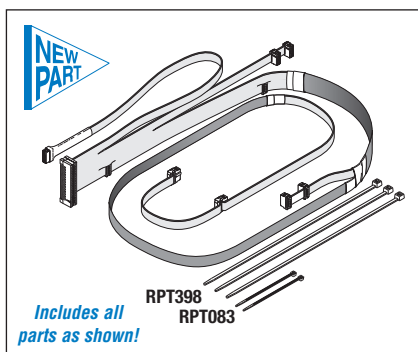

RPI Part #ADC207
OEM Part #61.0599.00

CABLE ASSY (MAIN)
• Overall length: ~68"
Fits: Connects Chair Top, Chair Seat & Chair Base Assemblies
Model: Priority 1005 (Serial #D3-0135 thru H3-0067)

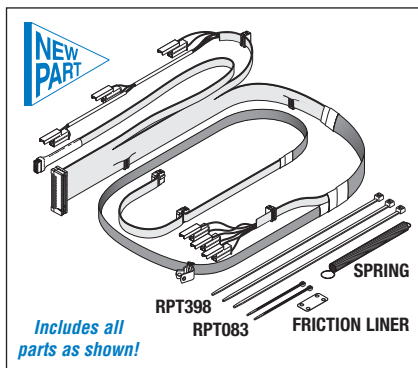

RPI Part #ADK208
OEM Part #61.0668.00

CABLE ASSY (MAIN COMPLETE)
• Overall length: ~70.50"
• Also available Switch Assembly (Tilt Limit) (RPI Part #ADA228)
Fits: Connects Chair Top, Chair Seat & Chair Base Assemblies
Model: Priority 1005 (Serial #H3-0068 thru present)

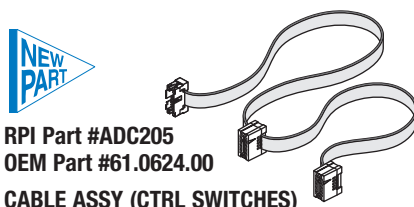

RPI Part #ADC205
OEM Part #61.0624.00

CABLE ASSY (CTRL SWITCHES)
• Overall length: ~24"
Fits: Chair Back Assembly
Model: Priority 1005 (Serial #M1-0001 thru D3-0134)

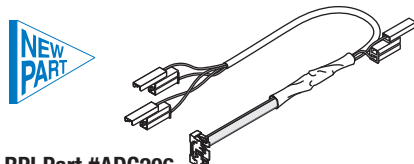

RPI Part #ADC206
OEM Part #61.0613.00

CABLE ASSY (LIFT LIMIT)
• Overall length: ~18.25"
Fits: Base Assembly
Model: Priority 1005 (Serial #M1-0001 thru H3-0067)

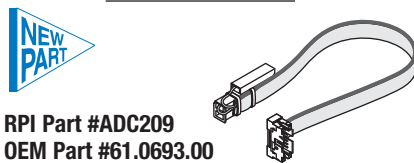

RPI Part #ADC209
OEM Part #61.0693.00

CABLE (PRE-POSITION BASE)
• Overall length: ~12.50"
Fits: Connects the Main Cable to Lift Pre-Position Assembly (OEM Part #61.0593.00)
Model: Priority 1005 (Serial #H3-0068 thru present)

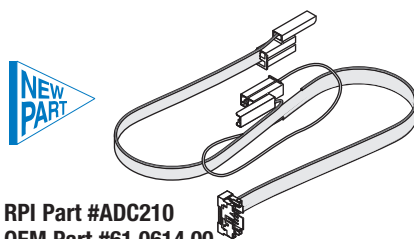

RPI Part #ADC210
OEM Part #61.0614.00

CABLE ASSY (STOP PLATE)
• Overall length: ~23.50"
Fits: Base Assembly
Model: Priority 1005 (Serial #M1-0001 thru present)

RPI Part #RPT398
OEM Part # (No OEM Part # Available)

CABLE TIE (12" GRAY)
• 25 per package
Models: Cascade 1040; Decade 1010, 1011, 1015, 1020 & 1021; Performer I, II & III; Positioner 1030 and Priority 1005

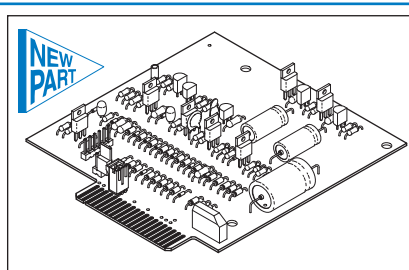
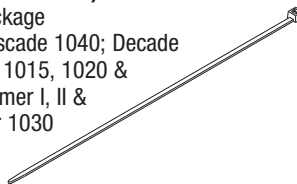

RPI Part #ADB203
OEM Part #61.0688.00, 61-0833-00 & 61-0616-00

CIRCUIT BOARD ('A' BOX)
• RPI added jumper system for LK 1 to disable the pre-position functions
Fits: "A" Box
Model: Priority 1005 (Serial #M1-0001 thru present)

RPI ADVANTAGE!

Header System is added to the test points for easy testing of chair functions.

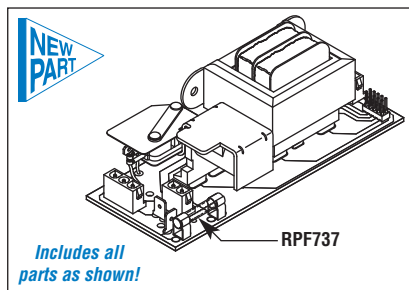

RPI Part #ADB219
OEM Part #61.0645.00

CIRCUIT BOARD ('B' BOX)
• 100/120 VAC
Fits: "B" Box
Model: Priority 1005 (Serial #M1-0001 thru present)



RPI Part #RPF737
OEM Part #046-070-00

FUSE (0.6A, 250V) - 5/pkg
• Type: Glass; 3AG Time Delay
• Size: 1/4" dia. x 1-1/4" lg
Fits: Circuit Board "B" Box
Model: Priority 1005 (Serial #M1-0001 thru present)



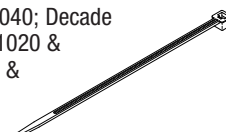

RPI Part #RPT083
OEM Part # (No OEM Part # Available)



CABLE TIE (4" WHITE)
• 25 per package
Models: Cascade 1040; Decade 1010, 1011, 1015, 1020 & 1021; Performer I, II & III; Positioner 1030 and Priority 1005

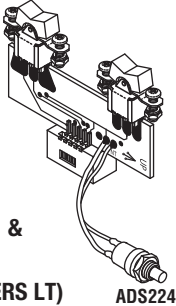

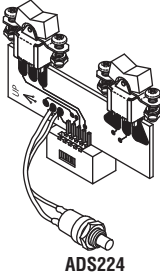
Dental Equipment

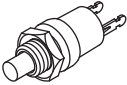
Models: Cascade 1040; Decade 1010, 1011, 1015, 1020 & 1021; Performer I, II & III; Positioner 1030; and Priority 1005

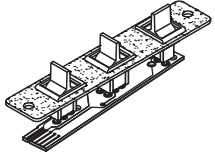
  <p><i>Includes all parts as shown and mounting hardware</i></p> <p>RPI Part #ADA216 OEM Part #61.0661.01 & 61.0656.01</p> <p>SWITCH ASSY (ROCKERS LT)</p> <ul style="list-style-type: none"> • Pre-position (left side only) • White rocker switches <p>Fits: Backrest Assembly (left side only) Model: Priority 1005 (Serial #D3-0135 thru present)</p>	  <p><i>Includes all parts as shown and mounting hardware</i></p> <p>RPI Part #ADA215 OEM Part #61.0661.00 & 61.0656.00</p> <p>SWITCH ASSY (ROCKERS RT)</p> <ul style="list-style-type: none"> • Auto return (right side only) • White rocker switches <p>Fits: Backrest Assembly (right side only) Model: Priority 1005 (Serial #D3-0135 thru present)</p>	  <p>RPI Part #ADS224 OEM Part #041.059.00</p> <p>SWITCH (PUSH-BUTTON)</p> <ul style="list-style-type: none"> • 5A @ 120VAC, 2.5A @ 220VAC • SPST; Momentary; N.O. • Black button <p>Fits: 8 Function Footswitch, Multi-Function Footswitch, Auto Return and Pre-position Assemblies Models: Cascade 1040; Decade 1021; Priority 1005 (Serial #D3-0135 thru present)</p>
--	--	---

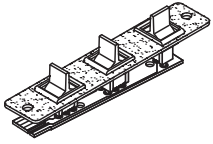
  <p>RPI Part #ADA213 OEM Part #61.0625.00</p> <p>SWITCH ASSY (PADDLES LT)</p> <ul style="list-style-type: none"> • Left side only, pre-position • 3 black paddle switches <p>Fits: Backrest Assembly (left side only) Model: Priority 1005 (Serial #M1-0001 thru D3-0134)</p>	  <p>RPI Part #ADA214 OEM Part #61.0626.00</p> <p>SWITCH ASSY (PADDLES RT)</p> <ul style="list-style-type: none"> • Right side only, auto return • 3 black paddle switches <p>Fits: Backrest Assembly (right side only) Model: Priority 1005 (Serial #M1-0001 thru D3-0134)</p>
--	--

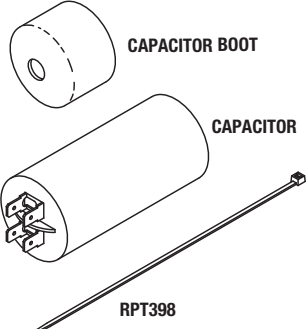

RPI Part #ADK221
OEM Part #041.164.00 & 90.1031.00



CAPACITOR KIT

- 50uf, 280VAC, 50/60Hz
- Size: 1.81" dia x 3.35" tall
- Dual .25" tabs
- For 100VAC, 115VAC, and for 240VAC chairs built before February 13, 2001

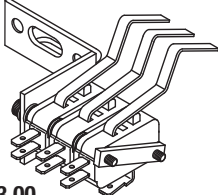
Fits: "B" Box
Models: Cascade 1040; Decade 1010, 1011, 1015, 1020 & 1021; Performer III; Positioner 1030; Priority 1005 (Serial #M1-0001 thru present)

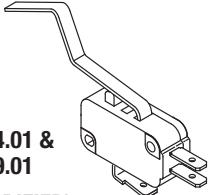
Includes all parts as shown!

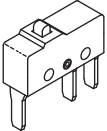
  <p>RPI Part #ADA228 OEM Part #61.0453.00</p> <p>SWITCH ASSY (TILT LIMIT)</p> <ul style="list-style-type: none"> • Includes: (3) Limit Switch (Modified) (RPI Part #ADS211) <p>Fits: Chair Seat Assembly Model: Priority 1005 (Serial #H3-0068 thru present)</p>	  <p>RPI Part #ADS211 OEM Part #044.184.01 & 044.049.01</p> <p>LIMIT SWITCH (MODIFIED)</p> <ul style="list-style-type: none"> • 15.1A @ 125/250 VAC • SPDT; .187" tabs <p>Fits: Various positions and chairs Models: Cascade 1040; Decade 1010, 1011, 1020 & 1021; Performer III; Positioner 1030; Priority 1005</p>
--	--

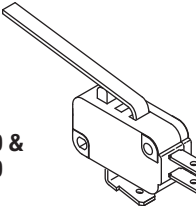
  <p>RPI Part #ADS223 OEM Part #041.119.00</p> <p>SWITCH (MINIATURE)</p> <ul style="list-style-type: none"> • 10.1A @ 125/250VAC <p>Fits: 8 Function Footswitch (OEM Part #61.3043.80) 100VAC/120VAC & 240VAC Model: Priority 1005 (Serial #M1-0001 thru present)</p>	  <p>RPI Part #ADS212 OEM Part #044.184.00 & 044.049.00</p> <p>MICRO-SWITCH</p> <ul style="list-style-type: none"> • 15.1A @ 125/250 VAC • SPDT; .187" tabs <p>Fits: Various positions and chairs Models: Decade 1010, 1011, 1020 & 1021; Performer I, II & III</p>
--	--

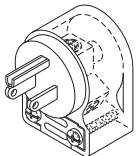

RPI Part #RPP032
OEM Part # (No OEM Part # Available)

HOSPITAL GRADE MALE PLUG (RIGHT ANGLE)

- Made by Hubbell®
- 15A@125VAC
- Accepts 0.255" dia. to 0.665" dia. Cord
- NEMA 5-15P
- Transparent housing

Models: Cascade 1040; Decade 1010, 1011, 1015, 1020 & 1021; Performer I, II & III; Positioner 1030 and Priority 1005

Models: Cascade 1040; Decade 1010, 1011, 1015, 1020 & 1021; Performer I, II & III; Positioner 1030; and Priority 1005

RPI Part #RP0316
OEM Part #030-015-02

- O-RING - (12/PKG)**
- Material: Buna N; Duro: 70
 - Size: .551" ID x .691" OD x .070" C/S
- Fits:** Manifold Assembly
Model: Priority 1005
(Serial #M1-0001 thru L3-0200)

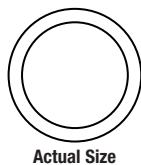

RPI Part #RP0738
OEM Part #35.041.02

- O-RING - (10/PKG)**
- Material: Buna N; Duro: 70
 - Size: .614" ID x .768" OD x .077" C/S
- Fits:** Solenoid Valve - Old Style Hydraulic Manifold O-ring Pocket with or without an ID mark/dot
Model: Priority 1005
(Serial #M1-0001 thru L3-0200)

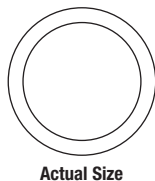

RPI Part #RPT017
OEM Part # (No OEM Part # Available)

- WIRE NUT - (25/PKG)**
- #22-16 AWG; Insulated; Grey
- Models:** Cascade 1040; Decade 1010, 1011, 1015, 1020 & 1021; Performer I, II & III; Positioner 1030 and Priority 1005

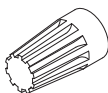

RPI Part #RPT083
OEM Part # (No OEM Part # Available)

- CABLE TIE (4" WHITE) - (25/PKG)**
- Models:** Cascade 1040; Decade 1010, 1011, 1015, 1020 & 1021; Performer I, II & III; Positioner 1030 and Priority 1005



RPI Part #ADW038
OEM Part #004-005-00

- FLAT WASHER - (50/PKG)**
- Fits:** Reservoir
- Models:** Cascade 1040; Decade 1010, 1011, 1015, 1020 & 1021; Performer I, II & III; Positioner 1030 and Priority 1005



RPI Part #ADB011
OEM Part #023-001-01

- BARB - (10/PKG)**
- Fits:** Reservoir
- Models:** Cascade 1040; Decade 1010, 1011, 1015, 1020 & 1021; Performer I, II & III; Positioner 1030 and Priority 1005

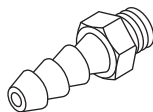

Includes all parts as shown!

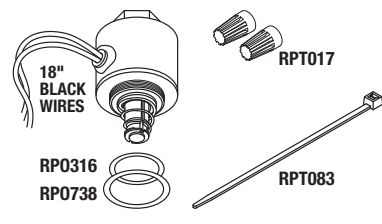

RPI Part #ADK220
OEM Part #60.0601.00

- SOLENOID VALVE REPAIR KIT**
- 24 VDC; 7.4 W; Coil ~78 Ω
- Fits:** Manifold Assembly
Model: Priority 1005
(Serial #M1-0001 thru L3-0200)

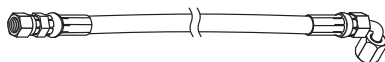

RPI Part #ADH217
OEM Part #61.0217.01

- HOSE ASSY (TILT CYLINDER)**
- Length: ~44.00"
 - Fittings: 7/16-20 Flare Female x 7/16-20 Flare 90° Elbow
- Fits:** Tilt Cylinder
Model: Priority 1005 (Serial #M1-0001 thru present)

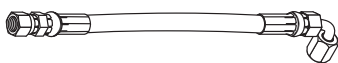

RPI Part #ADH218
OEM Part #61.0218.01

- HOSE ASSY (LIFT CYLINDER)**
- Length: ~10.00"
 - Fittings: 7/16-20 Flare Female x 7/16-20 Flare 90° Elbow
- Fits:** Lift Cylinder
Model: Priority 1005 (Serial #M1-0001 thru present)



Also available by the case (12 bottles) (RPI Part #RPF453)

RPI Part #RPF449
OEM Part #61-0197-00

- HYDRAULIC FLUID**
- 16 fluid ounces
 - Includes Yorker Cap
 - Shell Tellus T46 Oil (ISO 46)
- For:** Pump Reservoir
Models: Cascade 1040; Decade 1010, 1011, 1015, 1020 & 1021; Performer I, II & III; Positioner 1030 and Priority 1005

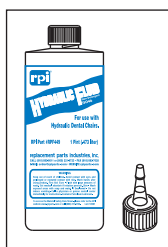

Includes all parts as shown!

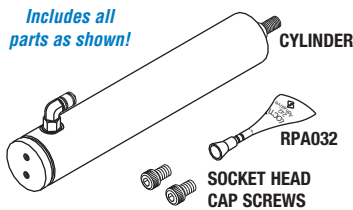

RPI Part #ADC174
OEM Part #61-0860-00

- TILT CYLINDER KIT**
- Fits:** Link Assembly
Model: Priority 1005

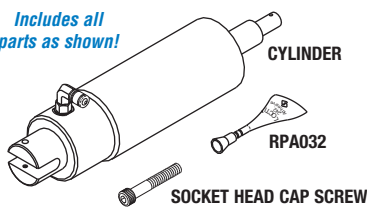

RPI Part #ADC175
OEM Part #61-0850-00

- LIFT CYLINDER KIT**
- Fits:** Between baseplate and upper structure of chair
Model: Priority 1005

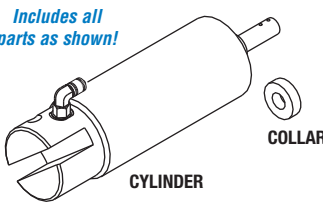

RPI Part #ADC176
OEM Part #61-1287-00

- LIFT CYLINDER KIT**
- Fits:** Between baseplate and upper structure of chair
Models: Cascade 1040; Decade 1010, 1011, 1015, 1020 & 1021; and Performer III

RPI Part #ADC177
OEM Part #61-2050-00

- TILT CYLINDER**
- Fits:** Link Assembly
Model: Cascade 1040

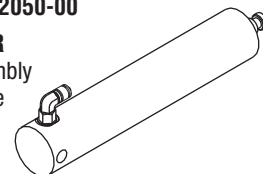

RPI Part #ADC178
OEM Part #61-1267-00

- TILT CYLINDER**
- Fits:** Link Assembly
Models: Decade 1010, 1011, 1015, 1020 & 1021

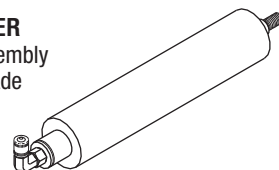

Dental Equipment

Models: Cascade 1040; Decade 1010, 1011, 1015, 1020 & 1021; Performer I, II & III; Positioner 1030; and Priority 1005

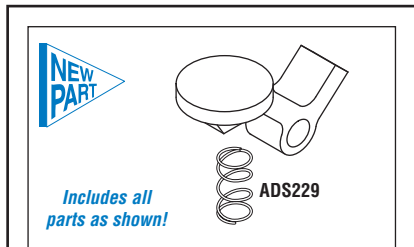

RPI Part #ADK222
OEM Part #61.0030.00 (Latch) & 013-017-00 (Compression Spring)

LATCH KIT (ARMREST)

- Material: Nickel plated aluminium
- Fits:** Armrest Assembly
- Model:** Priority 1005 (Serial #M1-0001 thru present)



RPI Part #ADS229
OEM Part #013-017-00

COMPRESSION SPRING - (10/PKG)

- Material: Stainless steel
- .243" OD x .500" lg x .022" dia wire
- Fits:** Latch Kit (Armrest)
- Model:** Priority 1005 (Serial #M1-0001 thru present)

RPI Part #RPT295
OEM Part # (No OEM Part # Available)

1/4" SLEEVE TOOL

- Use on 1/4" OD tubing; ~5" lg.
- The tool provides 90° and 45° angles for ease of use

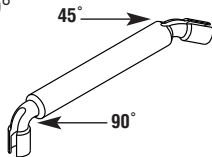

RPI Part #RPT296
OEM Part # (No OEM Part # Available)

UNIVERSAL SLEEVE TOOL

- Use on 1/4" OD and 1/8" OD tubing; ~5" lg.
- The tool provides 90° angles on both ends for ease of use

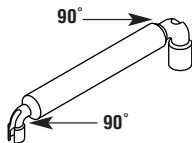

RPI Part #ADC035
OEM Part #025-015-01

SLEEVE CLAMP - (20/PKG)

- Material: Polyurethane
- Fits: 1/4" OD tubing with 1/8" barb
- Also included in: Barb Kit (RPI Part #ADK080)

Models: Cascade 1040; Decade 1010, 1011, 1015, 1020 & 1021; Performer I, II & III; Positioner 1030 and Priority 1005

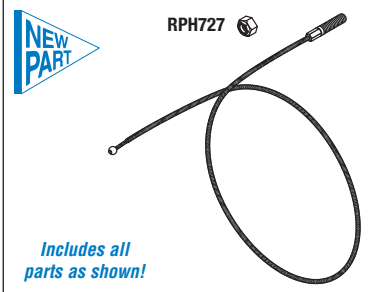
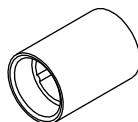

RPI Part #ADC226
OEM Part #61.0025.00 (Cable) & 006.023.00 (Nut)

BRAKE CABLE

- ~25.31" Long; Clear Nylon® Jacket
- Stainless steel cable and fittings
- Fits:** Swivel and Brake Assembly
- Model:** Priority 1005 (Serial #M1-0001 thru H3-0067)

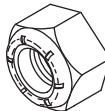

RPI Part #RPH727
OEM Part #006.023.00

HEX NUT (1/4-20)

- 10 per package
- Stainless Steel with Nylon® Insert
- Fits:** Brake Cable Assembly
- Model:** Priority 1005 (Serial #M1-0001 thru H3-0067)

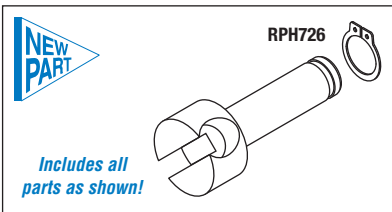

RPI Part #ADM225
OEM Part #61.0081.00 (Mount) & 010.028.00 (Retaining Ring)

MOUNT (BRAKE CABLE)

- Material: Nickel plated steel
- Fits:** Swivel and Brake Assembly
- Model:** Priority 1005 (Serial #M1-0001 thru H3-0067)

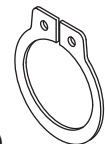

RPI Part #RPH726
OEM Part #010.028.00

RETAINING RING (EXTERNAL)

- 10 per package
- Material: Stainless steel
- For .281" OD shaft
- Fits:** Brake Mount

Model: Priority 1005 (Serial #M1-0001 thru H3-0067)

Articulating Headrest Parts (Misc)

RPI Part #ADS045
OEM Part #013-022-00

SPRING - (10/PKG)
Fits: Articulating Headrest



RPI Part #ADS062
OEM Part #19-0230-00

SPRING - (10/PKG)
Fits: Articulating Headrest

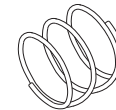

RPI Part #RPO316
OEM Part #003-015-00

O-RING - (12/PKG)
Fits: Articulating Headrest



Manifold Parts (Misc)

RPI Part #ADS169
OEM Part #002-118-00

BUTTON HEAD CAP SCREW - (5/PKG)
Fits: All one piece hydraulic Manifolds

Flow Adjustment
Models: Cascade, Decade, Performer, Positioner 1030 and Priority 1005



RPI Part #ADS052
OEM Part #001-002-00

TRUSS HEAD SLOTTED SCREW - (10/PKG)
Fits: All two piece hydraulic Manifold

Flow Adjustment
Models: Cascade, Decade, Performer, Positioner 1030 and Priority 1005



RPI Part #RPO312
OEM Part #030-004-00

O-RING - (12/PKG)
Fits: Manifold Flow Adjustment (see Footnotes 1 & 2 below) and Check Valve Stem (see Footnote 2 below)



RPI Part #RPO305
OEM Part #030-010-00

O-RING - (12/PKG)
Fits: Manifold Block Separators (see Footnotes 1 & 2 below)



RPI Part #RPO303
OEM Part #030-012-00

O-RING - (12/PKG)
Fits: Manifold Check Valve Tube Fitting (see Footnotes 1 & 2 below) and Elbow Flare Fitting (see Footnote 2 below)

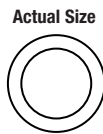

RPI Part #RPO317
OEM Part #030-016-00

O-RING - (12/PKG)
Fits: Manifold Pressure Relief Valve (see Footnote 1 below)



MANIFOLD O-RING FOOTNOTES

- (1) Fits Priority 1005 (Serial # M1-0001 thru L3-0200)
- (2) Fits Priority 1005 (Serial # L3-0201 thru present)

RPI Part #DEA603
OEM Part # (None)

ACTUATOR

- White plastic with brass insert
 - 1/4-40 right hand thread
- Fits:** Chair Back Motor
(OEM Part 3574-082)
Models: E-1, JS & VS

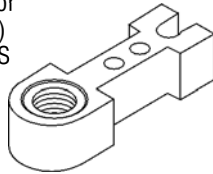

RPI Part #DEA612
OEM Part # (None)

ACTUATOR

- Blue plastic with brass insert
 - 1/4-28 left hand thread
- Fits:** Chair Back Motor
(OEM Part #3574-046,
3574-107, 3574-033 & DZ1)
Models: JS & VS

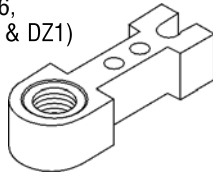

RPI Part #DEA613
OEM Part # (None)

ACTUATOR

- Red plastic with brass insert
 - 1/4-28 right hand thread
- Fits:** Chair Seat Motor
(OEM Part #3574-044 & 3574-026)
Models: JS & VS

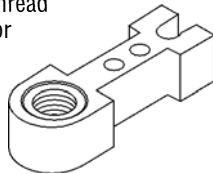

RPI Part #DEA614
OEM Part # (None)

ACTUATOR

- Black plastic with brass insert
 - 1/4-64 left hand thread
- Fits:** Base Motor
(OEM Part #3574-21)
Models: PL-200,
PLA-200 & Elegan

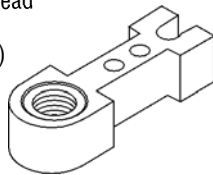

RPI Part #DEC610
OEM Part #3800-067

CAPACITOR

- 115 V, 53-64 MFD, 330 VAC
- Fits:** Base Motor
Models: PL-200,
PLA200 & Elegan

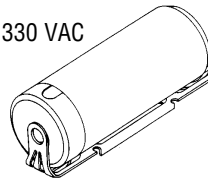

RPI Part #DEG601
OEM Part #3800-151

SEAT TILT MOTOR GEAR

- White plastic with steel insert
 - 30 teeth
- Fits:** Seat Tilt Motor
Models: JS, VS,
PL-100 & PLA200
D-12 Motor

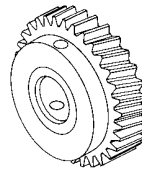

RPI Part #DEG602
OEM Part #3800-150

BACK MOTOR GEAR

- White plastic with steel inserts
 - 29 teeth
- Fits:** Back Motor
Models: JS, JSA,
PLA200 & VS

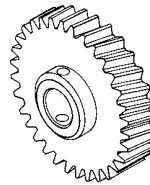

RPI Part #DES605
OEM Part #3800-100

MOMENTARY SWITCH

- Momentary ON/OFF/Momentary ON
 - Long narrow smooth white rocker
 - 6 A @ 125 VAC; 3 A @ 250 VAC;
 - 1/4 HP, 125-250 VAC
- Fits:** Chair Back
Models: JS, JSA & VS

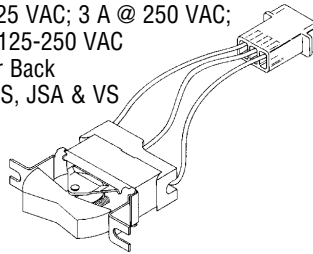

RPI Part #DES606
OEM Part #3800-101

AUTO POSITION SWITCH

- Momentary ON/OFF/Momentary ON
 - Long narrow cross serrated white rocker
 - 6 A @ 125 VAC; 3 A @ 250 VAC;
 - 1/4 HP, 125-250 VAC
- Fits:** Chair Back
Models: JS & VS

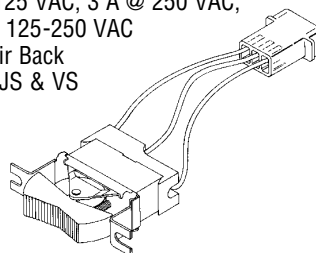

RPI Part #DES607
OEM Part #3800-148

ON/OFF/ON SWITCH

- ON/OFF/ON
 - Long narrow smooth white rocker
 - 6 A @ 125 VAC; 3 A @ 250 VAC;
 - 1/4 HP, 125-250 VAC
- Fits:** Chair Back
Models: JS & VS

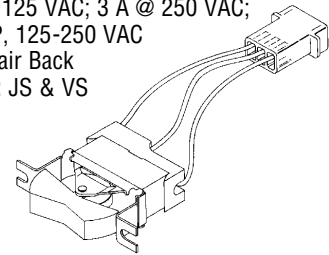

RPI Part #DES608
OEM Part #3800-006

MOTOR LIMIT SWITCH

- 2 per package
 - Normally Closed
 - 10 A, 1/2 HP @ 125/250 VAC
- Fits:** Base, Seat Tilt and Back Motor
Models: JS & VS

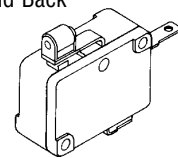

RPI Part #DES609
OEM Part #3800-155

ROCKER SWITCH

- Momentary ON/OFF/Momentary ON
 - 5/8" cross serrated black rocker
 - 6 A @ 25 VAC;
 - 3 A @ 250 VAC;
 - 1/4 HP, 125-250VAC
- Fits:** Chair Back
Models: JS & VS

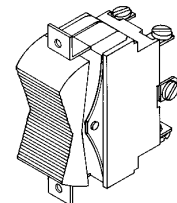

RPI Part #DES611
OEM Part #3800-112

ARM SCREW

- 2 per package
 - 5/16-24 x .860" long
 - Stainless steel
- Fits:** Control Sleeve
Models: JS & VS

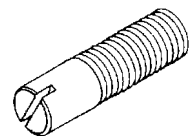

Service Tip

The actuators, gears, and motor limit switches also fit Gearmaster® motors. Gearmaster motors are used in other dental chairs and industrial equipment.

*Gearmaster is a registered trademark of Emerson Electric, Co.

You can depend on RPI for quality parts. We guarantee it!

RPI Part #RCA061
OEM Part #144648

METERING SCREW ASSEMBLY

- Brass
- Includes metering screw with O-rings (RPI Part #RPO306 & RPO307)
- Fits:** Solenoid Valve
- Model:** FL **Type:** 75, 75-C, 7-F & All models using old style Solenoid Coil



New RPI Part #RPO307
Old RPI Part #RC0040
OEM Part #P-12233 & 146180
Industry Part #2-006

O-RING

- 12 per package
- Material: Buna-N
- Hardness: 70 Duro
- .1/4" OD x .1/8" ID x 1/16" C/S
- Fits:** Solenoid Metering Screw
- Model:** FL **Type:** 75, 75-C & 7-F



RPI Part #RCC062
OEM Part #171421

MOTOR STARTING CAPACITOR

- 108–130 MFD, 110–125VAC, 60 Hz.
- Fits:** Motor
- Model:** FL **Type:** 75, 75-C & 7-F

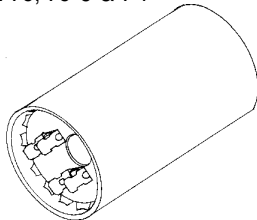

RPI Part #RCC601
OEM Part #14183

SOLENOID COIL

- 49.78 Ω min; 55.02 Ω max; Coil Rating: 120VAC
- Coil: 1.265" OD x 1.335" long with .50" diameter through hole
- Wire: 11" long
- Fits:** Solenoid Valve
- Model:** FL **Type:** 75, 75-C, 7-F, PA, PB, MH, MHL & MHR

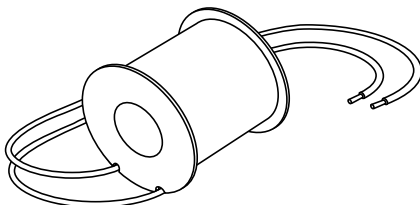

RPI Part #RCK066
OEM Part #144741

SOLENOID BODY KIT

- Includes plunger, spring, spanner nut, and O-ring (RPI Part #RPO301)
- Fits:** Solenoid Valve
- Model:** FL **Type:** 75, 75-C & 7-F

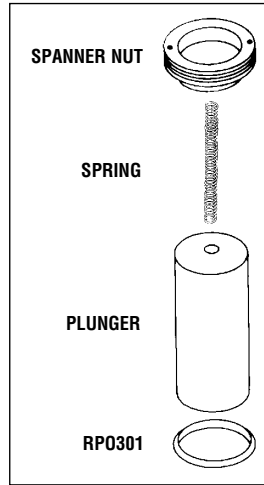

RPI Part #RPO301
OEM Part #C-5970
Industry Part #2-014

O-RING

- 12 per package
- Material: Buna-N (Nitrile)
- Hardness: 70 Duro
- 5/8" OD x 1/2" ID x 1/16" C/S
- Fits:** Solenoid Valve Plunger
- Model:** FL **Type:** 75, 75-C & 7-F

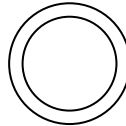

RPI Part #RCC602
OEM Part #143830

FOOT SWITCH CABLE

- Sold by the foot (Reminder: OEM's cable was 5 feet long)
- 7 conductor insulated cable; .53" OD; Jacket 16/7
- For connecting foot control to table
- Models:** All tables and chairs

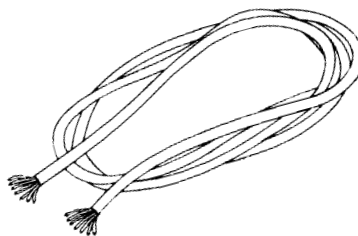

RPI Part #RCM065
OEM Part #141573

MOTOR MOUNT

- 2 per package
- 1/4-20 UNC x 23/64" long x .50" at each end
- Fits:** Motor
- Model:** FL **Type:** 75, 75-C & 7-F

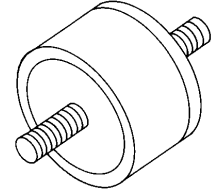

RPI Part #RCM064
OEM Part #155961

VIBRATION MOUNT

- 1/4-20 UNC x .38" long
- Fits:** Motor
- Model:** FL **Type:** 75, 75-C & 7-F

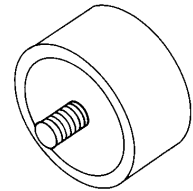

RPI Part #RCP063
OEM Part #C-3872

ROLL PIN

- 12 per package
- 1/8" Diameter x 5/8" long
- Fits:** Tilt Cylinder
- Model:** FL **Type:** 75, 75-C & 7-F

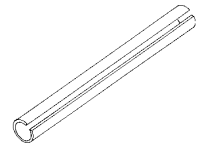

RPI Part #RCP072
OEM Part #425-A-13

STANDPIPE PACKING

- Fits:** Lift Tube
- Model:** FL **Type:** 75, 75-C & 7-F

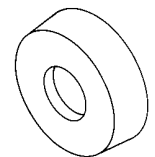

O-Ring illustrations are actual size

Dental Equipment

Model: FL – Type: 75 Series *(continued)*

RPI Part #RCT060
OEM Part #145719

HYDRAULIC TUBING

- Plastic
 - 1/4" OD
- Fits:** Lift Structure
Model: FL Type: 75, 75-C & 7-F

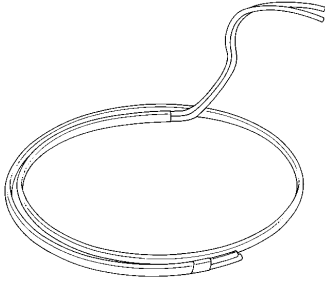

RPI Part #RCI067
OEM Part #108926

BRASS INSERT

- 4 per package
- Fits:** Hydraulic Tubing
Model: FL Type: 75, 75-C & 7-F

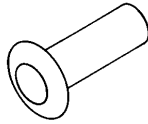

RPI Part #RCN059
OEM Part #C-6760

COMPRESSION NUT WITH FERRULE

- 4 per package
 - 7/16-24
- Fits:** 1/4" Hydraulic Tubing
Model: FL Type: 75, 75-C & 7-F

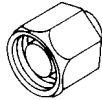

RPI Part #RCS069
OEM Part #155677

FILTER SCREEN

- 6 per package
 - Brass
- Fits:** Hose Assembly that attaches to Cylinder
Model: FL Type: 75, 75-C & 7-F

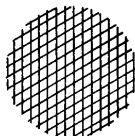

RPI Part #RCS068
OEM Part #143923

UPPER LIMIT SWITCH

- Fits:** Lift Structure
Model: FL Type: 75, 75-C & 7-F

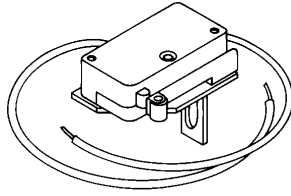

RPI Part #RCS607
OEM Part #10610/P-2400

PIVOT SCREW

- 2 per package
 - Includes screw, and #8 split lock washer
- Fits:** Foot Switch Housing
Model: FL Type: 75, 75-C & 7-F

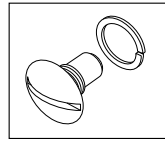

RPI Part #RCS070
OEM Part #155808

LOCK SCREW

- #10-24 x 1" long
- Fits:** Yoke
Model: FL Type: 75, 75-C & 7-F

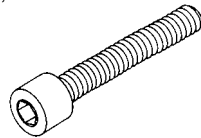

NOTES: _____

Visit the RPI website
www.rpiparts.com
for service tips.

RPI Part #PCS720
OEM Part #007899

EXIT SWITCH ASSEMBLY

- Normally Open
- 3/4A@125VAC
- Black button

Fits: Chair Back Assembly
Model: Chairman

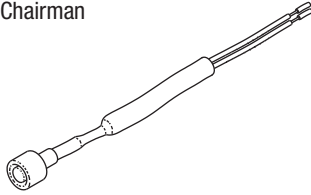

RPI Part #PCS714
OEM Part #007506

FORMED LEVER SWITCH

- 5A@120VAC
- Fits:** Base, Lift & Attachment Assembly
Model: Chairman

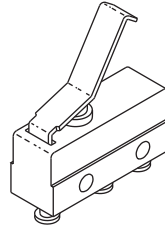

RPI Part #PCS716
OEM Part #007429

TRAVERSE SWITCH

- Momentary contact (On/Off/On)
- 6A@125VAC; 3A@250VAC
- Snap in mounting
- Dark grey paddle

Fits: Back Assembly and Foot Switch Assembly
Model: Chairman

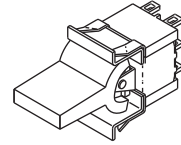

RPI Part #PCS719
OEM Part #007898

OPERATE SWITCH ASSEMBLY

- Normally Open
- 3/4A@125VAC
- Red button

Fits: Chair Back Assembly
Model: Chairman

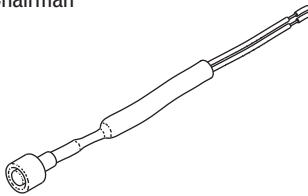

RPI Part #PCS715
OEM Part #007596

TRAVERSE LIMIT SWITCH

- 5A@125/250VAC
- Fits:** Base, Lift & Attachment Assembly
Model: Chairman

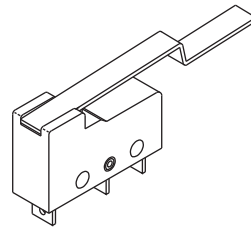

RPI Part #PCS717
OEM Part #007428

TILT SWITCH

- Momentary contact (On/Off/On)
- 6A@125VAC; 3A@250VAC
- Snap in mounting
- White paddle

Fits: Back Assembly (Chairman) and Foot Switch Assembly (Chairman 5090)
Models: Chairman & Chairman 5090

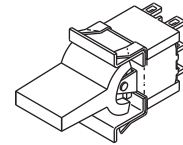

RPI Part #PCS713
OEM Part #007431

ROLLER MICRO SWITCH

- 5A@250VAC
- Fits:** Seat Wiring Assembly
Model: Chairman

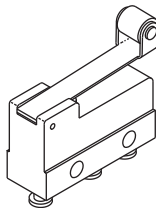

RPI Part #PCP721
OEM Part #007595

FOOT SWITCH PEDAL

- Black ABS plastic
- Fits:** Chair Base Foot Switch Assembly
Model: Chairman

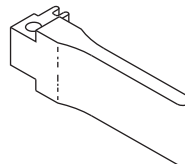

RPI Part #PCS718
OEM Part #007427

LIFT SWITCH

- Momentary contact (On/Off/On)
- 6A@125VAC; 3A@250VAC
- Snap in mounting
- Black paddle

Fits: Back Assembly
Model: Chairman

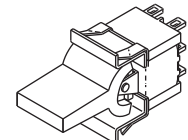

Visit RPI's Website www.rpiparts.com

Dental Equipment

Model: Chairman



RPI Part #PCM745
OEM Part #017628 (Serial #1001-4189) & 007881 (Serial #4190 and above)

LIFT MOTOR

- Includes all parts as shown
- Also available: Grease (RPI Part #RPL717) and Lift Gear (RPI Part #PCG762)

Fits: Base and Lift Assembly
Model: Chairman

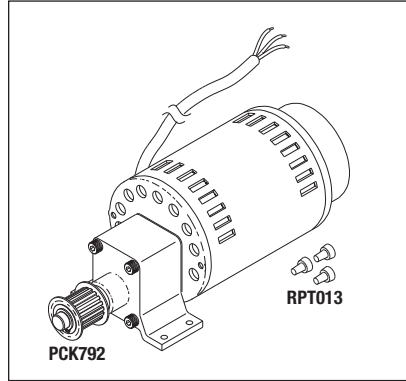

RPI Part #PCK792
OEM Part #007575

LIFT MOTOR PULLEY KIT

- Use with 1" wide XL Series Belt
- 1.146" pitch dia. with 18 grooves
- .500" bore with .125" key slot
- Includes: pulley, woodruff key, and (2) retaining rings

Fits: Lift Motor
Model: Chairman

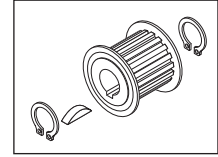

RPI Part #PCK742
OEM Part #011195

BRAKE REPAIR KIT

- Clutch material: ScnaPac 230-F (non-asbestos)
- Includes all parts as shown

Fits: Lift Motor, Base and Lift Assembly
Model: Chairman

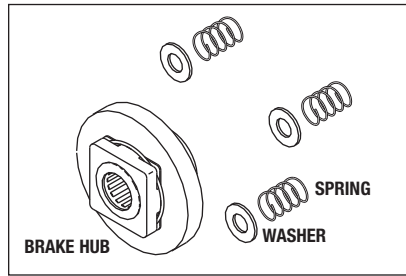

RPI Part #PCG762
OEM Part #024770

LIFT GEAR

- 39 Teeth, Helical
- Includes: Grease (RPI Part #RPL717)

Fits: Lift Motor
Model: Chairman

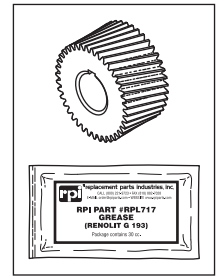

RPI Part #PCK738
OEM Part #012476

GEAR AND RACK

- Steel
- Includes all parts as shown

Fits: Base, Lift and Assembly
Model: Chairman

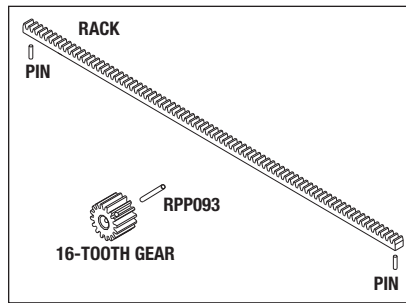

RPI Part #PCG739
OEM Part #022701

TRAVERSE GEAR (SINGLE)

- 17 Teeth
- Includes: Grease (RPI Part #RPL717)

Fits: Traverse Motor
Model: Chairman

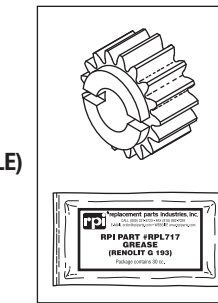

RPI Part #PCB729
OEM Part #017850

PCB ASSEMBLY

- New style PCB

Fits: Seat Assembly
Model: Chairman

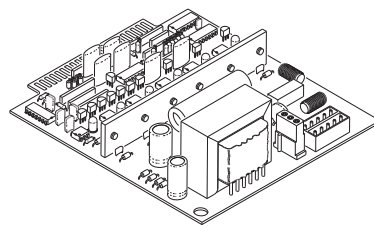

RPI Part #PCG740
OEM Part #024766

TRAVERSE GEAR (DOUBLE)

- 16 Teeth/35 Teeth
- Includes: Grease (RPI Part #RPL717)

Fits: Traverse Motor
Model: Chairman

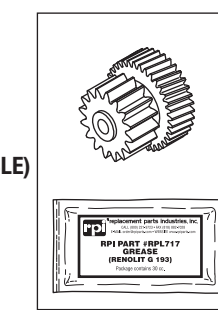

RPI Part #PCC746
OEM Part #007903

COILING WIRE ASSEMBLY

- 14 conductor; #22 AWG
- Rubber boot cover on pin housing

Fits: Seat Support Assembly
Model: Chairman

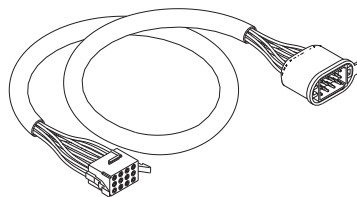

RPI Part #RPL717
OEM Part # (No OEM Part # Available)

GREASE

- 30cc package
- Renolit G 193 Grease
- To be used with gears on Lift Motor and Traverse Motor

Model: Chairman



RPI Part #PCA747
OEM Part #007660

AUTO RECLINE ACTUATOR

- Nylon®
- Includes all parts as shown

Fits: Beam and Traverse Assembly
Model: Chairman

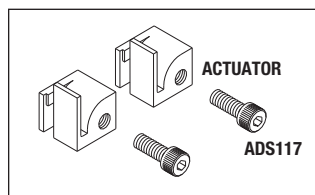

RPI Part #PCC728
OEM Part #9441643

LIFT CAPACITOR

- Electrolytic medium
- 53-64 μ f; 220/250VAC
- Fits:** Base motor/lift motor
- Models:** Chairman 5000 & Coachman

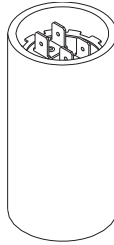

RPI Part #PCC734
New OEM Part #7731904
Old OEM Part #019518

CAPACITOR

- Electrolytic medium
- 21-25 μ f; 220/250VAC
- Fits:** Incline/recline and upper traverse
- Models:** Chairman 5000 & Coachman

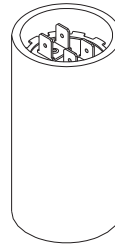

RPI Part #PCS731
OEM Part #1525737

CORRECTION LIMIT SWITCH

- 10A@125 VAC
- Fits:** Lift motor
- Model:** Chairman 5000

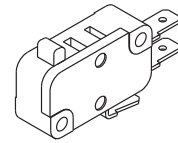

RPI Part #PCB730
OEM Part #040988

FOOT SWITCH ASSEMBLY (PCB)

- Includes all parts as shown
- Fits:** Foot switch assembly
- Models:** Chairman 5000 & 5010

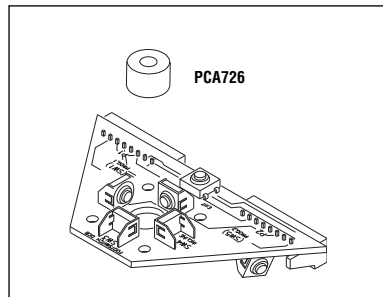

RPI Part #PCS735
OEM Part #7740947

AC POWER SWITCH

- 16A@125/250VAC
- Use only with 240V models
- Fits:** Inner base assembly
- Models:** Chairman 5000 (240VAC models only)

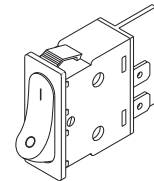

RPI Part #PCA726
OEM Part #5428292

ACTUATOR SPACER

- 4 per package
- Closed cell neoprene
- Fits:** Foot Switch Assembly (PCB)
- Models:** Chairman 5000 & 5010



RPI Part #PCB736
New OEM Part #9434424

UP INTERCONNECT (PCB)

- Fits:** Incline/recline controls
- Models:** Chairman 5000 & 5010

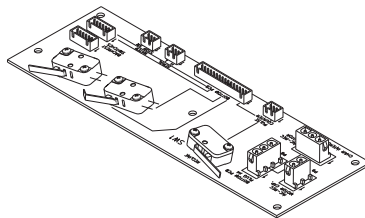

RPI Part #PCS717
OEM Part #007428

TILT SWITCH

- Momentary contact (On/Off/On)
- 6A@125VAC; 3A@250VAC
- Snap in mounting
- White paddle
- Fits:** Back assembly (Chairman) and Foot Switch Assembly (Chairman 5090)
- Model:** Chairman & Chairman 5090

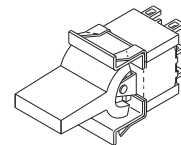

RPI Part #PCB733
New OEM Part #3006629

LIMIT SWITCH (PCB)

- Fits:** Incline/recline and upper traverse
- Models:** Chairman 5090

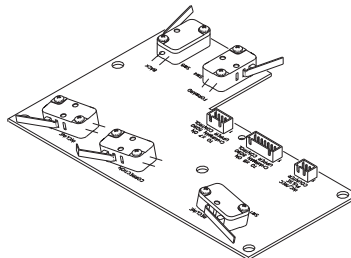

RPI Part #PCA737
OEM Part #1899702

FOOT SWITCH & CABLE ASSEMBLY

- Momentary contact (On/Off/On)
- 6A@125V; 3A@250V
- Snap in mounting
- White paddle
- Fits:** Inner base
- Models:** Chairman 5090

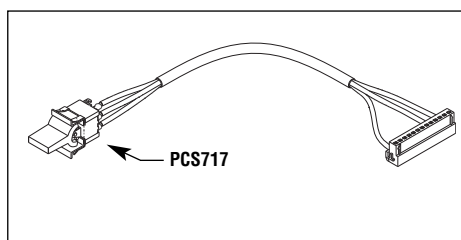

RPI Part #RPF367
OEM Part #1881163

FUSE (2A, 250VAC)

- 5 per package
- Size: 5 mm x 20 mm (.197" x .787")
- Glass, Fast-Acting
- Fits:** Inner base assembly (240V models only)
- Models:** Chairman 5000 & 5010

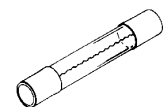

Dental Equipment

Models: Coachman & Coachman II

**RPI Part #PCC728
OEM Part #9441643**

LIFT CAPACITOR
 • Electrolytic medium
 • 53-64 µf; 220/250VAC
Fits: Base motor/lift motor
Models: Chairman 5000 & Coachman

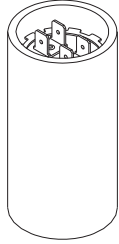

**RPI Part #PCC734
New OEM Part #7731904
Old OEM Part #019518**

CAPACITOR
 • Electrolytic medium
 • 21-25 µf; 220/250VAC
Fits: Incline/recline and upper traverse
Models: Chairman 5000 & Coachman

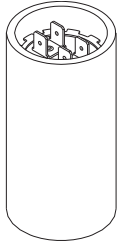

**RPI Part #PCB723
New OEM Part #018326**

SWITCH BACK PCB ASSEMBLY
Fits: Chair back assembly
Models: Coachman

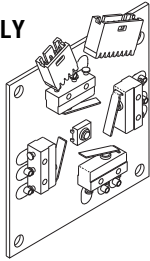

**RPI Part #PCS724
OEM Part #018420**

MICRO-SWITCH
 • 5A@250VAC
Fits: Switch Back PCB Assembly
Model: Coachman

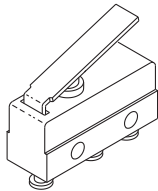

**RPI Part #PCS722
OEM Part #023944**

FOOT SWITCH MICRO-SWITCH
 • 15A@125VAC
Fits: 4-way foot switch assembly
Models: Coachman & Coachman II

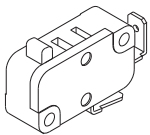

**RPI Part #PCS725
OEM Part #018956**

MOTOR LIMIT SWITCH
 • 15A@120VAC
Fits: Base assembly
Models: Coachman & Coachman II

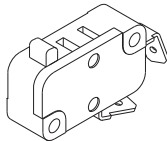

NOTES: _____

Air Techniques, Apollo/Midmark®, MDT McKesson, DentalEZ®/Custom Air/RamVac, Jun-Air, Matrux/Midmark®, Midmark®, Pelton & Crane, and Tech West/Turbine Ind.

LUBRICATED COMPRESSOR PM KITS TO FIT APOLLO/MIDMARK®

RPI Parts Included In PM Kits

RPI Part #	OEM Part #	Models	RPI Parts Included In PM Kits				
			Air Intake Filter Elements	Coalescing Filter Elements		Oil	Acc.
			CME004	CMK024	CMK025	CML001	RPB838
CMK173	ACA85407	ALCQL82/D	4		1	4	1
CMK160	ACA85402	ALCRL62/D	3		1	3	1
CMK167	ACA85400	ALCSL11/D, 12/D, 21/D, & 22/D	1	1		1	1
CMK159	ACA85401	ALCTL31/D, 32/D, 41/D & 42/D	2		1	2	1

Also Available! Syringe Pump/Extractor (RPI Part #RPT842), Drain Valve (RPI Part #RPV841), Bottle (1 Liter/32 fl. oz.) (RPI Part #RPB939), and Absorbant Pad (RPI Part #RPP958) - see page 430 for more information.

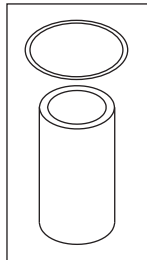

CME004

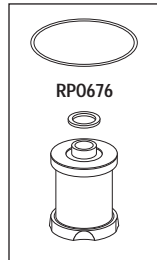

CMK024

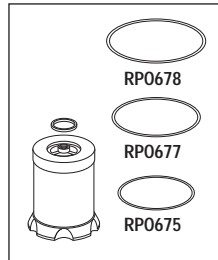

CMK025



CML001

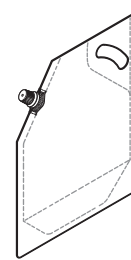

RPB838

It's the RPI Advantage! RPI PM Kits also include a PM Check List as well as a PM Sticker that can be attached to the compressor for recording the date that the filters and compressor oil were replaced.

LUBRICATED COMPRESSOR PM KITS TO FIT DENTALEZ®/CUSTOM AIR/RAMVAC

RPI Parts Included In PM Kits

RPI Part #	OEM Part #	Models	RPI Parts Included In PM Kits						
			Air Intake Filter Elements	Coalescing Filter Elements		Oil	Acc.		
			CMF073	CME104	CME105	CML119	RPB838	RP0848	CMG197
DENTALEZ®/CUSTOM AIR/RAMVAC									
CMK152	65468176	CA-711 & 721	1	1	1	2	1	1	1
CMK153	65468177	CA-713 & 723	2	1	1	4	1	2	2
CMK154	65468178	CA-725	4	1	1	6	1	4	4

Also Available! Syringe Pump/Extractor (RPI Part #RPT842), Drain Valve (RPI Part #RPV841), Bottle (1 Liter/32 fl. oz.) (RPI Part #RPB939), and Absorbant Pad (RPI Part #RPP958) - see page 430 for more information.



CME104

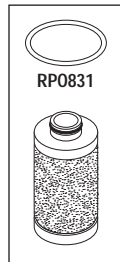

CME105

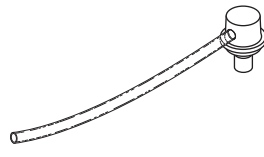

CMF073



CMG197

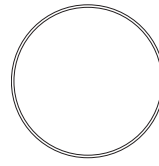

RP0848
Not Shown
Actual Size

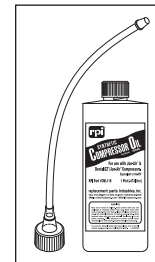

CML119

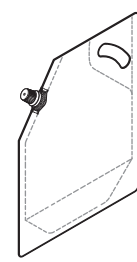

RPB838

It's the RPI Advantage! RPI PM Kits also include a PM Check List as well as a PM Sticker that can be attached to the compressor for recording the date that the filters and compressor oil were replaced.

NOTES: _____

Dental Equipment

Air Techniques, Apollo/Midmark®, MDT McKesson, DentalEZ®/Custom Air/RamVac, Jun-Air, MatrX/Midmark®, Midmark®, Pelton & Crane, and Tech West/Turbine Ind.

LUBRICATED COMPRESSOR PM KITS TO FIT MATRX/MIDMARK®

RPI Parts Included In PM Kits

RPI Part #	OEM Part #	Models	Air Intake Filter Elements		Coalescing Filter Elements	Oil	Acc.
			CME004	CMF013	CMF014	CMK024	CML001
MATRX/MIDMARK®							
CMK185	No OEM Part # Available	AMD-2 & 2-115		3		1	1
CMK186	No OEM Part # Available	AMD-4		3		1	2
CMK187	No OEM Part # Available	AMD-6		4		1	3
CMK167	77000958	AMD-100 & 101	1			1	1
CMK168	77000959	AMD-100-2	2			1	2
CMK169	77000960	AMD-100-3	3			1	3
CMK263	No OEM Part # Available	AMD-100 & AMD-102 (Manufactured before Midmark acquired MatrX)		3		1	1
CMK264	No OEM Part # Available	AMD-100-2 (Manufactured before Midmark acquired MatrX)		5		1	2
CMK265	No OEM Part # Available	AMD-100-3 (Manufactured before Midmark acquired MatrX)		6		1	3
CMK266	No OEM Part # Available	AC-075, AC-100 & AC-101		3			1
CMK267	No OEM Part # Available	AC-100-2		5			2
CMK268	No OEM Part # Available	ACD-075, ACD-100 & ACD-101			2	1	1
CMK269	No OEM Part # Available	ACD-100-2			4	1	2

Also Available! Syringe Pump/Extractor (RPI Part #RPT842), Drain Valve (RPI Part #RPV841), Bottle (1 Liter/32 fl. oz.) (RPI Part #RPB939), and Absorbant Pad (RPI Part #RPP958) - see page 430 for more information.

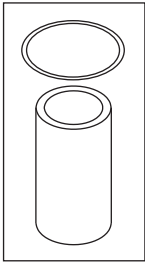

CME004

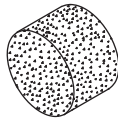

CMF013

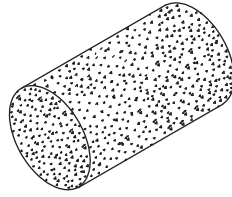

CMF014

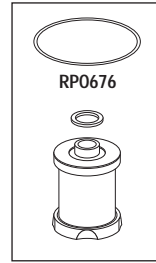

CMK024

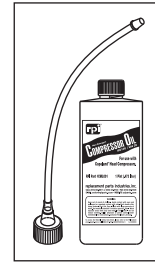

CML001

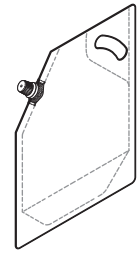

RPB838

It's the RPI Advantage! RPI PM Kits also include a PM Check List as well as a PM Sticker that can be attached to the compressor for recording the date that the filters and compressor oil were replaced.

LUBRICATED COMPRESSOR PM KITS TO FIT MIDMARK®

RPI Parts Included In PM Kits

RPI Part #	OEM Part #	Models	Air Intake Filter Elements		Coalescing Filter Elements	Oil	Acc.
			CME004		CMK025	CML001	RPB838
MIDMARK®							
CMK158	77001633	CL21 & CL22	1		1	1	1
CMK159	77001634	CL32	2		1	2	1
CMK160	77001635	CL52	3		1	3	1

Also Available! Syringe Pump/Extractor (RPI Part #RPT842), Drain Valve (RPI Part #RPV841), Bottle (1 Liter/32 fl. oz.) (RPI Part #RPB939), and Absorbant Pad (RPI Part #RPP958) - see page 430 for more information.

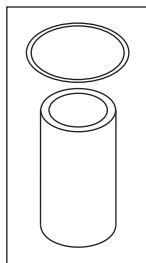

CME004

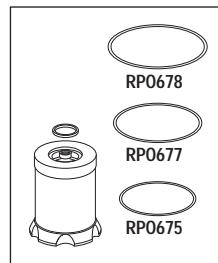

CMK025



CML001

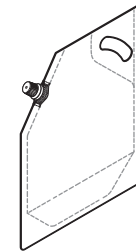

RPB838

It's the RPI Advantage! RPI PM Kits also include a PM Check List as well as a PM Sticker that can be attached to the compressor for recording the date that the filters and compressor oil were replaced.

FAX: (818) 882-7028 • E-MAIL: order@rpiarts.com • WEBSITE: www.rpiarts.com

LUBRICATED COMPRESSOR PM KITS TO FIT

TECH WEST

RPI Parts Included In PM Kits

RPI Part #	OEM Part #	Models	Air Intake Filter Elements		Coalescing Filter Elements		Oil	Acc.
			CME067	CME069	CME110	CMK025	CML001	RPB838
TECH WEST								
CMK188	CSKL-1	ACL2S1/ND & ACL2S2/ND (2005 and earlier)	1			1	1	1
CMK182	CSKL-1P	ACL2S1 & 2S2 (2006 and later)	1		1		1	1
CMK189	CSKL-2	ACL4D2/ND (2005 and earlier)	1			1	2	1
CMK183	CSKL-2P	ACL4D2 (2006 and later)	1		1		2	1
CMK190	CSKL-3	ACL6T2/ND (2005 and earlier)		1		1	3	1
CMK184	CSKL-3P	ACL6T2 (2006 and later)		1	1		3	1

Also Available! Syringe Pump/Extractor (RPI Part #RPT842), Drain Valve (RPI Part #RPV841), Bottle (1 Liter/32 fl. oz.) (RPI Part #RPB939), and Absorbant Pad (RPI Part #RPP958) - see page 430 for more information.

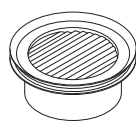

CME067



CME069

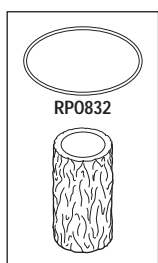

CME110

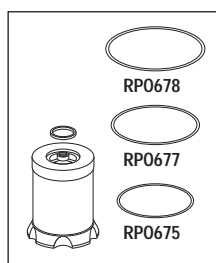

CMK025



CML001

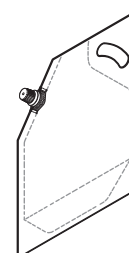

RPB838

It's the RPI Advantage! RPI PM Kits also include a PM Check List as well as a PM Sticker that can be attached to the compressor for recording the date that the filters and compressor oil were replaced.

NOTES:

Dental Equipment

Air Techniques, Apollo/Midmark®, MDT McKesson, DentalEZ®/Custom Air/RamVac, Jun-Air, Matrix/Midmark®, Midmark®, Pelton & Crane, and Tech West/Turbine Ind.

OIL-LESS COMPRESSOR PM KITS TO FIT AIR TECHNIQUES

RPI Part #	OEM Part #	Models	RPI Parts Included In PM Kits		
			Air Intake Filter Elements	Coalescing and Particulate Filter Elements	
			CMK065	CME102	CME103
AIR TECHNIQUES					
CMK141	87351	AirStar 10M, 10NEO & 12M	1	1	1
CMK142	87352	AirStar 21M, 21NEO, 22M, 22NEO, 30M & 30NEO	2	1	1
CMK199	87355	AirStar 40M & 40NEO	3	1	1
CMK143	87353	AirStar 50M & 50NEO	4	1	1
CMK144	87354	AirStar 70M & 70NEO	6	2	2
CMK278	87356	AirStar 100M	8	2	2

It's the RPI Advantage! RPI PM Kits also include a PM Check List as well as a PM Sticker that can be attached to the compressor for recording the date that the filters were replaced.

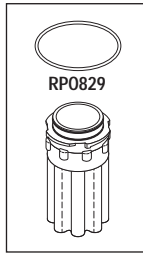

CME102

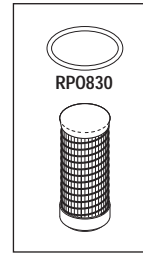

CME103

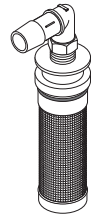

CMK065

OIL-LESS COMPRESSOR PM KITS TO FIT APOLLO/MIDMARK®

RPI Part #	OEM Part #	Models	RPI Parts Included In PM Kits						
			Air Intake Filter Elements			Coalescing and Particulate Filter Elements			Tip Seal Kit
			CME004	CME281	CME288	CME085	CMK024	CMK025	CMK287
APOLLO/MIDMARK®									
CMK170	ACA85403 & ACA85417	AOCOS11/D/DQ/Q, 12/D/DQ/Q, 21/D/DQ/Q, AOCOS22/D/DQ/Q, AOCRT21DQ/Q, AOCRT22DQ/Q & R22 (with 10 gal tank)	2				1		
CMK171	ACA85404	AOCOS31/D/DQ/Q, 32/D/DQ/Q, 42/D/DQ/Q, AOCOT32/D/DQ/Q & 42/D/DQ/Q	4					1	
CMK172	ACA85406	AOCOT62/D/DQ/Q & 82/D/DQ/Q	8					1	
CMK270	No OEM Part # Available	AOCRS11 & AOCRS12 (Manufactured before Apollo was acquired by Midmark)			1	1			
CMK271	No OEM Part # Available	AOCRS11 & AOCRS12 (Manufactured after Apollo was acquired by Midmark)	1			1			
CMK273	ACA85418	AOCRR42DQ, R42 & R22 (with 20, 30, or 40 gal tank)	3					1	
CMK274 ¹	ACA85415	AOCOS52, AOCOS52D		1				1	
CMK286 ¹	ACA85416	AOCOS52, AOCOS52D		1				1	1
CMK287	HPA30505	AOCOS52, AOCOS52D							1

Footnotes: ¹ This Kit only fits Compressors that have been upgraded with the RPI Air Intake Upgrade Kit (Round Style Housing) (RPI Part #CMK280), refer to page 423.

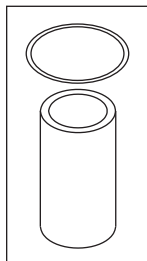

CME004

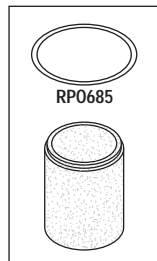

CME085

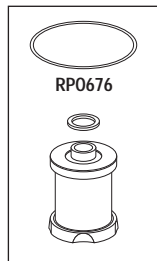

CMK024

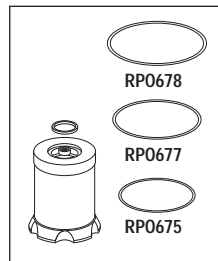

CMK025



CME281

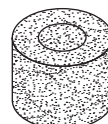

CME288

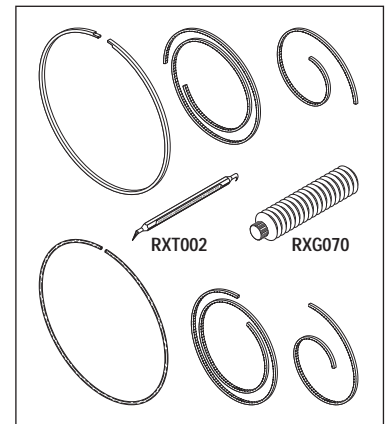

CMK287

It's the RPI Advantage! RPI PM Kits also include a PM Check List as well as a PM Sticker that can be attached to the compressor for recording the date that the filters were replaced.

OIL-LESS COMPRESSOR PM KITS TO FIT DENTALEZ®/CUSTOM AIR/JUN-AIR/RAMVAC

RPI Part #	OEM Part #	Models	RPI Parts Included In PM Kits								
			Air Intake Filter Elements				Coalescing and Particulate Filter Elements				
			CME067	CME074	CMF073	CMF075	CME043	CME044	CME105	CME107	CME227
DENTALEZ®/CUSTOM AIR/JUN-AIR/RAMVAC											
CMK076 ¹	004016	1013D, 1023D, 1025D & 1027D	2					1	1		
CMK092 ¹	004015	1022	1					1	1		
CMK101 ¹	004017	1029T	3					1	1		
CMK145	65468179	CA-812, 822, 912 & 922		1						2	
CMK146	65468180	CA-813-D & 823-D (SN 440537 and below)			2					2	
CMK147	65468186	CA-813/D, 823/D, 913 & 923 (SN 440538 - 631602)				4				2	
CMK191	004444	CA-813/D, 823/D, 913 & 923 (SN 631603 and above)				4				2	
CMK148	65468181	CA-825/D/O & 925/D (SN 631602 and below)		2						2	
CMK192	004445	CA-825/D/O & 925/D (SN 631603 and above)		2						2	
CMK149	65468182	CA-827-D & 927-D (SN 631602 and below)		3						2	
CMK193	004446	CA-827-D & 927-D (SN 631603 and above)		3						2	
CMK150	65468183	CA-829-D & 929-D (SN 631602 and below)		4						2	
CMK194	004449	CA-829-D & 929-D (SN 631603 and above)		4						2	
CMK151	65468184	CA-8212-T (SN 631602 and below)		6						2	
CMK195	004447	CA-8212-T (SN 631603 and above)		6						2	
CMK223	005147SP	Osprey 13, Osprey 22, & Osprey 23	2								1 1
CMK226	005350SP	Osprey 24	3								1 1
CMK224	005148SP	Osprey 25	4								1 1
CMK225	005149SP	Osprey 28	6								1 1

Footnotes: ¹ Fits only DentalEZ/Custom Air/RamVac Compressors

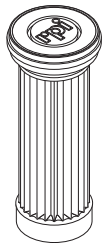

CME074

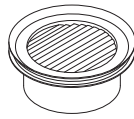

CME067



CMF073

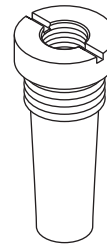

CMF075

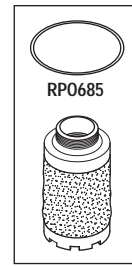

CME043

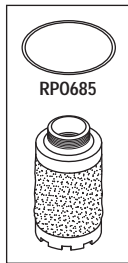

CME044

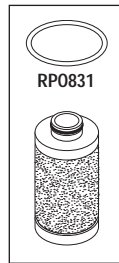

CME105

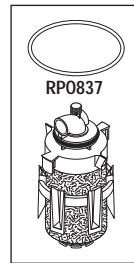

CME107

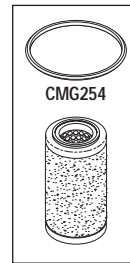

CME227

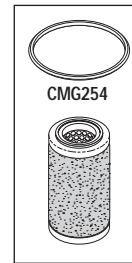

CME228

It's the RPI Advantage! RPI PM Kits also include a PM Check List as well as a PM Sticker that can be attached to the compressor for recording the date that the filters were replaced.

NOTES:

Dental Equipment

Air Techniques, Apollo/Midmark®, MDT McKesson, DentalEZ®/Custom Air/RamVac, Jun-Air, Matrx/Midmark®, Midmark®, Pelton & Crane, and Tech West/Turbine Ind.

OIL-LESS COMPRESSOR PM KITS TO FIT MATRX/MIDMARK®

RPI Parts Included In PM Kits

RPI Part #	OEM Part #	Models	Air Intake Filter Elements		Coalescing and Particulate Filter Elements
			CME071	CMF013	CMK024
MATRX/MIDMARK®					
CMK161	No OEM Part # Available	OL-100 & 101		3	1
CMK162	No OEM Part # Available	OL-100-2		5	1
CMK163	No OEM Part # Available	OL-100-3		6	1
CMK164	No OEM Part # Available	OL-3, 2000 & 2001	2		1
CMK165	No OEM Part # Available	OL-7 & 4000	4		1
CMK166	No OEM Part # Available	OL-10 & 6000	6		1

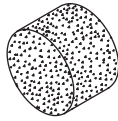

CMF013

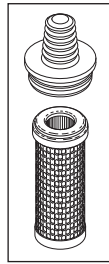

CME071

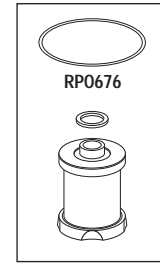

CMK024

It's the RPI Advantage! RPI PM Kits also include a PM Check List as well as a PM Sticker that can be attached to the compressor for recording the date that the filters were replaced.

OIL-LESS COMPRESSOR PM KITS TO FIT MIDMARK®

RPI Parts Included In PM Kits

RPI Part #	OEM Part #	Models	Air Intake Filter Elements			Coalescing and Particulate Filter Elements	Tip Seal Kit
			CME004	CME071	CME281	CMK025	CMK287
MIDMARK®							
CMK155	77001636	P21 & P22	2			1	
CMK198	77001636	P32	3			1	
CMK156	77001610	P52		4		1	
CMK157	77001611	P72		6		1	
CMK274 ¹	ACA85415	S52			1	1	
CMK286 ¹	ACA85416	S52			1	1	1
CMK287	HPA30505	S52					1

Footnotes: ¹ This Kit only fits Compressors that have been upgraded with the RPI Air Intake Upgrade Kit (Round Style Housing) (RPI Part #CMK280), refer to page 403.

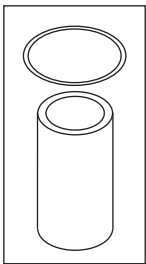

CME004

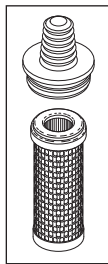

CME071

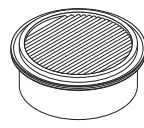

CME281

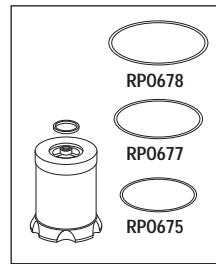

CMK025

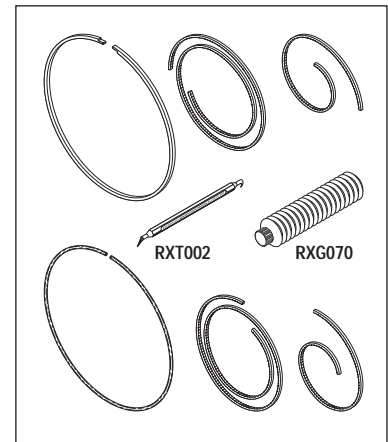

CMK287

It's the RPI Advantage! RPI PM Kits also include a PM Check List as well as a PM Sticker that can be attached to the compressor for recording the date that the filters were replaced.

OIL-LESS COMPRESSOR PM KITS TO FIT TECH WEST

RPI Parts Included In PM Kits

RPI Part #	OEM Part #	Models	Air Intake Filter Elements		Coalescing and Particulate Filter Elements	
			CME067	CME069	CME110	CMK025
TECH WEST						
CMK174	CSKO-1	ACO2S1/ND & ACO2S2/ND (2005 and earlier)	2			1
CMK175	CSKO-1P	ACO2S1/ND & ACO2S2/ND (2006 and later)	2		1	
CMK176	CSKO-2	ACO4S2/ND & ACO4D2/ND (2005 and earlier)	4			1
CMK177	CSKO-2P	ACO4D2/ND (2006 and later)	4		1	
CMK178	CSKO-3	ACO6T2/ND (2005 and earlier)	6			1
CMK179	CSKO-3P	ACO6T2/ND (2006 and later)	6		1	
CMK275	No OEM Part # Available	ACOR2D1, ACOR2D1Q, ACOR2D2, ACOR2D2Q, ACOR3T2 & ACOR3T2Q	1		1	
CMK277	No OEM Part # Available	ACOR4Q2		1	1	

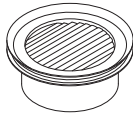

CME067

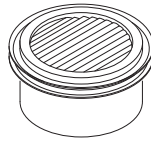

CME069

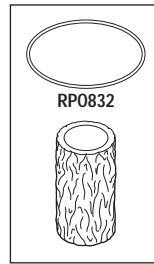

CME110

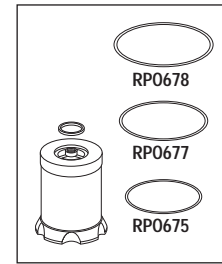

CMK025

It's the RPI Advantage! RPI PM Kits also include a PM Check List as well as a PM Sticker that can be attached to the compressor for recording the date that the filters were replaced.

NOTES:

Air Techniques, Apollo/Midmark®, MDT McKesson, DentalEZ®/Custom Air/RamVac, Jun-Air, Matrix/Midmark®, Midmark®, Pelton & Crane, and Tech West/Turbine Ind.

COALESCING FILTER ASSEMBLY (5 oz.) & REPLACEMENT PARTS

RPI PART #	DESCRIPTION	AIR TECHNIQUES	APOLLO/MIDMARK®	DENTAL EZ®/CUSTOM AIR/RAMVAC	JUN-AIR	MATRIX/MIDMARK®	MIDMARK®
CMA021	COALESCING FILTER ASSEMBLY (WILKERSON® Part #M16-03-FMO)	No OEM Part # Available	ACA70305			77005010	62985200
CMB087	MOUNTING BRACKET	No OEM Part # Available	No OEM Part # Available			No OEM Part # Available	No OEM Part # Available
CMC086	BLANK COVER	No OEM Part # Available	No OEM Part # Available	No OEM Part # Available	No OEM Part # Available	No OEM Part # Available	No OEM Part # Available
CMK005	COALESCING FILTER ELEMENT (WILKERSON® Part #MSP-95-988) • Type B, 0.5 micron		ACA86050 Type B, Wilkerson Filter only	648-00209 Type B, Wilkerson Filter only	648-00209 Type B, Wilkerson Filter only	77005005 Type B, Wilkerson Filter only	77005009 Type B, Wilkerson Filter only
CMK024	COALESCING FILTER ELEMENT (WILKERSON® Part #MTP-95-548) • Type C, 0.01 micron		ACA86050 Type C, Wilkerson Filter only	648-00209 Type C, Wilkerson Filter only	648-00209 Type C, Wilkerson Filter only	77005005 Type C, Wilkerson Filter only	77005009 Type C, Wilkerson Filter only
CMK026	COALESCING FILTER ELEMENT (GENERIC BRAND) • Type C, 0.01 micron		ACA86050 Type C, Generic Filter only	648-00209 Type C, Generic Filter only	648-00209 Type C, Generic Filter only	77005005 Type C, Generic Filter only	77005009 Type C, Generic Filter only
CMIO15	DIFFERENTIAL PRESSURE INDICATOR (WILKERSON® Part #DP2-01-000)		AAP85210			77002134	65907600
CMF016	AUTO DRAIN FLOAT (WILKERSON® Part #GRP-95-981)		ACA85210	645-45010 Wilkerson Auto Float Drain only			
RPF651	ADAPTOR FITTING		No OEM Part # Available	No OEM Part # Available			

RPI Part #CMA021
OEM Part #'s - See Chart Above

COALESCING FILTER ASSEMBLY (5 oz.)

- Wilkerson® (M16-03-FMO)
- Includes:
 - Adaptor Fitting (RPI Part #RPF651)
 - Auto Drain Float (RPI Part #CMF016)
 - Coalescing Filter Element (RPI Part #CMK024)
 - Differential Pressure Indicator (RPI Part #CMIO15)
 - PM sticker
- All parts also sold separately

It's the RPI Advantage! Also includes an attached PM Sticker for recording the date that the filter housing was replaced.

Also available:
Mounting Bracket
(RPI Part #CMB087)

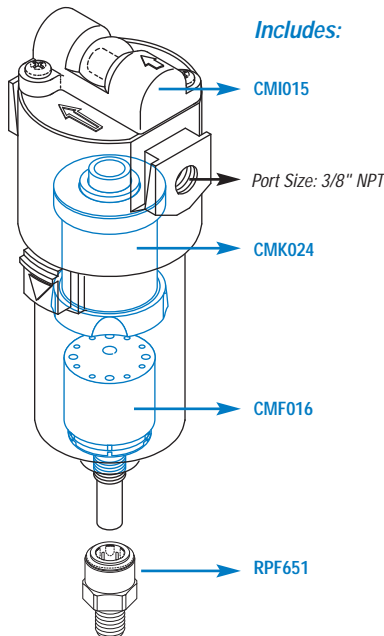
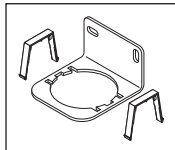

Includes:

RPI Part #CMK024
OEM Part #'s - See Chart Above

COALESCING FILTER ELEMENT

- Wilkerson® (MTP-95-548)
 - Size: 1.59" OD x 2.05" lg.
 - Type C; 0.01 micron
 - Includes all parts as shown and PM sticker
- Fits: Wilkerson® brand M16 (5 oz.) Series Filter Assembly



RPI Part #CMK026
OEM Part #'s - See Chart Above

COALESCING FILTER ELEMENT

- Generic brand
 - Size: 1.75" OD x 2.03" lg.
 - Type C; 0.01 micron
 - Includes all parts as shown and PM sticker
- Fits: Wilkerson® brand M16 (5 oz.) Series Filter Assembly



RPI Part #CMC086
OEM Part #'s - See Chart Above

BLANK COVER

- Wilkerson® brand
 - Black plastic
 - Includes all parts as shown
 - Replaces Differential Pressure Indicator (RPI Part #CMIO15)
- Fits: Wilkerson® brand M16 (5 oz.) & M26 (10 oz.) Series Filter Assembly

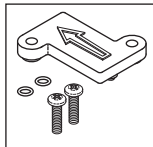

RPI Part #CMIO15
OEM Part #'s - See Chart Above

DIFFERENTIAL PRESSURE INDICATOR

- Wilkerson® brand
 - Includes: screws and O-rings
 - Also available: Coalescing Filter Assembly (RPI Part #'s CMA021 & CMA022)
- Fits: Wilkerson® brand M16 (5 oz.) & M26 (10 oz.) Series Filter Assembly

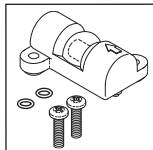

RPI Part #CMF016
OEM Part #'s - See Chart Above

AUTO DRAIN FLOAT

- Wilkerson® brand
 - Includes: O-ring, nut and Adaptor Fitting (RPI Part #RPF651)
 - Also available: Coalescing Filter Assembly (RPI Part #'s CMA021 & CMA022)
- Fits: Wilkerson® brand M16 (5 oz.) & M26 (10 oz.) Series Filter Assembly

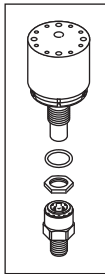

RPI Part #RPF651
OEM Part #'s - See Chart Above

ADAPTOR FITTING (3/8" TUBE X 1/8" MPT)

- Material: Acetal
- Fits: Wilkerson® brand M16 (5 oz.) & M26 (10 oz.) Series Filter Assembly



RPI Part #CMK005
OEM Part #'s - See Chart Above

COALESCING FILTER ELEMENT

- Wilkerson® (MSP-95-988)
 - Size: 1.59" OD x 2.05" lg.
 - Type B; 0.5 micron
 - Includes all parts as shown and PM sticker
- Fits: Wilkerson® brand M16 (5 oz.) Series Filter Assembly



RPI Part #CMB087
OEM Part #'s - See Chart Above

MOUNTING BRACKET

- Wilkerson® brand
- "L" type bracket; Wall mount
- Use this bracket to externally mount the Coalescing Filter Assembly to the wall. *It's the RPI Advantage!*

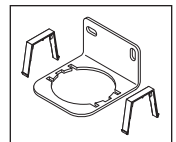

Fits: Wilkerson® brand F16 & M16 (5 oz.) Series Coalescing Filter Assemblies

COALESCING FILTER ASSEMBLY (10 oz.) & REPLACEMENT PARTS

RPI PART #	DESCRIPTION	AIR TECHNIQUES	APOLLO/MIDMARK®	DENTAL EZ®/CUSTOM AIR/RAMVAC	JUN-AIR	MATRX/MIDMARK®	MIDMARK®	TECH WEST
CMA022	COALESCING FILTER ASSEMBLY (WILKERSON® Part #M26-03-FMO)	No OEM Part # Available	ACA85215	645-45010	JA4081500			CFA-375
CMB088	MOUNTING BRACKET	No OEM Part # Available	No OEM Part # Available			No OEM Part # Available	No OEM Part # Available	
CMC086	BLANK COVER	No OEM Part # Available	No OEM Part # Available	No OEM Part # Available	No OEM Part # Available	No OEM Part # Available	No OEM Part # Available	No OEM Part # Available
CMF016	AUTO DRAIN FLOAT (WILKERSON® Part #GRP-95-981)		ACA85210	645-45010 Wilkinson Auto Float Drain only				
CMK006	COALESCING FILTER ELEMENT (WILKERSON® Part #MSP-95-989) • Type B, 0.5 micron		ACA86055 Type B, Wilkerson Filter only	645-45010 Type B, Wilkerson Filter only	JA4081500 Type B, Wilkerson Filter only		77005002	CFE-375 Type B, Wilkerson Filter only
CMK025	COALESCING FILTER ELEMENT (WILKERSON® Part #MTP-95-549) • Type C, 0.01 micron		ACA86055 Type C, Wilkerson Filter only	645-45010 Type C, Wilkerson Filter only	JA4081500 Type C, Wilkerson Filter only			CFE-375 Type C, Wilkerson Filter only
CMK027	COALESCING FILTER ELEMENT (GENERIC BRAND) • Type C, 0.01 micron		ACA86055 Type C, Generic Filter only	645-45010 Type C, Generic Filter only	JA4081500 Type C, Generic Filter only			CFE-375 Type C, Generic Filter only
CMIO15	DIFFERENTIAL PRESSURE INDICATOR (WILKERSON® Part #DP2-01-000)		AAP85210			77002134	65907600	CI-100
RPF651	ADAPTOR FITTING		No OEM Part # Available	No OEM Part # Available				

RPI Part #CMA022
OEM Part #'s - See Chart Above

COALESCING FILTER ASSEMBLY (10 oz.)

- Wilkerson® (M26-03-FMO)
- Includes:
 - Adaptor Fitting (RPI Part #RPF651)
 - Auto Drain Float (RPI Part #CMF016)
 - Coalescing Filter Element (RPI Part #CMK025)
 - Differential Pressure Indicator (RPI Part #CMIO15)
 - PM sticker
- All parts also sold separately

It's the RPI Advantage! Also includes an attached PM Sticker for recording the date that the filter housing was replaced.

Also available:
Mounting Bracket
(RPI Part #CMB088)

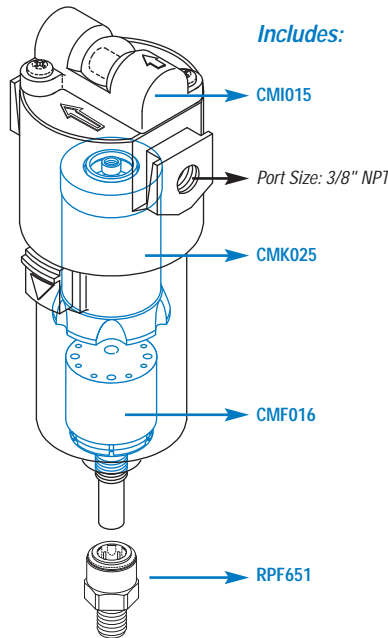
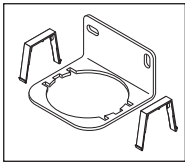

Includes:

RPI Part #CMC086
OEM Part #'s - See Chart Above

BLANK COVER

- Wilkerson® brand
- Black plastic
- Includes all parts as shown
- Replaces Differential Pressure Indicator (RPI Part #CMIO15)
- Fits: Wilkerson® brand M16 (5 oz.) & M26 (10 oz.) Series Filter Assembly

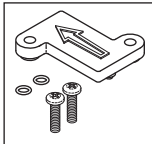

RPI Part #CMIO15
OEM Part #'s - See Chart Above

DIFFERENTIAL PRESSURE INDICATOR

- Wilkerson® brand
- Includes: screws and O-rings
- Also available: Coalescing Filter Assembly (RPI Part #'s CMA021 & CMA022)
- Fits: Wilkerson® brand M16 (5 oz.) & M26 (10 oz.) Series Filter Assembly

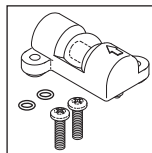

RPI Part #CMF016
OEM Part #'s - See Chart Above

AUTO DRAIN FLOAT

- Wilkerson® brand
- Includes: O-ring, nut and Adaptor Fitting (RPI Part #RPF651)
- Also available: Coalescing Filter Assembly (RPI Part #'s CMA021 & CMA022)
- Fits: Wilkerson® brand M16 (5 oz.) & M26 (10 oz.) Series Filter Assembly

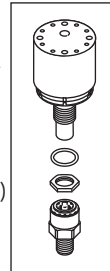

RPI Part #RPF651
OEM Part #'s - See Chart Above

ADAPTOR FITTING (3/8" TUBE X 1/8" MPT)

- Material: Acetal
- Fits: Wilkerson® brand M16 (5 oz.) & M26 (10 oz.) Series Filter Assembly



RPI Part #CMK025
OEM Part #'s - See Chart Above

COALESCING FILTER ELEMENT

- Wilkerson® (MTP-95-549)
- Size: 1.89" OD x 2.80" lg.
- Type C; 0.01 micron
- Includes all parts as shown and PM sticker
- Fits: Wilkerson® brand M26 (10 oz.) Series Filter Assembly

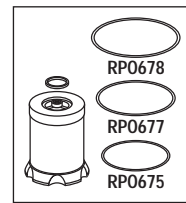

RPI Part #CMK027
OEM Part #'s - See Chart Above

COALESCING FILTER ELEMENT

- Generic brand
- Size: 1.75" OD x 2.75" lg.
- Type C; 0.01 micron
- Includes all parts as shown and PM sticker
- Fits: Wilkerson® brand M26 (10 oz.) Series Filter Assembly

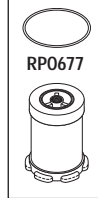

RPI Part #CMK006
OEM Part #'s - See Chart Above

COALESCING FILTER ELEMENT

- Wilkerson® (MSP-95-989)
- Size: 1.89" OD x 2.82" lg.
- Type B; 0.5 micron
- Includes: Filter Element, Seal, Bowl O-ring (RPI Part #RP0677), PM sticker, and 1 additional Bowl O-ring (RPI Part #RP0675)
- Fits: Wilkerson® brand M26 (10 oz.) Series Filter Assembly



RPI Part #CMB088
OEM Part #'s - See Chart Above

MOUNTING BRACKET

- Wilkerson® brand
- "L" type bracket; Wall mount
- Use this bracket to externally mount the Coalescing Filter Assembly to the wall.
- It's the RPI Advantage!*
- Fits: Wilkerson® brand F26 & M26 (10 oz.) Series Coalescing Filter Assemblies

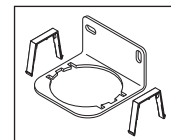

Air Techniques, Apollo/Midmark®, MDT McKesson, DentalEZ®/Custom Air/RamVac, Jun-Air, Matrix/Midmark®, Midmark®, Pelton & Crane, and Tech West/Turbine Ind.

COALESCING FILTER ASSEMBLY & REPLACEMENT PARTS

RPI PART #	DESCRIPTION	DENTALEZ®/ CUSTOM AIR/RAMVAC
CMA229	COALESCING FILTER ASSEMBLY	004960
CMB232	BOWL GASKET (AUTO DRAIN)	No OEM Part # Available
CMB262	MOUNTING BRACKET	No OEM Part # Available
CME227	COALESCING FILTER ELEMENT	005150
CMG254	BOWL GASKET	No OEM Part # Available
CM1231	DIFFERENTIAL PRESSURE INDICATOR	No OEM Part # Available

RPI Part #CMA229

OEM Part #'s - See Chart Above

COALESCING FILTER ASSEMBLY

- SMC® brand
- Includes:
 - Bowl (Auto Drain) (RPI Part #CMB232)
 - Coalescing Filter Element (RPI Part #CME227)
 - Differential Pressure Indicator (RPI Part #CM1231)
 - PM sticker
- **All parts also sold separately**

Fits: Dryer Assembly

It's the RPI Advantage! Also includes an attached PM Sticker for recording the date that the filter housing was replaced.

Also available:
Mounting Bracket
(RPI Part #CMB262)

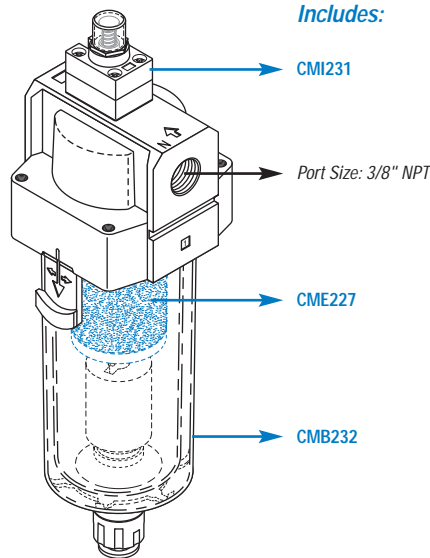
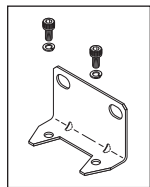

Includes:

RPI Part #CME227

OEM Part #'s - See Chart Above

COALESCING FILTER ELEMENT

- SMC® brand
- Size: 1.45" dia. x 2.78" lg.
- 0.30 Micron filter material
- Includes all parts as shown

Fits: Coalescing Filter Assembly

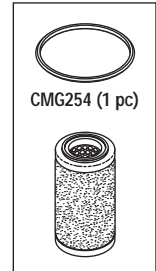

RPI Part #CMB232

OEM Part #'s - See Chart Above

BOWL (AUTO DRAIN)

- SMC® brand
- Includes: Float assembly, auto drain, and (1 pc) Bowl Gasket (RPI Part #CMG254)

Fits: Coalescing Filter Assembly

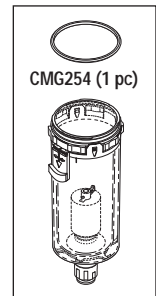

RPI Part #CM1231

OEM Part #'s - See Chart Above

DIFFERENTIAL PRESSURE INDICATOR

- SMC® brand
- Includes: Gasket and mounting screws

Fits: Coalescing Filter Assembly and Particulate Filter Assembly

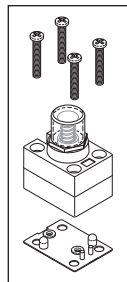

RPI Part #CMG254

OEM Part #'s - See Chart Above

BOWL GASKET

- SMC® brand
- 3 per package
- Size: 2.200" ID x 2.400" OD x .100" SQ. C/S

Fits: Dryer Assembly, Coalescing Filter Assembly and Particulate Filter Assembly

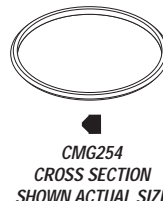

RPI Part #CMB262

OEM Part #'s - See Chart Above

MOUNTING BRACKET

- SMC® brand
 - Includes: Mounting screws (M5 x 10)
 - Use this bracket to externally mount the Coalescing Filter Assembly to the wall.
- It's the RPI Advantage!*

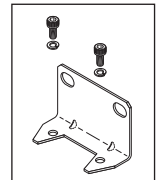

PARTICLE FILTER ASSEMBLIES & REPLACEMENT PARTS

RPI PART #	DESCRIPTION	AIR TECHNIQUES
CMA082	PARTICLE FILTER ASSEMBLY (Norgren® Brand F73) Assembly includes Particle Filter Element (RPI Part #CME083)	85617
CMA084	PARTICLE FILTER ASSEMBLY (Wilkerson® Brand F18) Assembly includes Particle Filter Element (RPI Part #CME085)	86197
CMB099	MOUNTING BRACKET (fits Norgren® Brand F73 style Filter Assys)	No OEM Part # Available
CMB100	MOUNTING BRACKET (fits Wilkerson® Brand F18 style Filter Assys)	No OEM Part # Available
CME083	PARTICLE FILTER ELEMENT (fits Norgren® Brand F73 style Filter Assys) Replacement filter (5 micron) and bowl o-ring to fit Particle Filter Assembly (RPI Part #CMA082)	85602
CME085	PARTICLE FILTER ELEMENT (fits Wilkerson® Brand F18 style Filter Assys) Replacement filter (5 micron) and bowl o-ring to fit Particle Filter Assembly (RPI Part #CMA084)	86193
CM1095	DIFFERENTIAL PRESSURE INDICATOR (Wilkerson® Brand F18) Replacement Differential Pressure Indicator to fit Particle Filter Assembly (RPI Part #CMA084)	86192
CM1096	DIFFERENTIAL PRESSURE INDICATOR (Norgren® Brand F73) Replacement Differential Pressure Indicator to fit Particle Filter Assembly (RPI Part #CMA082)	86192

RPI Part #CMA082
OEM Part #'s - See Chart Above

NORGREN® BRAND

PARTICLE FILTER ASSEMBLY

- Norgren® (F73 Series)
 - Includes:
 - Differential Pressure Indicator (RPI Part #CM1096)
 - Particle Filter Element (RPI Part #CME083)
 - PM sticker
 - **All parts also sold separately**
- Models: All Air Techniques

It's the RPI Advantage!
Also includes a PM Sticker that can be attached to the filter housing or compressor for recording the date that the filter was replaced.

Also available:
Mounting Bracket (RPI Part #CMB099)

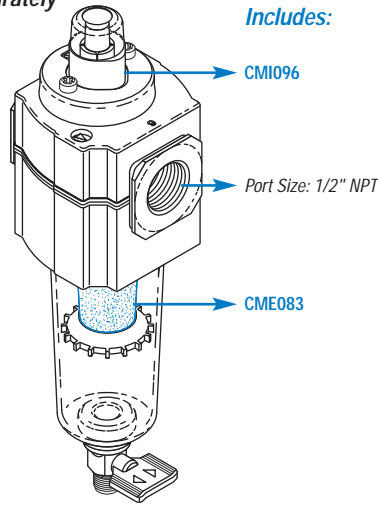

RPI Part #CME083
OEM Part #'s - See Chart Above

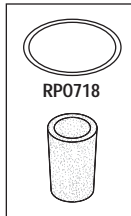

PARTICLE FILTER ELEMENT

- Norgren® brand
- Size: .93" OD x 1.44" lg.
- 5 micron filter element
- Includes all parts as shown, and PM Sticker
- Also available: Particle Filter Assembly (RPI Part #CMA082)

Fits: Norgren® brand F73 Series Particle Filter Assembly
Models: All Air Techniques

RPI Part #CM1096
OEM Part #'s - See Chart Above

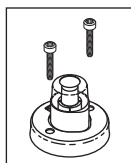

DIFFERENTIAL PRESSURE INDICATOR

- Norgren® brand
- Includes: Mounting screws
- Also available: Particle Filter Assembly (RPI Part #CMA082)

Fits: Norgren® brand F73 Series Particle Filter Assembly
Models: All Air Techniques

RPI Part #CMA084
OEM Part #'s - See Chart Above

WILKERSON® BRAND

PARTICLE FILTER ASSEMBLY

- Wilkerson® (F18 Series)
 - Includes:
 - Differential Pressure Indicator (RPI Part #CM1095)
 - Particle Filter Element (RPI Part #CME085)
 - PM sticker
 - **All parts also sold separately**
- Models: All Air Techniques

It's the RPI Advantage!
Also includes an attached PM Sticker for recording the date that the filter housing was replaced.

Also available:
Mounting Bracket (RPI Part #CMB100)

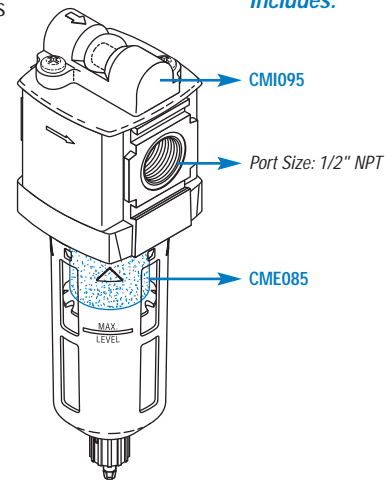

RPI Part #CME085
OEM Part #'s - See Chart Above

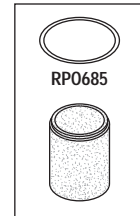

PARTICLE FILTER ELEMENT

- Wilkerson® brand
- Size: 1.30" OD x 1.62" lg.
- 5 micron filter element
- Includes all parts as shown, and PM Sticker
- Also available: Particle Filter Assembly (RPI Part #CMA084)

Fits: Wilkerson® brand B18, F18 & M18 Series Particle Filter Assembly
Models: All Air Techniques

RPI Part #CM1095
OEM Part #'s - See Chart Above

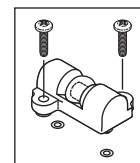

DIFFERENTIAL PRESSURE INDICATOR

- Wilkerson® brand
- Includes: Mounting screws and O-rings
- Also available: Particle Filter Assembly (RPI Part #CMA084)

Fits: Wilkerson® brand B18, F18 & M18 Series Particle Filter Assembly
Models: All Air Techniques

Air Techniques, Apollo/Midmark®, MDT McKesson, DentalEZ®/Custom Air/RamVac, Jun-Air, Matrix/Midmark®, Midmark®, Pelton & Crane, and Tech West/Turbine Ind.

PARTICULATE FILTER ASSEMBLY & REPLACEMENT PARTS

RPI PART #	DESCRIPTION	DENTAL EZ® / CUSTOM AIR/RAMVAC
CMA230	PARTICULATE FILTER ASSEMBLY	004961
CMB233	BOWL (MANUAL DRAIN)	No OEM Part # Available
CMB262	MOUNTING BRACKET	No OEM Part # Available
CME228	PARTICULATE FILTER ELEMENT	005151
CMG254	BOWL GASKET	No OEM Part # Available
CMI231	DIFFERENTIAL PRESSURE INDICATOR	No OEM Part # Available

RPI Part #CMA230

OEM Part #'s - See Chart Above

PARTICULATE FILTER ASSEMBLY

- SMC® brand
- Includes:
 - Bowl (Manual Drain) (RPI Part #CMB233)
 - Particulate Filter Element (RPI Part #CME228)
 - Differential Pressure Indicator (RPI Part #CMI231)
 - PM sticker

• **All parts also sold separately**

Fits: Dryer Assembly

It's the RPI Advantage!
Also includes an attached PM Sticker for recording the date that the filter housing was replaced.

Also available:
Mounting Bracket
(RPI Part #CMB262)

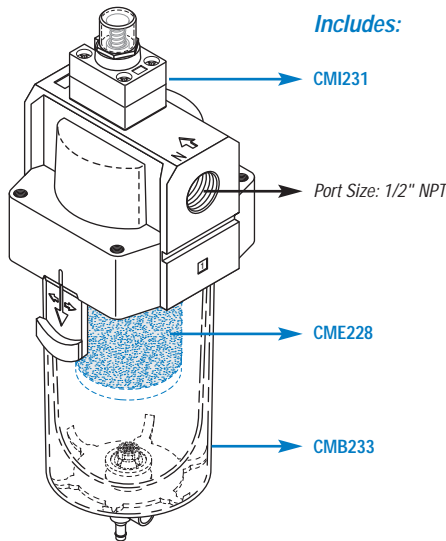
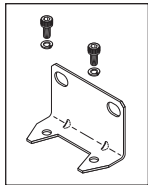

Includes:

RPI Part #CME228

OEM Part #'s - See Chart Above

PARTICULATE FILTER ELEMENT

- SMC® brand
- 0.01 Micron filter material
- Includes all parts as shown

Fits: Particulate Filter Assembly

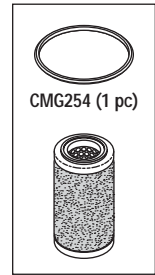

RPI Part #CMB233

OEM Part #'s - See Chart Above

BOWL (MANUAL DRAIN)

- SMC® brand
- Includes: Float assembly, manual drain, and (1 pc) Bowl Gasket (RPI Part #CMG254)

Fits: Particulate Filter Assembly

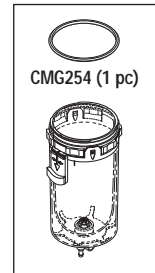

RPI Part #CMI231

OEM Part #'s - See Chart Above

DIFFERENTIAL PRESSURE INDICATOR

- SMC® brand
- Includes: Gasket and mounting screws

Fits: Coalescing Filter Assembly and Particulate Filter Assembly

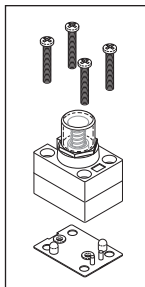

RPI Part #CMG254

OEM Part #'s - See Chart Above

BOWL GASKET

- SMC® brand
- 3 per package
- Size: 2.200" ID x 2.400" OD x .100" SQ. C/S

Fits: Dryer Assembly, Coalescing Filter Assembly and Particulate Filter Assembly

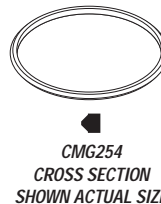

RPI Part #CMB262

OEM Part #'s - See Chart Above

MOUNTING BRACKET

- SMC® brand
- Includes: Mounting screws (M5 x 10)
- Use this bracket to externally mount the Particulate Filter Assembly to the wall.

It's the RPI Advantage!

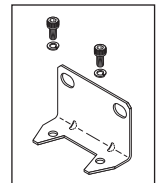

AUTO DRAINS AND FLOATS, BOWLS (AUTO & MANUAL DRAIN) & MOUNTING BRACKETS

RPI PART #	DESCRIPTION	AIR TECHNIQUES	APOLLO/ MIDMARK®	DENTAL EZ®/ CUSTOM AIR/RAMVAC	JUN-AIR	MATRX/ MIDMARK®	MIDMARK®	TECH WEST
CMB087	MOUNTING BRACKET • Fits Wilkerson® (F16 & M16 Coalescing Assemblies)	No OEM Part # Available	No OEM Part # Available			No OEM Part # Available	No OEM Part # Available	
CMB088	MOUNTING BRACKET • Fits Wilkerson® (F26 & M26 Coalescing Assemblies)	No OEM Part # Available	No OEM Part # Available			No OEM Part # Available	No OEM Part # Available	
CMB099	MOUNTING BRACKET • Fits Norgren® brand (F73 Particle Filter Assembly)	No OEM Part # Available						
CMB100	MOUNTING BRACKET • Fits Wilkerson® (B18, F18 & M18 Particle Filter Assemblies)	No OEM Part # Available						
CMB262	MOUNTING BRACKET • SMC® brand			No OEM Part # Available				
CMB232	BOWL (AUTO DRAIN)			No OEM Part # Available				
CMB233	BOWL (MANUAL DRAIN)			No OEM Part # Available				
CMD108	AUTO DRAIN FLOAT • Parker Balston® brand			JA4087602	No OEM Part # Available			
CMD111	AUTO DRAIN FLOAT • Parker Balston® brand							No OEM Part # Available
CMF016	AUTO DRAIN FLOAT Fits Wilkerson® (GRP-95-981)		ACA85210	645-45010 Wilkerson® Auto Float Drain only				

RPI Part #CMF016
OEM Part #'s - See Chart Above

- AUTO DRAIN FLOAT**
- Wilkerson® brand
 - Also available: Coalescing Filter Assembly (RPI Part #'s CMA021 & CMA022)
 - Includes: O-ring, nut and Adaptor Fitting (RPI Part #RPF651)

Fits: Wilkerson® brand M16 (5 oz.) & M26 (10 oz.) Series Filter Assembly

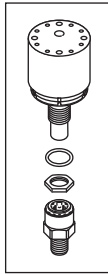

RPI Part #CMB233
OEM Part #'s - See Chart Above

- BOWL (MANUAL DRAIN)**
- SMC® brand
 - Includes all parts as shown
 - Also available: Particulate Filter Assembly (RPI Part #CMA230)

Fits: Particulate Filter Assembly

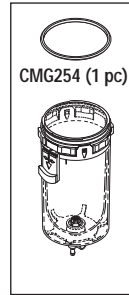

RPI Part #CMB088
OEM Part #'s - See Chart Above

- MOUNTING BRACKET**
- Wilkerson® brand
 - Wall mounting bracket
 - Black powder coated steel
 - Includes all parts as shown

Fits: Wilkerson® brand F26 & M26 Series Coalescing Filter Assemblies

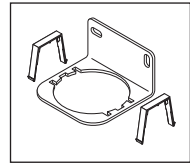

RPI Part #CMB099
OEM Part #'s - See Chart Above

- MOUNTING BRACKET**
- Norgren® brand
 - Wall mounting bracket
 - Black powder coated steel
 - Includes all parts as shown

Fits: Norgren® brand F73 Series Particle Filter Assembly

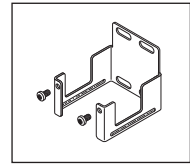

RPI Part #CMD108
OEM Part #'s - See Chart Above

- AUTO-DRAIN FLOAT**
- Parker-Balston® brand
 - Includes all parts as shown
 - Also available: Bowl O-Ring (RPI Part #RP0837)

Fits: "D" Style Absorption Dryer Assembly (Replacement Auto-Drain to fit "D" style Absorption Dryer Assembly, Coalescing Filter Assembly (Jun-Air Part #4081502))

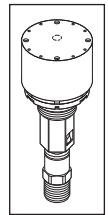

RPI Part #CMB232
OEM Part #'s - See Chart Above

- BOWL (AUTO DRAIN)**
- SMC® brand
 - Includes all parts as shown
 - Also available: Coalescing Filter Assembly (RPI Part #CMA229)

Fits: Coalescing Filter Assembly

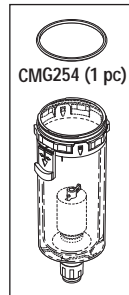

RPI Part #CMB100
OEM Part #'s - See Chart Above

- MOUNTING BRACKET**
- Wilkerson® brand
 - Wall mounting bracket
 - Black powder coated steel
 - Includes all parts as shown

Fits: Wilkerson® brand B18, F18 & M18 Series Particle Filter Assembly

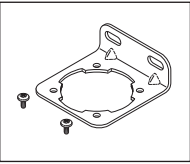

RPI Part #CMD111
OEM Part #'s - See Chart Above

- AUTO-DRAIN FLOAT**
- Parker-Balston® brand
 - Includes all parts as shown
 - Also available: Adaptor Fitting (RPI Part #RPF651) and Bowl O-Ring (RPI Part #RP0832)

Fits: Coalescing Filter Assembly (Tech West Part #CFA0-375)

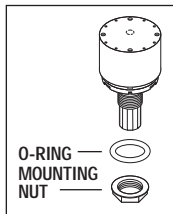

RPI Part #CMB087
OEM Part #'s - See Chart Above

- MOUNTING BRACKET**
- Wilkerson® brand
 - Wall mounting bracket
 - Black powder coated steel
 - Includes all parts as shown

Fits: Wilkerson® brand F16 & M16 Series Coalescing Filter Assemblies

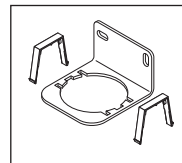

RPI Part #CMB262
OEM Part #'s - See Chart Above

- MOUNTING BRACKET**
- SMC® brand
 - Wall mounting bracket
 - Includes all parts as shown

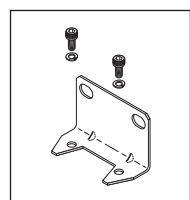

Air Techniques, Apollo/Midmark®, MDT McKesson, DentalEZ®/Custom Air/RamVac, Jun-Air, Matrix/Midmark®, Midmark®, Pelton & Crane, and Tech West/Turbine Ind.

BELTS AND BELT TOOL

RPI PART #	DESCRIPTION	APOLLO/ MIDMARK®	MIDMARK®	PELTON & CRANE
CMB279	DRIVE BELT	MMS73500	MMS73500	
PCB608	PERCHERON DRIVE BELT			006167
PCB609	WINDMILL BELT			006477
PCB610	WINDMILL BELT			011041
RPT954	BELT TENSIONER TESTER	No OEM Part # Available	No OEM Part # Available	No OEM Part # Available



Fits Scroll Style
Compressors

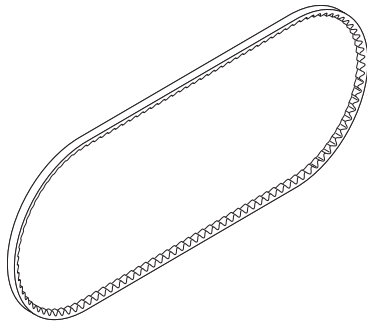

RPI Part #CMB279
OEM Part #'s - See Chart Above

DRIVE BELT

- V-Belt (3VX450)
- Effective belt length: 45.0"
- Size: .37" at top x .31" thk
- Diameter: 14.42" OD

Fits: Compressor Pulley



CMB279
CROSS SECTION
SHOWN ACTUAL SIZE



RPI Part #PCB609
OEM Part #'s - See Chart Above

WINDMILL BELT

- V-Belt (7M690)
- Effective belt length: 27.17"
- Size: .31" at top x .22" thk
- Diameter: 8.67" OD

Fits: Compressor Pulley



PCB609
CROSS SECTION
SHOWN ACTUAL SIZE

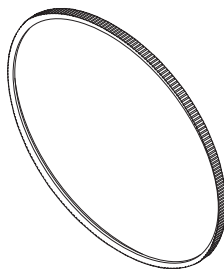

RPI Part #PCB608
OEM Part #'s - See Chart Above

PERCHERON DRIVE BELT

- V-Belt (7M900)
- Effective belt length: 35.43"
- Size: .31" at top x .22" thk
- Diameter: 11.31" OD

Fits: Compressor Pulley



PCB608
CROSS SECTION
SHOWN ACTUAL SIZE



RPI Part #PCB610
OEM Part #'s - See Chart Above

WINDMILL BELT

- V-Belt (7M730)
- Effective belt length: 28.74"
- Size: .31" at top x .22" thk
- Diameter: 9.21" OD

Fits: Compressor Pulley



PCB610
CROSS SECTION
SHOWN ACTUAL SIZE

RPI Part #RPT954
OEM Part #'s - See Chart Above

BELT TENSIONER TESTER

- Range: 0-35 lbs. (0-15.9 kg) with a span of up to 170" lg. or belt deflection of up to 2.75"
- Includes: Pocket clip and clear storage tube
- Also available: O-Ring (RPI Part #RPO302) and O-Ring (RPI Part #RPO315)

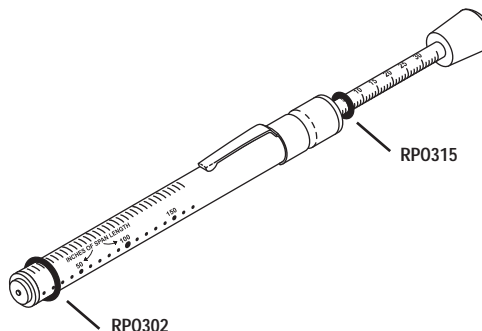

This Belt Tension Tester measures the belt tension of most "V" belts. Consult the OEM or the belt manufacturer for the recommended belt tension for each drive system.

CAPACITORS

RPI PART #	DESCRIPTION	AIR TECHNIQUES	APOLLO/MIDMARK®	DENTALEZ®/CUSTOM AIR/RAMVAC	MATRX/MIDMARK®	MIDMARK®	PELTON & CRANE	TECH WEST
CMC030	CAPACITOR (145-174µf, 250VAC)	64502	HCA30625		Included in 77001344 & 77001346	Included in 77001344 & 77001346		SCC-230
CMC031	CAPACITOR (20µf, 440VAC)	66516	HCA30622		Included in 77001346	Included in 77001346		RCC-208
CMC034	CAPACITOR (10µf, 370VAC)			Included in 645011011	Included in 77001344	Included in 77001344		
CMC036	CAPACITOR (430-516µf, 115VAC)	62502	HCA30628		Included in 77001345	Included in 77001345		SCC-115
CMC037	CAPACITOR (40µf, 370VAC)	62503	HCA30620	Included in 645011010	Included in 77001346	Included in 77001346		RCC-115
CMC042	CAPACITOR (540-648µf, 115VAC)	60502	HCA30626					
CMC201	CAPACITOR (65µf, 370VAC)	85833						
CMC202	CAPACITOR (55µf, 370VAC)	85832						
CMC203	CAPACITOR (27.5µf, 370VAC)	85831						
CMC243	CAPACITOR (460-552µf, 125VAC)	80175						
PCC636	CAPACITOR (590-708µf, 110/125VAC)						005107	

RPI Part #CMC030
OEM Part #'s - See Chart Above

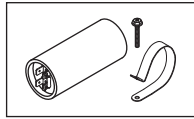

CAPACITOR (145-174µf, 250VAC)

- Motor starting
- Size: 1.81" dia x 3.38" tall
- 50/60Hz; Electrolytic
- Includes: Mounting P-clip and screw
- Also available: Start Box (RPI Part #'s CMA029, CMA033 & CMA039)

Fits: Start Box

RPI Part #CMC031
OEM Part #'s - See Chart Above

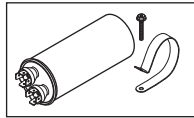

CAPACITOR (20µf, 440VAC)

- Run capacitor
- Size: 1.75" dia x 3.00/3.75" tall
- 50/60Hz.; Electrolytic
- Includes: Mounting P-clip and screw
- Also available: Start Box (RPI Part #CMA029)

Fits: Start Box

RPI Part #CMC034
OEM Part #'s - See Chart Above

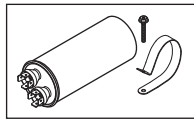

CAPACITOR (10µf, 370VAC)

- Run capacitor
- Size: 1.75" dia x 2.63"/2.17" tall
- 50/60Hz.; Electrolytic
- Includes: Mounting P-clip and screw
- Also available: Start Box (RPI Part #CMA033)

Fits: Start Box

RPI Part #CMC036
OEM Part #'s - See Chart Above

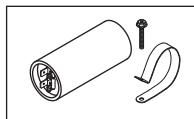

CAPACITOR (430-516µf, 115VAC)

- Motor starting
- Size: 1.81" dia x 3.38" tall
- 50/60Hz.; Electrolytic
- Includes: Mounting P-clip and screw
- Also available: Start Box (RPI Part #CMA035)

Fits: Start Box

RPI Part #CMC037
OEM Part #'s - See Chart Above

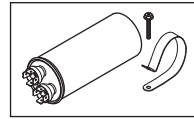

CAPACITOR (40µf, 370VAC)

- Run capacitor
- Size: 2.00" dia x 3.88" tall
- 50/60Hz.; Electrolytic
- Includes: Mounting P-clip and screw
- Also available: Start Box (RPI Part #CMA035)

Fits: Start Box

RPI Part #CMC042
OEM Part #'s - See Chart Above

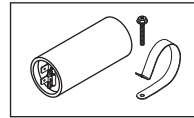

CAPACITOR (540-648µf, 115VAC)

- Motor starting
- Size: 1.81" dia x 3.38/4.38" tall
- 50/60Hz.; Electrolytic
- Includes: Mounting P-clip and screw
- Also available: Start Box (RPI Part #CMA041)

Fits: Start Box

RPI Part #CMC201
OEM Part #'s - See Chart Above

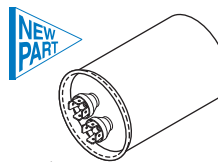

CAPACITOR (65µf, 370VAC)

- Run capacitor
- Size: 2.50" dia. x 3.00" lg.
- 50/60Hz.

Fits: Electrical Control Box

RPI Part #CMC202
OEM Part #'s - See Chart Above

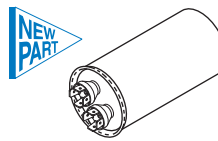

CAPACITOR (55µf, 370VAC)

- Run capacitor
- Size: 2.00" dia. x 3.75/4.31" lg.
- 50/60Hz.

Fits: Electrical Control Box

RPI Part #CMC243
OEM Part #'s - See Chart Above

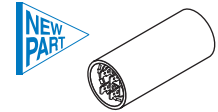

CAPACITOR (460-552µf, 125VAC)

- Start capacitor
- Size: 1.44" dia. x 3.33" lg.
- 50/60Hz.

Fits: Electrical Control Box

RPI Part #CMC203
OEM Part #'s - See Chart Above

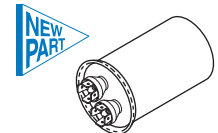

CAPACITOR (27.5µf, 370VAC)

- Run capacitor
- Size: 1.88" dia. x 3.00" lg.
- 50/60Hz.

• See **Notes** below for quantity required

Fits: Electrical Control Box

Notes: Models AirStar 30D and AirStar 30M requires (2) capacitors

RPI Part #PCC636
OEM Part #'s - See Chart Above

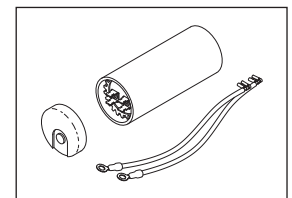

CAPACITOR (590-708µf, 110/125VAC)

- Motor starting
- Size: 1.88" dia. x 3.00" lg.
- 50/60 Hz.

• Includes: Wires set and cap

Fits: Electrical Box

Air Techniques, Apollo/Midmark®, MDT McKesson, DentalEZ®/Custom Air/RamVac, Jun-Air, Matrix/Midmark®, Midmark®, Pelton & Crane, and Tech West/Turbine Ind.

CHECK VALVES

RPI PART #	DESCRIPTION	AIR TECHNIQUES	APOLLO/MIDMARK®	DENTALEZ®/CUSTOM AIR/RAMVAC	MIDMARK®
CMK247	CHECK VALVE UPGRADE KIT	86441			
CMK248	CHECK VALVE UPGRADE KIT	86443			
CMK249	CHECK VALVE UPGRADE KIT	86447			
CMV217	CHECK VALVE	87045		004761SP	
CMV218	CHECK VALVE	85659			
CMV219	CHECK VALVE	86692			
CMV283	CHECK VALVE		PW50515		PW50515



RPI Part #CMK247
OEM Part #'s - See Chart Above

CHECK VALVE UPGRADE KIT

• Includes all parts as shown
Fits: Main Tank Assembly

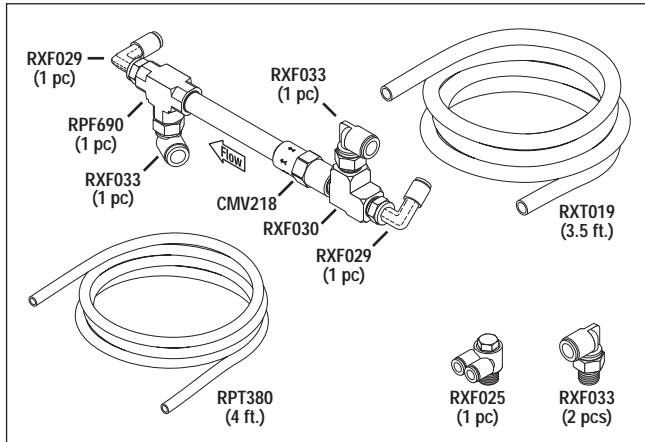

RPI Part #CMK248
OEM Part #'s - See Chart Above

CHECK VALVE UPGRADE KIT

• Includes all parts as shown
Fits: Main Tank Assembly

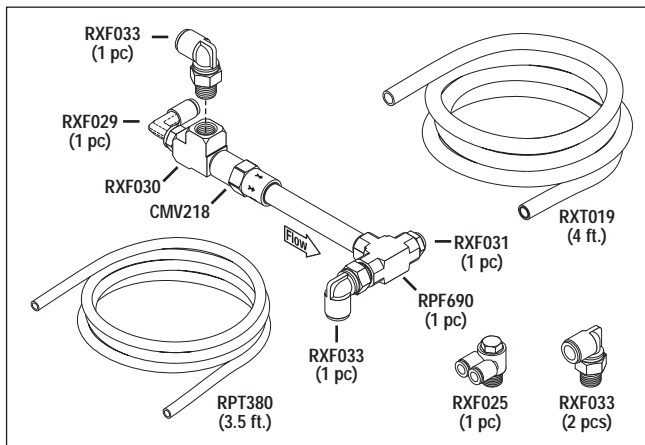

RPI Part #CMK249
OEM Part #'s - See Chart Above

CHECK VALVE UPGRADE KIT

• Includes all parts as shown
Fits: Main Tank Assembly

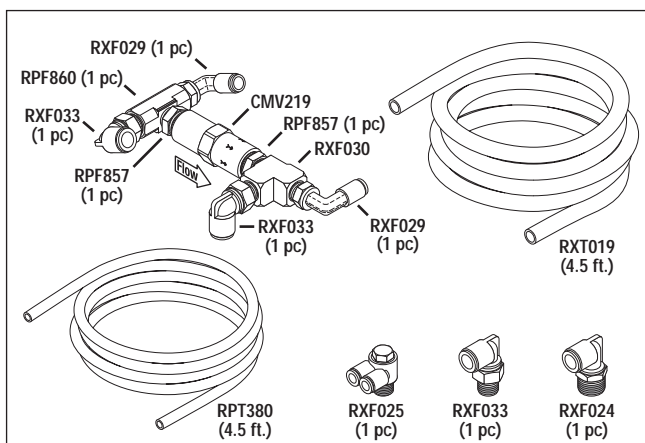

RPI Part #CMV217
OEM Part #'s - See Chart Above

CHECK VALVE

• Ports: 3/8" FPT Inlet x 3/8" MPT Outlet
• Material: Brass body; Buna-N seal
• Size: 7/8" Hex x 1.94" lg.
Fits: Manifold Assembly

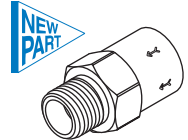

RPI Part #CMV218
OEM Part #'s - See Chart Above

CHECK VALVE

• Cracking pressure: 1-5 PSI
• Ports: 1/4" FPT inlet x 1/4" FPT outlet
• Material: Brass body, Buna-N seal
• Size: 11/16" x 1.80" lg.
• Included In: Check Valve Upgrade Kit (RPI Part #'s CMK247 & CMK248)
Fits: Manifold Assembly

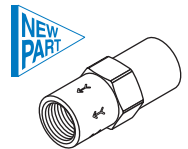

RPI Part #CMV219
OEM Part #'s - See Chart Above

CHECK VALVE

• Cracking pressure: 1.0 PSI
• Ports: 3/8" FPT inlet x 3/8" FPT outlet
• Material: Brass body, Buna-N seal
• Size: 7.8" x 2-1/4" lg.
• Included In: Check Valve Upgrade Kit (RPI Part #CMK249)
Fits: Manifold Assembly

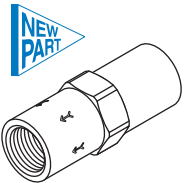

RPI Part #CMV283
OEM Part #'s - See Chart Above

CHECK VALVE

• Cracking Pressure: 1-5 PSI
• Ports: 3/8" MPT Inlet x 3/8" MPT Outlet
• Material: Brass Body; Buna-N Seal
• Size: 11/16" Hex x 1.70" lg.
Fits: Cluster Assembly

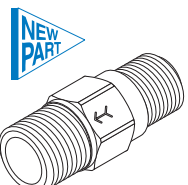

COOLING FANS & ACCESSORIES

RPI PART #	DESCRIPTION	AIR TECHNIQUES	APOLLO MIDMARK®	DENTAL EZ®/ CUSTOM AIR/RAMVAC	JUN-AIR	MDT McKESSON	MIDMARK®	TECH WEST
CMF019	COOLING FAN (115V)	41060	SEA95535	5451400	JAS445100 Cooling Fan only	3-08-0578-10	65995000	CF-115 Cooling Fan only
CMF020	COOLING FAN (230V)	80516	SEA95540	5451500	JAS445000 Cooling Fan only	3-08-0563-10	EM510305	CF-230 Cooling Fan only
RPC822	SOUND DAMPING COMPOSITE	No OEM Part # Available	No OEM Part # Available	No OEM Part # Available	No OEM Part # Available	No OEM Part # Available	No OEM Part # Available	No OEM Part # Available

RPI Part #CMF019
OEM Part #'s - See Chart Above

COOLING FAN (115VAC)

- Size: 4-11/16" x 4-11/16" x 1-1/2"
- Includes: mounting hardware
- Aluminum housing; Ball bearing

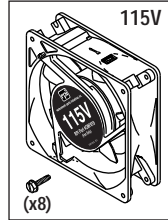

RPI Part #CMF020
OEM Part #'s - See Chart Above

COOLING FAN (230VAC)

- Size: 4-11/16" x 4-11/16" x 1-1/2"
- Includes: mounting hardware
- Aluminum housing; Ball bearing

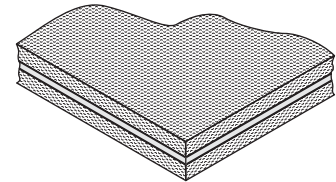
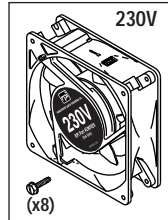

RPI Part #RPC822
OEM Part #'s - See Chart Above

SOUND DAMPING COMPOSITE

- Size: 12" x 12" x 1/2" thk.
- Acoustic foam with vinyl barrier core and adhesive backing; Cut to size

Fits: Dental Compressor Sound Covers including: Midmark® OEM Part #'s 77001603, 77001604, 77001605, & 77001606 and Apollo/Midmark OEM Part #'s ACA70620, ACA70621, ACA70622, ACA70700, ACA70705, ACA70710 & ACA70715

MOISTURE INDICATORS

RPI PART #	DESCRIPTION	AIR TECHNIQUES	APOLLO/MIDMARK®	DENTAL EZ®/ CUSTOM AIR/RAMVAC	MATRX/MIDMARK®	MDT McKESSON	TECH WEST
CMI077	MOISTURE INDICATOR	60013	ACA86965				
CMI078	MOISTURE INDICATOR			004021			MI-100
CMI079	MOISTURE INDICATOR				77005140		
CMI081	MOISTURE INDICATOR					3-08-1019-20	
RPT579	1/4" TEFLON THREAD SEALING TAPE	No OEM Part # Available	No OEM Part # Available	No OEM Part # Available	No OEM Part # Available	No OEM Part # Available	No OEM Part # Available

RPI Part #CMI077
OEM Part #'s - See Chart Above

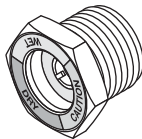

MOISTURE INDICATOR

- Zinc plated steel
- Size: 15/16" HEX x 1/2" MPT
- Glass window
- Easy to read color changing legend and indicator: Blue to Pink

Fits: Manifold Block Assembly

RPI Part #CMI078
OEM Part #'s - See Chart Above

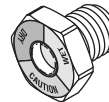

MOISTURE INDICATOR

- Zinc plated steel
- 1/4" MPT
- Glass window
- Easy to read color changing legend and indicator: Blue to Pink

Fits: Manifold Block Assembly

RPI Part #CMI079
OEM Part #'s - See Chart Above

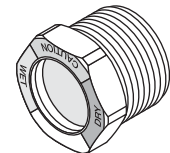

MOISTURE INDICATOR

- Zinc plated steel
- 3/4" MPT
- Glass window
- Easy to read color changing legend and indicator: Blue to Pink

Fits: Manifold Block Assembly

RPI Part #CMI081
OEM Part #'s - See Chart Above

MOISTURE INDICATOR

- Zinc plated steel
- 15/16-20 threads; Includes O-ring seal
- Glass window
- Easy to read color changing legend and indicator: Blue to Pink

Fits: Manifold Block Assembly

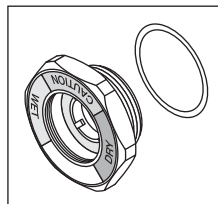

RPI Part #RPT579
OEM Part #'s - See Chart Above

1/4" TEFLON THREAD SEALING TAPE

- 5 per package
- 1/4" x 260" per unit

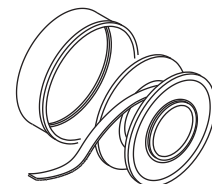

Air Techniques, Apollo/Midmark®, MDT McKesson, DentalEZ®/Custom Air/RamVac, Jun-Air, MatrX/Midmark®, Midmark®, Pelton & Crane, and Tech West/Turbine Ind.

DESICCANTS & DESICCANT TANK FILTERS

RPI PART #	DESCRIPTION	AIR TECHNIQUES	APOLLO/MIDMARK®	MATR/MIDMARK®	MIDMARK®	TECH WEST
CMD091	DESICCANT - See part description below for quantity required	60010	RAM80105			
CMD093	DESICCANT - See part description below for quantity required		RAM80100			MDS-200
CMD094	DESICCANT - See part description below for quantity required	80069				MDS-100
CMF127	CONE FILTER	60097				
CMF129	DESICCANT TANK FILTER		PFM70301	PFM70301	PFM70301	AS-500
CMF130	DESICCANT TANK FILTER		PFM70300	PFM70300	PFM70300	

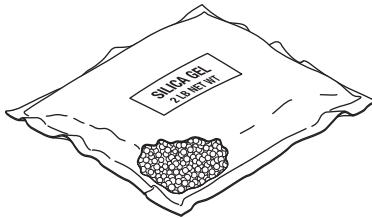

RPI Part #CMD091
OEM Part #'s - See Chart Above

DESICCANT

- Sold in 2 lb. bag
- Air Techniques OEM Part #60010 requires 5 lbs.; Apollo/Midmark OEM Part #RAM80105 requires 14 lbs.
- Material: Grade 20 G Silica Gel
- Also available: Cone Filter (RPI Part #CMF127), Desiccant Tank Filter (RPI Part #CMF129) and Desiccant Tank Filter (RPI Part #CMF130)

Fits: Desiccant Tank

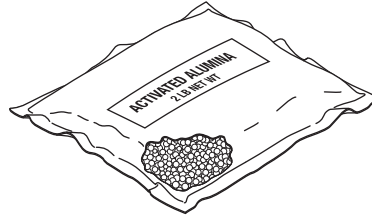

RPI Part #CMD093
OEM Part #'s - See Chart Above

DESICCANT

- Sold in 2 lb. bag
- Apollo/Midmark OEM Part #RAM80105 requires 2 lbs.; Tech West OEM Part #MDS-200 requires 2 lbs.
- Material: Activated Alumina
- Also available: Desiccant Tank Filter (RPI Part #CMF129) and Desiccant Tank Filter (RPI Part #CMF130)

Fits: Desiccant Tank

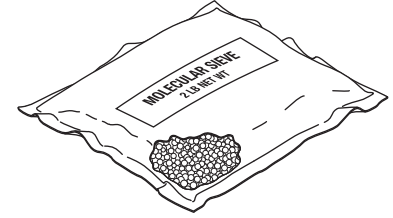

RPI Part #CMD094
OEM Part #'s - See Chart Above

DESICCANT

- Sold in 2 lb. bag
- Air Techniques OEM Part #80069 requires 0.5 lb.; Tech West OEM Part #MDS-100 requires 2 lbs.
- Material: Molecular Sieve
- Also available: Desiccant Tank Filter (RPI Part #CMF129) and Desiccant Tank Filter (RPI Part #CMF130)

Fits: Desiccant Tank

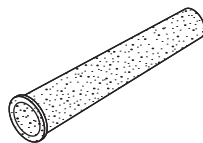

RPI Part #CMF127
OEM Part #'s - See Chart Above

CONE FILTER

- Material: Sintered bronze
- Size: .86" dia. x 4.00" lg.
- Also available: Desiccant (Grade 20 G Silica Gel) (RPI Part #CMD091)

Fits: Drying Chamber

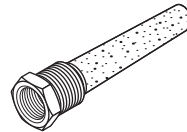

RPI Part #CMF129
OEM Part #'s - See Chart Above

DESICCANT TANK FILTER

- Material: Sintered bronze
- Size: 7/8" hex x 3.62" lg.
- 3/8" FPT x 1/2" MPT brass adaptor
- Also available: Desiccant (Grade 20 G Silica Gel) (RPI Part #CMD091), Desiccant (Activated Alumina) (RPI Part #CMD093) and Desiccant (Molecular Sieve) (RPI Part #CMD094)

Fits: Drying Chamber

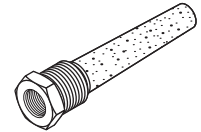

RPI Part #CMF130
OEM Part #'s - See Chart Above

DESICCANT TANK FILTER

- Material: Sintered bronze
- Size: 7/8" hex x 3.62" lg.
- 1/4" FPT x 1/2" MPT brass adaptor
- Also available: Desiccant (Grade 20 G Silica Gel) (RPI Part #CMD091), Desiccant (Activated Alumina) (RPI Part #CMD093) and Desiccant (Molecular Sieve) (RPI Part #CMD094)

Fits: Drying Chamber

DRYERS

RPI Part #CMD234
OEM Part #004018SP

DRYER

- 2 per package
- Size: 12.34" lg. x 2.00" OD
- Includes: (2 pcs) Viton® O-rings (RPI Part #RX0100), and PM Sticker
- It is recommended that this dryer be replaced every 5 years
- **Notes:** There are two dryers per assembly.

Fits: Dryer Assembly

Models: Osprey 13, Osprey 22 & Osprey 23

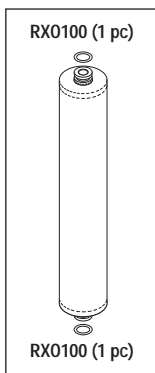

It's the RPI Advantage! Also includes an attached PM Sticker for recording the date that the dryer was replaced.

RPI Part #CMD236
OEM Part #005413SP

DRYER

- 2 per package
- Size: 15.50" lg. x 3.00" OD
- Includes: (2 pcs) Viton® O-rings (RPI Part #RX0100), and PM Sticker
- It is recommended that this dryer be replaced every 5 years
- **Notes:** There are two dryers per assembly.

Fits: Dryer Assembly

Models: Osprey 28

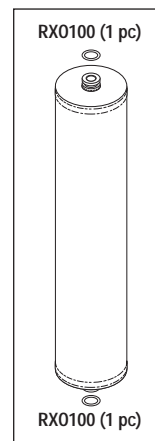

It's the RPI Advantage! Also includes an attached PM Sticker for recording the date that the dryer was replaced.

RPI Part #CMD235
OEM Part #004020SP

DRYER

- 2 per package
- Size: 14.25" lg. x 2.52" OD
- Includes: (2 pcs) Viton® O-rings (RPI Part #RX0100), and PM Sticker
- It is recommended that this dryer be replaced every 5 years
- **Notes:** There are two dryers per assembly.

Fits: Dryer Assembly

Models: Osprey 24 & Osprey 25

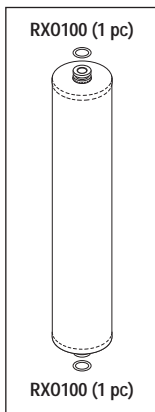

It's the RPI Advantage! Also includes an attached PM Sticker for recording the date that the dryer was replaced.

RPI Part #RX0100
OEM Part # (No OEM Part # Available)

O-RING

- 6 per package
- Size: .549" ID x .755" OD x .103" C/S
- Material: Viton®; 75 Duro
- Included in: Dryer (RPI Part #CMD234), Dryer (RPI Part #CMD235), Dryer (RPI Part #CMD236)

Fits: Dryer Assembly

Models: Osprey 13, Osprey 22 & Osprey 23, Osprey 24, Osprey 25 & Osprey 28

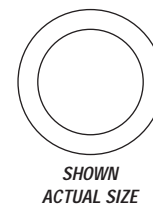

INLET & OUTLET SHUTTLE DISKS

RPI Part #CMD239
OEM Part # (No OEM Part # Available)

OUTLET SHUTTLE DISK

- Material: Teflon®
 - Size: .57" OD dia x .25" thk; 0.037" orifice
- Fits:** Dryer Assembly
Models: Osprey 13, Osprey 22 & Osprey 23

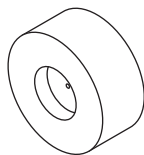

RPI Part #CMD241
OEM Part # (No OEM Part # Available)

OUTLET SHUTTLE DISK

- Material: Teflon®
 - Size: .57" OD x .25" thk; 0.064" orifice
- Fits:** Dryer Assembly
Models: Osprey 28

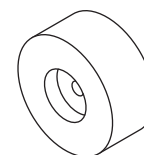

RPI Part #CMD240
OEM Part # (No OEM Part # Available)

OUTLET SHUTTLE DISK

- Material: Teflon®
 - Size: .57" OD x .25" thk; 0.053" orifice
- Fits:** Dryer Assembly
Models: Osprey 24 & Osprey 25

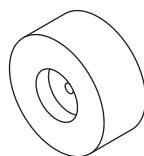

RPI Part #CMD242
OEM Part # (No OEM Part # Available)

INLET SHUTTLE DISK

- Material: Teflon®
 - Size: .57" OD x .25" thk
- Fits:** Dryer Assembly
Models: Osprey 13, Osprey 22 & Osprey 23, Osprey 24, Osprey 25 & Osprey 28

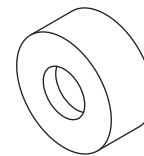

Air Techniques, Apollo/Midmark®, MDT McKesson, DentalEZ®/Custom Air/RamVac, Jun-Air, Matrix/Midmark®, Midmark®, Pelton & Crane, and Tech West/Turbine Ind.

COMPRESSOR HEAD COMPONENT

RPI PART #	DESCRIPTION	APOLLO/MIDMARK®	DENTALEZ® CUSTOM AIR/RAMVAC	JUN-AIR	MIDMARK®	PELTON & CRANE
CMG197	DRAIN PLUG GASKET - 3/PKG		JA6235000	6235000		
CMK287	COMPRESSOR TIP SEAL KIT	HPA30505			HPA30505	
CMP196	OIL PLUG		JA7167000	7167000		
PCG627	GASKET (MUFFLER)					005040
PCG628	GASKET (CYLINDER HEAD)					004924
PCG629	GASKET (VALVE PLATE)					004925
PCG630	GASKET (OIL PAN)					004929
PCG631	GASKET (END COVER)					004930
PCP637	SPRING PAD					004877
PCS638	SPRING					005070
PCV640	VALVE PLATE ASSEMBLY					004976
RP0848	O-RING (RIB COVER GASKET)		JA6244000	6244000		

RPI Part #CMP196
OEM Part #'s - See Chart Above

OIL PLUG

- Material: Nickel plated brass
- 3/8-19 BSPP
- Includes all parts as shown
- Fits: Ribbed Cover

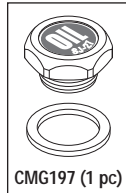

RPI Part #CMG197
OEM Part #'s - See Chart Above

DRAIN PLUG GASKET

- 3 per package
- Material: Fiber
- Size: .668" ID x .889" OD x .066" thk
- Included in: Oil Plug (RPI Part #CMP196) Compressor PM Kits (see page 400)
- Fits: Oil Plug



RPI Part #PCG627
OEM Part #'s - See Chart Above

GASKET (MUFFLER)

- 3 per package
- Fits: Head Assembly

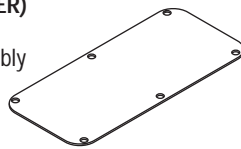

RPI Part #PCG628
OEM Part #'s - See Chart Above

GASKET (CYLINDER HEAD)

- 3 per package
- Fits: Head Assembly

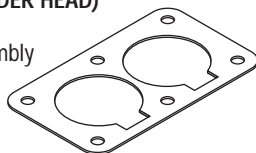

RPI Part #PCG629
OEM Part #'s - See Chart Above

GASKET (VALVE PLATE)

- 3 per package
- Fits: Head Assembly

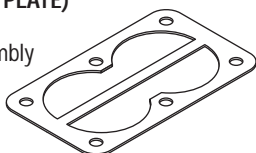

RPI Part #PCG630
OEM Part #'s - See Chart Above

GASKET (OIL PAN)

- Fits: Oil Pan

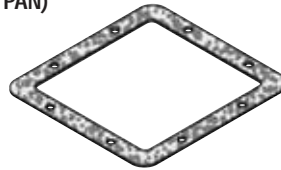

RPI Part #PCG631
OEM Part #'s - See Chart Above

GASKET (END COVER)

- 3 per package
- Fits: End Cover

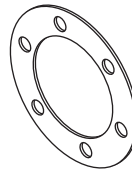

RPI Part #PCP637
OEM Part #'s - See Chart Above

SPRING PAD

- 12 per package
- Material: Buna N;
- Color: Black
- Fits: Mounting Spring



RPI Part #PCS638
OEM Part #'s - See Chart Above

SPRING

- 12 per package
- Fits: Motor Housing



RPI Part #PCV640
OEM Part #'s - See Chart Above

VALVE PLATE ASSEMBLY

- Fits: Head Assembly

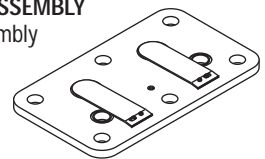

RPI Part #RP0848
OEM Part #'s - See Chart Above

O-RING (RIB COVER GASKET)

- Material: Nitrile (Buna N)
- Size: 176mm ID x 182mm OD x 3mm C/S
- Included in: Compressor PM Kits (see page 400)
- Fits: Ribbed Cover of the Jun-Air M6 Motors

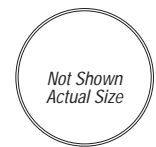

RPI Part #CMK287
OEM Part #'s - See Chart Above

COMPRESSOR TIP SEAL KIT

- For oil-less single headed, belt driven compressors
- OEM recommends replacement every 5,000 hours
- Includes all parts as shown including Grease Cartridge (RPI Part #RXG070, O-Ring Removal Tool (RPI Part #RXT002), and PM Sticker
- Included in: Air Intake Upgrade Kit (RPI Part #CMK280) Belt Tension Tester (RPI Part #RPT954) Compressor PM Kit (RPI Part #CMK274) Compressor PM & Tip Seal Kit (RPI Part #CMK286) Drive Belt (RPI Part #CMB279), and Grease Gun Kit (RPI Part #RXK069)
- Fits: Compressor Head

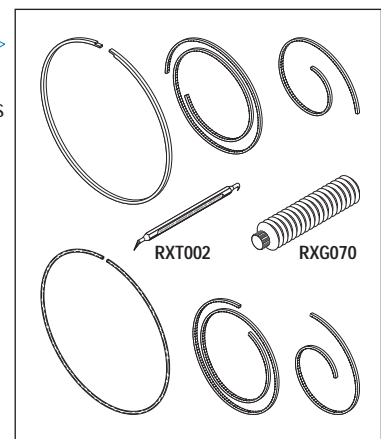

Air Techniques, Apollo/Midmark®, DCI/MDT McKesson, DentalEZ®/Custom Air/RamVac, Jun-Air, Matrix/Midmark®, Midmark®, Pelton & Crane, and Tech West/Turbine Industries
 DENTAL COMPRESSORS - SECTION 4 PAGE 419 UPDATED 01/20

DIFFERENTIAL PRESSURE INDICATORS

RPI PART #	DESCRIPTION	AIR TECHNIQUES	APOLLO/MIDMARK®	DENTAL EZ®/CUSTOM AIR/RAMVAC	JUN-AIR	MATRIX/MIDMARK®	MIDMARK®	TECH WEST
CMC086	BLANK COVER	No OEM Part # Available	No OEM Part # Available	No OEM Part # Available	No OEM Part # Available	No OEM Part # Available	No OEM Part # Available	No OEM Part # Available
CMI015	DIFFERENTIAL PRESSURE INDICATOR (WILKERSON® Part #DP2-01-000)		AAP85210			77002134	65907600	CI-100
CMI095	DIFFERENTIAL PRESSURE INDICATOR (Wilkerson® Brand)	86192						
CMI096	DIFFERENTIAL PRESSURE INDICATOR (Norgren Brand F73)	86192						
CMI231	DIFFERENTIAL PRESSURE INDICATOR			No OEM Part # Available				
CMK216	PRESSURE INDICATOR BYPASS KIT			No OEM Part # Available	No OEM Part # Available			

RPI Part #CMC086
OEM Part #'s - See Chart Above

BLANK COVER

- Wilkerson® brand
 - Black plastic
 - Includes all parts as shown
 - Replaces Differential Pressure Indicator (RPI Part #CMI015)
 - Also available: Coalescing Filter Assembly (RPI Part #'s CMA021 & CMA022)
- Fits:** Wilkerson® brand M16 (5 oz.) & M26 (10 oz.) Series Coalescing Filter Assembly

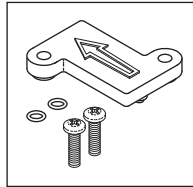

RPI Part #CMI095
OEM Part #'s - See Chart Above

DIFFERENTIAL PRESSURE INDICATOR

- Wilkerson® brand
 - Includes: Mounting screws and O-rings
 - Also available: Particle Filter Assembly (RPI Part #CMA084)
- Fits:** Wilkerson® brand B18, F18 & M18 Series Particle Filter Assembly

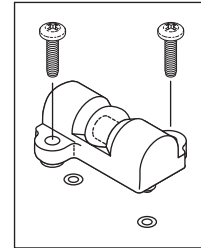

RPI Part #CMI015
OEM Part #'s - See Chart Above

DIFFERENTIAL PRESSURE INDICATOR

- Wilkerson® brand
 - Includes: Screws and O-rings
 - Also available: Coalescing Filter Assembly (RPI Part #'s CMA021 & CMA022)
- Fits:** Wilkerson® brand M16 (5 oz.) & M26 (10 oz.) Series Coalescing Filter Assembly

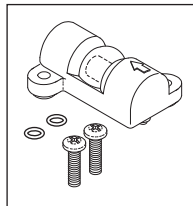

RPI Part #CMI231
OEM Part #'s - See Chart Above

DIFFERENTIAL PRESSURE INDICATOR

- SMC® brand
 - Includes: Gasket and mounting screws
 - Also available: Coalescing Filter Assembly (RPI Part #'s CMA229) and Particulate Filter Assembly (RPI Part #CMA230)
- Fits:** Coalescing Filter Assembly and Particulate Filter Assembly

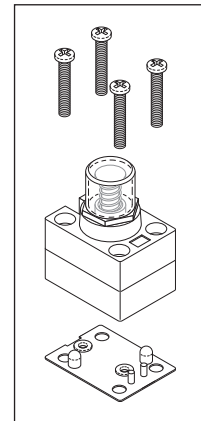

RPI Part #CMI096
OEM Part #'s - See Chart Above

DIFFERENTIAL PRESSURE INDICATOR

- Norgren® brand
 - Includes: Mounting screws
 - Also available: Particle Filter Assembly (RPI Part #CMA082)
- Fits:** Norgren® brand F73 Series Particle Filter Assembly

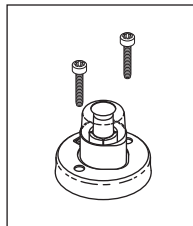

RPI Part #CMK216
OEM Part #'s - See Chart Above

BLANKING KIT

- Material: Stainless steel screws and Nylon® washers
 - Includes all parts as shown
 - Replaces **discontinued** Differential Pressure Indicator (RPI Part #CMI106)
- Fits:** Coalescing Filter Assembly on the Dryer "DH" Series

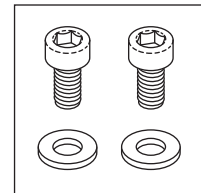

Air Techniques, Apollo/Midmark®, MDT McKesson, DentalEZ®/Custom Air/RamVac, Jun-Air, Matrix/Midmark®, Midmark®, Pelton & Crane, and Tech West/Turbine Ind.

FILTERS - AIR INTAKE FILTERS & ELEMENTS

RPI PART #	DESCRIPTION	AIR TECHNIQUES	APOLLO/MIDMARK®	DENTALEZ®/CUSTOM AIR/JUN-AIR/RAMVAC	MATRIX/MIDMARK®	MIDMARK®
CME004	REPLACEMENT FILTER ELEMENT		Fits RPI Part #CMK003 only			Fits RPI Part #CMK003 only
CME071	AIR FILTER ELEMENT				77001541	77001541
CMF073	AIR INTAKE FILTER			JA5413210		
CMK003	FRESH AIR INTAKE FILTER KIT		PFM50955		ACP90505	ACP90505
CMK065	AIR FILTER ELEMENT KIT	89938 & 89831				

RPI Part #CMK003

OEM Part #'s - See Chart Above

FRESH AIR INTAKE FILTER KIT

- Can also be used for air intake systems
- Includes: Filter Housing, (2 pc) Uniclamp (RPI Part #RPC442), Tubing (.50" ID x .73" OD Clear/Braided - sold by the foot) (RPI Part #RPT441), (1 pc) Cap (RPI Part #RPC443), (1 pc) Adaptor (1/4" MPT x 1/4" MPT) (RPI Part #RPF833), Replacement Filter Element (RPI Part #CME004), and PM sticker

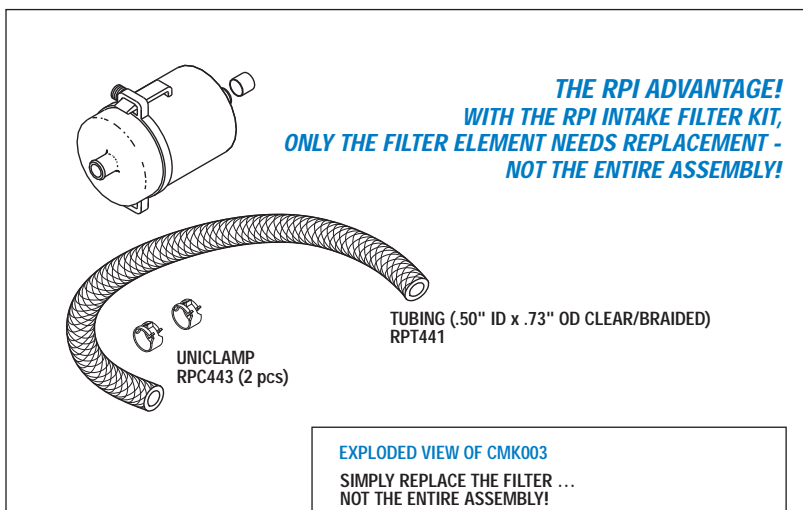

It's the RPI Advantage! Also includes a PM Sticker that can be attached to the filter housing for recording the date that the filter element was replaced.

RPI Part #CME004

OEM Part #'s - Fits RPI Part #CMK003 only

REPLACEMENT FILTER ELEMENT

- Can also be used for air intake systems
- Replacement filter element for Fresh Air Intake Filter Kit (RPI Part #CMK003) **only**
- Includes: O-ring, and PM sticker
- Size: 1.56" OD x 2.96" lg.

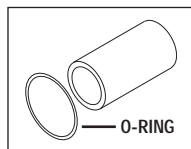

RPI Part #CMK065

OEM Part #'s - See Chart Above

AIR FILTER ELEMENT KIT

- 10 micron paper filter
- Size: 1.25" OD x 3.77" lg.
- Includes: Elbow barb fitting, and PM sticker
- Can be used with a Fresh Air Intake System
- See **Note 1** below for quantity required for each model

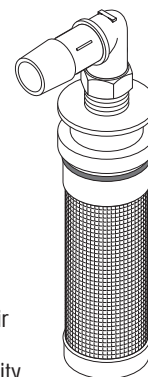

RPI Part #CME071

OEM Part #'s - See Chart Above

AIR FILTER ELEMENT

- Size: 1.38" OD x 3.43" lg.
- Used for Fresh Air intake
- Includes: Rubber Air Filter Cap, and PM sticker
- Can be used for Fresh Air intake
- See **Note 2** below for quantity required for each model

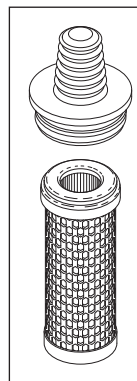

Fits: Compressor heads

RPI Part #CMF073

OEM Part #'s - See Chart Above

AIR INTAKE FILTER

- 5 micron polyester filter
- Size: 1.58" OD x 2.39" lg. plastic housing
- Can be used for Fresh Air intake
- Includes: 10.50" of .38" OD clear tubing, and PM sticker
- See **Note 3** below for quantity required for each model

Fits: Compressor Head Assembly

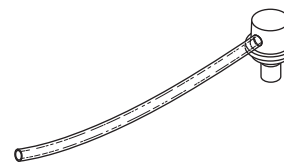

Note 1: Air Techniques: AirStar® 1 & 10 requires (1); AirStar® 2-1, 2-2, 3, 21, 22 & 30 requires (2); AirStar® 5 & 50 requires (4); AirStar® 7 & 70 requires (6), and AirStar® 100M requires (8).

Note 2: Matrix: OL-3, OL-2000 & OL-2001 requires (2); OL-7 & OL-4000 requires (4); and OL-10 & OL-6000 requires (6). Midmark: P52 requires (4) and P72 requires (6).

Note 3: DentalEZ/Custom Air/Jun-Air/RamVac: CA-711 & CA721 require (1); CA-713 & CA-723 requires (2); CA-813-D & CA-823-D (Serial #440537 and below) requires (2); and CA-725 requires (4).

FILTERS - AIR INTAKE FILTERS & ELEMENTS (continued)

RPI PART #	DESCRIPTION	AIR TECHNIQUES	APOLLO/MIDMARK®	DENTAL EZ®/CUSTOM AIR/RAMVAC	JUN-AIR	MATR X/MIDMARK®	MDT MCKESSON	TECH WEST
CMA068	AIR FILTER ASSEMBLY							TAF-100
CMA070	AIR FILTER ASSEMBLY							TAF-200
CMA072	AIR FILTER ASSEMBLY			004006				
CME067	AIR FILTER ELEMENT			003965				TIF-100
CME069	AIR FILTER ELEMENT							TIF-200
CME074	INTAKE FILTER ELEMENT			JA5412500	JA5412500			
CME080	AIR FILTER ELEMENT			003965				
CMF002	AIR INTAKE FILTER	80050	PFM50955					
CMF011	FOAM ELEMENT	60043-1						
CMF013	FOAM ELEMENT					7700709		AAF-100
CMF014	FOAM ELEMENT						3-08-0632-10	
CMF075	INTAKE FILTER			JA5412400	JA5412400			

RPI Part #CMA068
OEM Part #'s - See Chart Above

AIR FILTER ASSEMBLY

- Size: 2.45" OD x 3.17" H
 - Ports: 3/8" NPSC Female inlet x 1/4" MPT outlet
 - Includes: Air Filter Element (RPI Part #CME067)
 - Can be used with a Fresh Air Intake System
 - See **Note 1** below for required quantity for each model
- Fits:** 1 HP Compressor Head

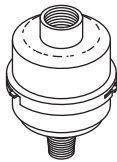

RPI Part #CMA072
OEM Part #'s - See Chart Above

AIR FILTER ASSEMBLY

- Size: 2.45" OD x 3.17" H
 - Ports: 3/8" NPSC Female inlet x 3/8" MPT outlet
 - Includes: Air Filter Element (RPI Part #CME080)
 - Can be used with a Fresh Air Intake System
- Fits:** 1 HP Compressor Head

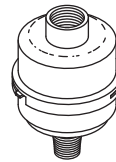

RPI Part #CMF011
OEM Part #'s - See Chart Above

FOAM ELEMENT

- Size: 4.25" OD x 2.00" lg.

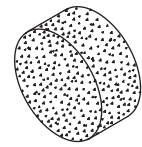

RPI Part #CME067
OEM Part #'s - See Chart Above

AIR FILTER ELEMENT

- 2 micron paper filter
 - Size: 2.25" OD x 1.00" H
 - See **Note 1** below for required quantity for each model
- Fits:** Air Filter Assembly



RPI Part #CME080
OEM Part #'s - See Chart Above

AIR FILTER ELEMENT

- 25 micron polyester filter
 - Size: 2.25" OD x 1.00" H
- Fits:** Air Filter Assembly

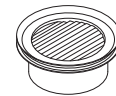

RPI Part #CMF013
OEM Part #'s - See Chart Above

FOAM ELEMENT

- Size: 2.00" OD x 2.00" lg.

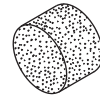

RPI Part #CMA070
OEM Part #'s - See Chart Above

AIR FILTER ASSEMBLY

- Size: 3.20" OD x 3.96" H
 - Ports: 3/8" NPSC Female inlet x 1/4" MPT outlet
 - Includes: Air Filter Element (RPI Part #CME069)
 - Can be used with a Fresh Air Intake System
- Fits:** 2 HP Compressor Head

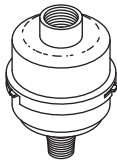

RPI Part #CME074
OEM Part #'s - See Chart Above

INTAKE FILTER ELEMENT

- Size: 1.36" OD x 3.28" lg.
- 5 micron paper filter
- See **Note 2** below for required quantity for each model

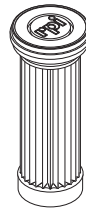

RPI Part #CMF014
OEM Part #'s - See Chart Above

FOAM ELEMENT

- Size: 2.50" OD x 4.50" lg.

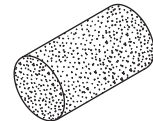

RPI Part #CME069
OEM Part #'s - See Chart Above

AIR FILTER ELEMENT

- 2 micron paper filter
 - Size: 3.00" OD x 1.38" H
- Fits:** Air Filter Assembly



RPI Part #CMF002
OEM Part #'s - See Chart Above

AIR INTAKE FILTER (METAL STYLE)

- Size: 1.84" OD x 3.63" lg.
- Port: 1/4" MPT
- Auto Muffler MO2

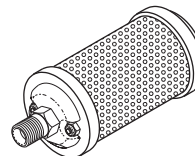

RPI Part #CMF075
OEM Part #'s - See Chart Above

INTAKE FILTER

- Size: 1.04" OD x 2.38" lg.
- 5 micron polyester filter
- 1 per package - each unit requires (2)
- Can be used with a Fresh Air Intake System



Note 1: DentalEZ/Custom Air/RamVac: 1013D requires (2), 1022 requires (1), 1023D requires (2), 1025D requires (2), 1027D requires (2) & 1029T requires (3). Tech West: ACL2S1/ND, ACL2S2/ND & ACL4D2/ND (2005 and earlier) requires (1); ACL2S1, ACL2S2 & ACL4D2 (2006 and later) requires (1); AC02S1/ND & AC02S2/ND requires (2); AC04S2/ND (2005 and earlier) and AC04D2/ND requires (4); AC06T2/ND requires (6).

Note 2: Jun-Air: CA-812, CA-822, CA-912 & CA-922 requires (1); CA-825/D/Q, CA-925/D requires (2); CA-827-D & CA-927-D requires (3); CA-829-D & CA-929-D requires (4); and CA-8212-T requires (6).

Air Techniques, Apollo/Midmark®, MDT McKesson, DentalEZ®/Custom Air/RamVac, Jun-Air, Matrix/Midmark®, Midmark®, Pelton & Crane, and Tech West/Turbine Ind.

FILTERS - AIR INTAKE FILTERS & ELEMENTS (continued)

RPI PART #	DESCRIPTION	APOLLO/ MIDMARK®	MIDMARK®	PELTON & CRANE
CMA289	AIR FILTER ASSEMBLY	No OEM Part # Available	No OEM Part # Available	
CME281	AIR INTAKE FILTER ELEMENT	PFM50950 (rectangular style)	PFM50950 (rectangular style)	
CME288	AIR FILTER ELEMENT	No OEM Part # Available		No OEM Part # Available
CMF282	AIR INTAKE FILTER	No OEM Part # Available		No OEM Part # Available
CMK280	AIR INTAKE UPGRADE KIT	PFM50950 (rectangular style)	PFM50950 (rectangular style)	
PCC626	FILTER CAP (AIR INLET)			005097
PCF625	FILTER (FELT)			005031
PCS624	FILTER SCREEN			005044

NEW PART
Fits Scroll Style Compressors

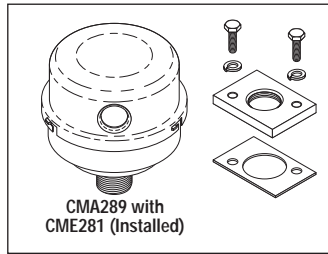

RPI Part #CMK280
OEM Part #'s - See Chart Above

AIR INTAKE UPGRADE KIT

- **Important!** See *Notes* below
- Includes: Air Filter Assembly (RPI Part #CMA289), Air Intake Filter Element (RPI Part #CME281), PM Sticker, mounting bracket, gasket, and mounting hardware

Fits: Compressor Head

Note: This Kit replaces the old "rectangular" style filter.

RPI Part #CMA289
OEM Part #'s - See Chart Above

AIR FILTER ASSEMBLY

- **Important!** See *Notes* below
- Port: 3/4" MPT
- 2 Microns
- Includes: Air Intake Filter Element (RPI Part #CME281) and PM Sticker
- Included in: Air Intake Upgrade Kit (RPI Part #CMK280)

Fits: Air Intake Manifold

NEW PART
Fits Scroll Style Compressors

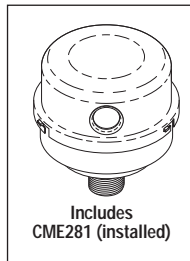

RPI Part #CME281
OEM Part #'s - See Chart Above

AIR INTAKE FILTER ELEMENT

- **Important!** See *Notes* below
- Size: 4.12" OD x 4.50" lg.
- 2 Microns
- Included in: Air Filter Assembly (RPI Part #CMA289), Air Intake Upgrade Kit (RPI Part #CMK280), Compressor PM Kit (RPI Part #CMK274), and Compressor PM & Tip Seal Kit (RPI Part #CMK286)

Fits: Upgraded Air Intake Filter Assembly

NEW PART
Fits Scroll Style Compressors



Notes: This Air Filter Assembly and Air Filter Element is only a replacement for the newer round-shaped style Air Intake Filter Assembly.

This Filter and Assembly is not to be used with the older discontinued rectangular-style Air Intake Filter Assembly. To convert from the older style assembly to the newer round-shaped style assembly, see RPI's Air Intake Upgrade Kit (RPI Part #CMK280).

NEW PART



CME288

RPI Part #CMF282
OEM Part #'s - See Chart Above

AIR INTAKE FILTER

- **Important!** See *Notes* below
- Size: 2" dia. x 3.4" lg. x 1/4" MPT
- 50 Microns
- Includes: Air Filter Element (RPI Part #CME288)

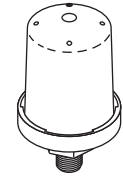

NEW PART

RPI Part #CME288
OEM Part #'s - See Chart Above

AIR FILTER ELEMENT

- **Important!** See *Notes* below
- Size: 1.30" OD x .62" ID x 1.00" lg.
- 50 Microns

Fits: Air Intake Filter Housing



Notes: Apollo/Midmark: This Air Intake Filter only fits the air filter housing with a single threaded port on the older style AOCRS11 and AOCRS12 models.

This is not to be used on the newer style AOCRS11 and AOCRS12 models where the housing has two ports, one at each end of the housing.

RPI Part #PCS624
OEM Part #'s - See Chart Above

FILTER SCREEN

- 3 per package
- Copper 20 mesh

Fits: Motor Housing

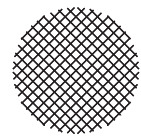

RPI Part #PCF625
OEM Part #'s - See Chart Above

FILTER (FELT)

- 12 per package

Fits: Air Inlet

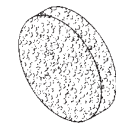

RPI Part #PCC626
OEM Part #'s - See Chart Above

FILTER CAP (AIR INLET)

- Aluminum

Fits: Head Assembly

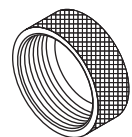

FILTERS - COALESCING AND PARTICULATE FILTER ELEMENTS

RPI PART #	DESCRIPTION	APOLLO/ MIDMARK®	DENTALEZ®/ CUSTOM AIR/RAMVAC	JUN-AIR	MATRIX/ MIDMARK®	MIDMARK®	TECH WEST
CMK005	COALESCING FILTER ELEMENT (WILKERSON® Part #MSP-95-988) • Type B, 0.5 micron	ACA86050 Type B, Wilkerson Filter only	648-00209 Type B, Wilkerson Filter only	648-00209 Type B, Wilkerson Filter only	77005005 Type B, Wilkerson Filter only	77005009 Type B, Wilkerson Filter only	
CMK006	COALESCING FILTER ELEMENT (WILKERSON® Part #MSP-95-989) • Type B, 0.5 micron	ACA86055 Type B, Wilkerson Filter only	645-45010 Type B, Wilkerson Filter only	JA4081500 Type B, Wilkerson Filter only		77005002	CFE-375 Type B, Wilkerson Filter only
CMK024	COALESCING FILTER ELEMENT (WILKERSON® Part #MTP-95-548) • Type C, 0.01 micron	ACA86050 Type C, Wilkerson Filter only	648-00209 Type C, Wilkerson Filter only	648-00209 Type C, Wilkerson Filter only	77005005 Type C, Wilkerson Filter only	77005009 Type C, Wilkerson® Filter only	
CMK025	COALESCING FILTER ELEMENT (WILKERSON® Part #MTP-95-549) • Type C, 0.01 micron	ACA86055 Type C, Wilkerson Filter only	645-45010 Type C, Wilkerson Filter only	JA4081500 Type C, Wilkerson Filter only			CFE-375 Type C, Wilkerson Filter only
CMK026	COALESCING FILTER ELEMENT (GENERIC BRAND) • Type C, 0.01 micron	ACA86050 Type C, Generic Filter only	648-00209 Type C, Generic Filter only	648-00209 Type C, Generic Filter only	77005005 Type C, Generic Filter only	77005009 Type C, Generic Filter only	
CMK027	COALESCING FILTER ELEMENT (GENERIC BRAND) • Type C, 0.01 micron	ACA86055 Type C, Generic Filter only	645-45010 Type C, Generic Filter only	JA4081500 Type C, Generic Filter only			CFE-375 Type C, Generic Filter only



RPI Part #CMK005
OEM Part #'s - See Chart Above

COALESCING FILTER ELEMENT

- Wilkerson® (MSP-95-988)
- Size: 1.59" OD x 2.05" lg.
- **Type B**; 0.5 micron
- Includes all parts as shown and PM sticker
- Fits:** Wilkerson® brand M16 (5 oz.) Series Coalescing Filter Assembly

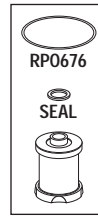

RPI Part #CMK024
OEM Part #'s - See Chart Above

COALESCING FILTER ELEMENT

- Wilkerson® (MTP-95-548)
- Size: 1.59" OD x 2.05" lg.
- **Type C**; 0.01 micron
- Includes all parts as shown and PM sticker
- Fits:** Wilkerson® brand M16 (5 oz.) Series Coalescing Filter Assembly



RPI Part #CMK026
OEM Part #'s - See Chart Above

COALESCING FILTER ELEMENT

- Generic brand
- Size: 1.75" OD x 2.03" lg.
- **Type C**; 0.01 micron
- Includes all parts as shown and PM sticker
- Fits:** Wilkerson® brand M16 (5 oz.) Series Coalescing Filter Assembly



RPI Part #CMK006
OEM Part #'s - See Chart Above

COALESCING FILTER ELEMENT

- Wilkerson® (MSP-95-989)
- Size: 1.89" OD x 2.82" lg.
- **Type B**; 0.5 micron
- Includes: Filter Element, Seal, Bowl O-ring (RPI Part #RPO677), PM sticker, and (1) additional Bowl O-ring (RPI Part #RPO675)
- Fits:** Wilkerson® brand M26 (10 oz.) Series Coalescing Filter Assembly

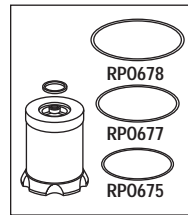

RPI Part #CMK025
OEM Part #'s - See Chart Above

COALESCING FILTER ELEMENT

- Wilkerson® (MTP-95-549)
- Size: 1.89" OD x 2.80" lg.
- **Type C**; 0.01 micron
- Includes all parts as shown and PM sticker
- Fits:** Wilkerson® brand M26 (10 oz.) Series Coalescing Filter Assembly

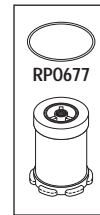

RPI Part #CMK027
OEM Part #'s - See Chart above

COALESCING FILTER ELEMENT

- Generic brand
- Size: 1.75" OD x 2.75" lg.
- **Type C**; 0.01 micron
- Includes all parts as shown and PM sticker
- Fits:** Wilkerson® brand M26 (10 oz.) Series Coalescing Filter Assembly

Air Techniques, Apollo/Midmark®, MDT McKesson, DentalEZ®/Custom Air/RamVac, Jun-Air, MatrX/Midmark®, Midmark®, Pelton & Crane, and Tech West/Turbine Ind.

FILTERS - COALESCING AND PARTICULATE FILTER ELEMENTS *(continued)*

RPI PART #	DESCRIPTION	AIR TECHNIQUES	DENTALEZ®/ CUSTOM AIR/RAMVAC	JUN-AIR	TECH WEST
CME043	COALESCING FILTER ELEMENT (Wilkerson® Brand)		004005		
CME044	COALESCING FILTER ELEMENT (Wilkerson® Brand)		003846		
CME083	PARTICLE FILTER ELEMENT (Norgren® Brand)	85602			
CME085	PARTICLE FILTER ELEMENT (Wilkerson® Brand)	86193			
CME102	CARBON FILTER ELEMENT	87367			
CME103	FILTER ELEMENT	87366			
CME104	CARBON FILTER ELEMENT		JA4080500	64800-213	
CME105	COALESCING FILTER ELEMENT		JA4081600	64800-214	
CME107	FILTER ELEMENT		JA4081602	4081602	
CME110	COALESCING FILTER ELEMENT				CFEO-375
CME227	COALESCING FILTER ELEMENT		005150		
CME228	PARTICULATE FILTER ELEMENT		005151		

RPI Part #CME043

OEM Part #'s - See Chart Above

COALESCING FILTER ELEMENT

- Wilkerson® brand
- Size: 1.38" OD x 2.20" lg.
- Type B: .5 micron
- Includes all parts as shown and PM Sticker

Fits: Coalescing Filter Assembly



RP0685

RPI Part #CME102

OEM Part #'s - See Chart Above

FILTER ELEMENT

- Size: 1.53" OD x 2.70" lg.
- 35 micron filter
- Includes all parts as shown and PM Sticker

Fits: Bottom of the Membrane Dryer Assembly (Air Techniques Part #87175)

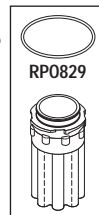

RP0829

RPI Part #CME107

OEM Part #'s - See Chart Above

FILTER ELEMENT

- Size: 1.42" OD x 2.75" lg.
- 0.01 micron
- Includes all parts as shown and PM Sticker

Fits: "D" Series Absorption Dryers

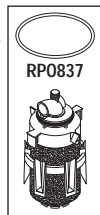

RP0837

RPI Part #CME044

OEM Part #'s - See Chart Above

COALESCING FILTER ELEMENT

- Wilkerson® brand
- Size: 1.38" OD x 2.20" lg.
- Type C: 0.01 micron
- Includes all parts as shown and PM Sticker

Fits: Coalescing Filter Assembly



RP0685

RPI Part #CME103

OEM Part #'s - See Chart Above

FILTER ELEMENT

- Size: 1.12" OD x 2.74" lg.
- 2 micron paper filter
- Includes all parts as shown and PM Sticker

Fits: Top of the Membrane Dryer Assembly (Air Techniques Part #87175)

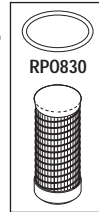

RP0830

RPI Part #CME110

OEM Part #'s - See Chart Above

COALESCING FILTER ELEMENT

- Size: 1.39" OD x 2.50" lg.
- 0.01 micron filter material
- Includes all parts as shown and PM Sticker

Fits: Coalescing Filter Assembly (Tech West Part #CFAO-375 & Parker/Balston Part #2003N-1B1-BX) only

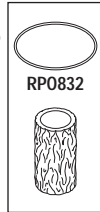

RP0832

RPI Part #CME083

OEM Part #'s - See Chart Above

PARTICLE FILTER ELEMENT

- Norgren® brand
- Size: .93" OD x 1.44" lg.
- 5 micron filter element
- Includes all parts as shown and PM Sticker
- Also available: Particle Filter Assembly (RPI Part #CMA082)

Fits: Norgren® brand F73 Series Particle Filter Assembly



RP0718

RPI Part #CME104

OEM Part #'s - See Chart Above

CARBON FILTER ELEMENT

- Size: 1.55" O.D. x 2.63" lg.
- Type "D" 0.003 PPM activated carbon
- Includes all parts as shown and PM Sticker

Fits: Coalescing Combination Filter Assembly



RP0831

O-RING

RPI Part #CME227

OEM Part #'s - See Chart above

COALESCING FILTER ELEMENT

- 0.30 Micron filter material
- Includes all parts as shown and PM Sticker

Fits: Coalescing Filter Assembly

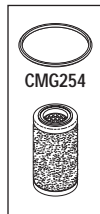

CMG254

RPI Part #CME085

OEM Part #'s - See Chart Above

PARTICLE FILTER ELEMENT

- Wilkerson® brand
- Size: 1.30" OD x 1.62" lg.
- 5 micron filter element
- Includes all parts as shown and PM Sticker
- Also available: Particle Filter Assembly (RPI Part #CMA084)

Fits: Wilkerson® brand B18, F18 & M18 Series Particle Filter Assembly



RP0685

RPI Part #CME105

OEM Part #'s - See Chart Above

COALESCING FILTER ELEMENT

- Size: 1.38" OD x 2.62" lg.
- 0.01 micron filter element
- Includes all parts as shown and PM Sticker

Fits: Coalescing Combination Filter Assembly

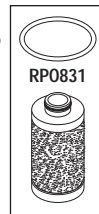

RP0831

RPI Part #CME228

OEM Part #'s - See Chart Above

PARTICULATE FILTER ELEMENT

- 0.01 Micron filter material
- Includes all parts as shown and PM Sticker

Fits: Particulate Filter Assembly

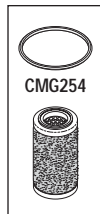

CMG254

FILTERS - FOAM INSERTS/PURGE FILTERS/PURGE MUFFLERS

RPI PART #	DESCRIPTION	AIR TECHNIQUES	APOLLO/MIDMARK®	DENTAL EZ®/CUSTOM AIR/RAMVAC	MATRIX/MIDMARK®	MIDMARK®	TECH WEST
CMF012	FOAM INSERT/PURGE FILTER						FA-100
CMM017	PURGE MUFFLER	80330					AS-250
CMM023	PURGE MUFFLER						PM-500
CMM237	PURGE MUFFLER			004088			
CMM238	PURGE MUFFLER			005082			
CMM261	PURGE MUFFLER			004856			
CMS128	PURGE MUFFLER		62983300		62983300	62983300	
RPF834	FILTER/MUFFLER		No OEM Part # Available		No OEM Part # Available	No OEM Part # Available	No OEM Part # Available

RPI Part #CMF012
OEM Part #'s - See Chart Above

FOAM INSERT/PURGE FILTER

- Size: 5.00" OD x 5.50" lg.
- Material: Reticulated foam
- Includes PM Sticker

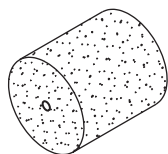

It's the RPI Advantage! Also includes a PM Sticker that can be attached to the filter housing for recording the date that the filter was replaced.

RPI Part #CMM017
OEM Part #'s - See Chart Above

PURGE MUFFLER

- Size: 1-1/4" lg.; 1/4" MPT with 9/16" hex
- Material: Sintered bronze

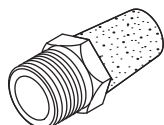

RPI Part #CMM023
OEM Part #'s - See Chart Above

PURGE MUFFLER

- Size: 2-3/4" lg.; 1/2" MPT with 7/8" hex
- Material: Zinc plated steel body

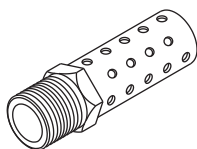

RPI Part #CMM237
OEM Part #'s - See Chart Above

PURGE MUFFLER

- Port Size: 1/4" MPT
 - Size: 13/16" OD x 2-7/16" lg. with 11/16" hex
 - Material: Polyvinyl foam
- Fits:** Dryer Assembly

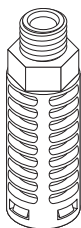

RPI Part #CMM238
OEM Part #'s - See Chart Above

PURGE MUFFLER

- Port Size: 3/8" MPT
 - Size: 1" OD x 2 5/8" lg. with 1" hex
 - Material: Polyvinyl foam
- Fits:** Dryer Assembly

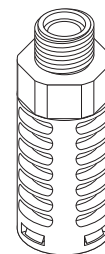

RPI Part #CMM261
OEM Part #'s - See Chart Above

PURGE MUFFLER

- Port Size: 1/8" MPT
 - Size: .51" OD x 1.50" lg. with 1" hex
 - Material: Sintered copper alloy
- Fits:** Dryer Assembly

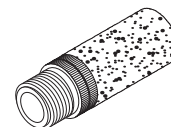

RPI Part #RPF834
OEM Part #'s - See Chart Above

FILTER/MUFFLER

- Size: 1" OD X 2-3/4" O/A lg.; 3/8" MPT
 - Material: Plastic threads with Hope element
 - Included in: Collection Container Kit (RPI Part #CMK180)
- Fits:** Collection Container Kit (RPI Part #CMK180)



RPI Part #CMS128
OEM Part #'s - See Chart Above

EXHAUST SILENCER

- Port Size: 1/2" FPT
 - 1/4" (6mm) drain tubing connector
 - Silences exhaust and eliminates mist
 - Service Tip: It is recommended to replace twice a year
 - Also available: Adaptor (1/4" MPT x 1/4" MPT) (RPI Part #RPF833), Adaptor (1/4" FPT x 1/2" MPT) (RPI Part #RPF818), Drain Tubing (RPI Part #RPT604), Collection Container Kit (RPI Part #CMK181), and PM Sticker
- Fits:** Purge Solenoid Valve

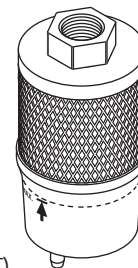

It's the RPI Advantage! Also includes a PM Sticker that can be attached to the exhaust silencer for recording the date that the exhaust silencer was replaced.

FITTINGS



RPI Part #RPF651
OEM Part # (No OEM Part # Available)

ADAPTOR FITTING (3/8" TUBE x 1/8" MPT)

- Material: Acetal
 - Included in: Auto Float Drain (RPI Part #CMF016), Coalescing Filter Assembly - 5 oz. (RPI Part #CMA021), and Coalescing Filter Assembly - 10 oz. (RPI Part #CMA022)
- Fits:** 3/8" tube to 1/8" MPT

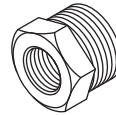

RPI Part #RPF818
OEM Part #62903606

ADAPTOR (1/4" FPT x 1/2" MPT)

- 2 per package
 - Material: Brass
 - Also available: Exhaust Silencer (RPI Part #CMS128)
- Fits:** Connects Exhaust Silencer to Solenoid Valve

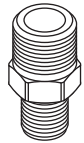

RPI Part #RPF828
OEM Part # (No OEM Part # Available)

ADAPTOR (1/4" MPT x 3/8" MPT)

- 2 per package
 - Material: Brass
 - Included in: Unloader Valve (RPI Part #CMV121)
- Fits:** Unloader Valve

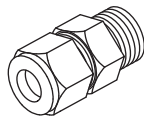

RPI Part #RPF662
OEM Part # (No OEM Part # Available)

MALE CONNECTOR (3/8" TUBE x 1/4" MPT)

- Material: Brass
 - Includes: Compression Nut (RPI Part #RPF222) and Compression Sleeve (RPI Part #RPF218)
 - Included in: Collection Container Kit (RPI Part #CMK180) and Unloader Valve (RPI Part #CMV123)
- Fits:** Collection Container Kit and Unloader Valve

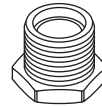

RPI Part #RPF826
OEM Part # (No OEM Part # Available)

ADAPTOR (3/8" FPT x 1/2" MPT)

- 2 per package
 - Material: Brass
 - Included in: Unloader Valve (RPI Part #CMV121)
- Fits:** Unloader Valve

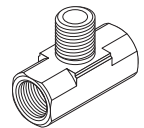

RPI Part #RPF860
OEM Part # (No OEM Part # Available)

MALE BRANCH TEE (1/4" FPT x 1/4" MPT)

- Material: Brass
 - Included in: Check Valve Upgrade Kit (RPI Part #CMK249)
- Fits:** 1/4" FPT and MPT Ports

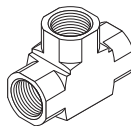

RPI Part #RPF690
OEM Part # (No OEM Part # Available)

TEE FITTING (1/4" FPT)

- Material: Brass
 - Included in: Check Valve Upgrade Kit (RPI Part #'s CMK247 & CMK248)
- Fits:** 1/4" FPT ports

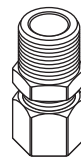

RPI Part #RPF827
OEM Part # (No OEM Part # Available)

MALE CONNECTOR (3/8" TUBE x 3/8" MPT)

- 2 per package
 - Material: Brass
 - Included in: Unloader Valve (RPI Part #CMV121)
- Fits:** Unloader Valve



RPI Part #RPF833
OEM Part #77002055

ADAPTOR (1/4" MPT x 1/4" MPT)

- 2 per package
 - Material: Brass
 - Included in: Fresh Air Intake Filter Kit (RPI Part #CMK003)
 - Also available: Exhaust Silencer (RPI Part #CMS128)
- Fits:** Connects Exhaust Silencer to Solenoid Valve

FITTINGS (continued)

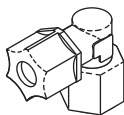

RPI Part #RPF835
OEM Part # (No OEM Part # Available)

ELBOW FITTING (3/8" TUBE x 3/8" FPT)

- Material: Durable Nylon®
- Included in: Collection Container Kit (RPI Part #CMK180)

Fits: Collection Container Kit (RPI Part #CMK180)



RPI Part #RPF857
OEM Part # (No OEM Part # Available)

ADAPTOR (1/4" FPT x 3/8" MPT)

- 2 per package
- Material: Brass
- Included in: Collection Container Kit (RPI Part #CMK180)

Fits: Collection Container Kit (RPI Part #CMK180)

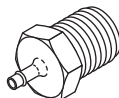

RPI Part #RPF914
OEM Part # (No OEM Part # Available)

ADAPTOR (1/16" BARB x 1/8" MPT)

- 5 per package
- Material: Brass
- Included in: Solenoid Valve (Regeneration System) (RPI Part #'s CMV250 & CMV251)

Fits: 1/16" ID Tubing x 1/8" FPT Ports

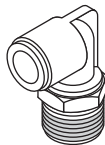

RPI Part #RXF024
OEM Part #003863SP; 56133

ELBOW (3/8" PUSH-IN x 3/8" MPT)

- 5 per package
- Material: Brass swivel fitting with plastic push-in chuck
- Included in: Check Valve Upgrade Kit (RPI Part #'s CMK247, CMK248 & CMK249)

Fits: 3/8" FPT Port and 3/8" OD Tubing

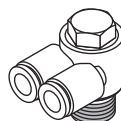

RPI Part #RXF025
OEM Part #56192

BRANCH ELBOW (DUAL 1/4" PUSH-IN x 1/4" MPT)

- Material: Brass fitting with dual plastic push-in elbow
- Included in: Check Valve Upgrade Kit (RPI Part #'s CMK247, CMK248 & CMK249)
- Also available: Tubing (.170" ID x 1/4" OD Natural) (RPI Part #RPT380)

Fits: 1/4" OD Tubing x 1/4" FPT Port

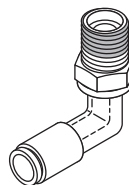

RPI Part #RXF029
OEM Part # (No OEM Part # Available)

ELBOW FITTING (1/4" PUSH-IN x 1/4" MPT)

- 2 per package
- Material: Brass swivel elbow with plastic push-in chuck
- Included in: Check Valve Upgrade Kit (RPI Part #'s CMK247, CMK248 & CMK249)
- Also available: Tubing (.170" ID x 1/4" OD Natural) (RPI Part #RPT380)

Fits: 1/4" FPT Port and 1/4" OD Tubing

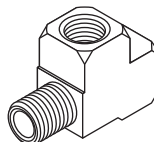

RPI Part #RXF030
OEM Part # (No OEM Part # Available)

STREET TEE (1/4" NPT)

- Material: Brass
- Included in: Check Valve Upgrade Kit (RPI Part #'s CMK247, CMK248 & CMK249)

Fits: 1/4" FPT and MPT Ports



RPI Part #RXF031
OEM Part # (No OEM Part # Available)

MALE CONNECTOR (1/4" PUSH-IN x 1/4" MPT)

- 2 per package
- Material: Brass with plastic push-in chuck
- Included in: Check Valve Upgrade Kit (RPI Part #CMK248)

Fits: 1/4" FPT Port and 1/4" OD Tubing

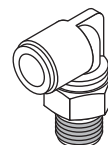

RPI Part #RXF033
OEM Part #56119

ELBOW FITTING (3/8" PUSH-IN x 1/4" MPT)

- 2 per package
- Material: Brass swivel fitting with plastic push-in chuck
- Included in: Check Valve Upgrade Kit (RPI Part #'s CMK247, CMK248 & CMK249)

Fits: 3/8" OD Tubing x 1/4" FPT Port

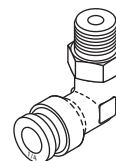

RPI Part #RXF037
OEM Part #56113

SWIVEL ELBOW (1/4" PUSH-IN x 1/8" MPT)

- 2 per package
- Material: Nickel plated brass swivel fitting with plastic push-in chuck
- Included in: Solenoid Valve (Regeneration System) (RPI Part #'s CMV250 & CMV251)

Fits: Regeneration Assembly

Air Techniques, Apollo/Midmark®, MDT McKesson, DentalEZ®/Custom Air/RamVac, Jun-Air, MatrX/Midmark®, Midmark®, Pelton & Crane, and Tech West/Turbine Ind.

OIL, COLLECTION CONTAINERS & MORE

RPI PART #	DESCRIPTION	AIR TECHNIQUES	APOLLO/MIDMARK®	DENTALEZ®/CUSTOM AIR/RAMVAC	JUN-AIR	MATR/MIDMARK®	MDT MCKESSON	MIDMARK®	PELTON & CRANE	TECH WEST
CMK180	COLLECTION CONTAINER KIT Use with Pressurized Purge Systems		AKCSL100D	SPA95400		AMD-100 CL-10		CL21 P21		ACL2S1
CMK181	COLLECTION CONTAINER KIT Use with Gravity Drain Systems		AKCSL100D AOCOS11D	SPA95400		AMD-100 CL-10		CL21 P21		ACL2S1
CML001	COMPRESSOR OIL - (1) 16 oz. bottle	60051 (1) 16 oz. bottle	ACA85921 (1) 16 oz. bottle	64651001 (1) 16 oz. bottle		77000220 (1) 16 oz. bottle	3-08-0084-30 (1) 16 oz. bottle	No OEM Part # Available	No OEM Part # Available	CO-100 (1) 16 oz. bottle
CML045	COMPRESSOR OIL (CASE) - (12) 16 oz. bottles	60051 (1) 16 oz. bottle	ACA85921 (1) 16 oz. bottle	64651001 (1) 16 oz. bottle		77000220 (1) 16 oz. bottle	3-08-0084-30 (1) 16 oz. bottle	No OEM Part # Available	No OEM Part # Available	CO-100 (1) 16 oz. bottle
CML119	SYNTHETIC COMPRESSOR OIL - (1) 16 oz. bottle			JA64651-004 (1) 16 oz. bottle	64651-004 (1) 16 oz. bottle					
CML120	SYNTHETIC COMPRESSOR OIL (CASE) (12) 16 oz. bottles			JA64651-004 (1) 16 oz. bottle	64651-004 (1) 16 oz. bottle					
RPB838	DISPOSAL BAG	No OEM Part # Available	No OEM Part # Available	No OEM Part # Available	No OEM Part # Available	No OEM Part # Available	No OEM Part # Available	No OEM Part # Available	No OEM Part # Available	No OEM Part # Available
RPB939	BOTTLE (1 Liter / 32 fl. oz.)	No OEM Part # Available	No OEM Part # Available	No OEM Part # Available	No OEM Part # Available	No OEM Part # Available	No OEM Part # Available	No OEM Part # Available	No OEM Part # Available	No OEM Part # Available
RPP958	ABSORBENT PAD - 3/PKG	No OEM Part # Available	No OEM Part # Available	No OEM Part # Available	No OEM Part # Available	No OEM Part # Available	No OEM Part # Available	No OEM Part # Available	No OEM Part # Available	No OEM Part # Available
RPT842	SYRINGE PUMP/EXTRACTOR	No OEM Part # Available	No OEM Part # Available	No OEM Part # Available	No OEM Part # Available	No OEM Part # Available	No OEM Part # Available	No OEM Part # Available	No OEM Part # Available	No OEM Part # Available
RPV841	DRAIN VALVE		PVV50525 (Plug)			No OEM Part # Available	No OEM Part # Available			No OEM Part # Available

RPI Part #CML001
OEM Part #'s - See Chart Above

COMPRESSOR OIL

- 16 oz. (0.75L) bottle; ISO100
- Includes: Extended Yorker Spout
- For use with most Copeland® head compressors
- Included in: Compressor PM Kits (see pages 400-402)



RPI Part #CML119
OEM Part #'s - See Chart Above

SYNTHETIC COMPRESSOR OIL

- 16 oz. (0.75L) bottle; ISO Grade 46; Equivalent to SJ-27F
- Includes: Extended Yorker Spout
- Included in: Compressor PM Kits (see page 400)



Also available by the Case - (12) 16 oz. Bottles!
COMPRESSOR OIL (CASE)
RPI Part #CML045

Also available by the Case - (12) 16 oz. Bottles!
SYNTHETIC COMPRESSOR OIL (CASE)
RPI Part #CML120

Great for compressor waste water and oil collection and disposal!

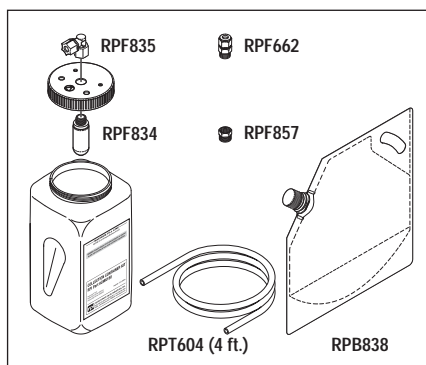

RPI Part #CMK180
OEM Part #'s - See Chart Above

COLLECTION CONTAINER KIT

- For use with Pressurized Purge Systems
- Tubing can be cut to desired length depending on proximity of compressor to collection container
- **It's the RPI Advantage!** This one-of-kind collection bottle can replace the purge drain lines and be directly connected with tubing to the compressor so that the purge waste water and oil can be collected and disposed of properly according to local, state and federal regulations.

Fits: Purge Assembly

Models: All Lubricated Compressors with Pressurized Purge Systems

Great for compressor waste water and oil collection and disposal!

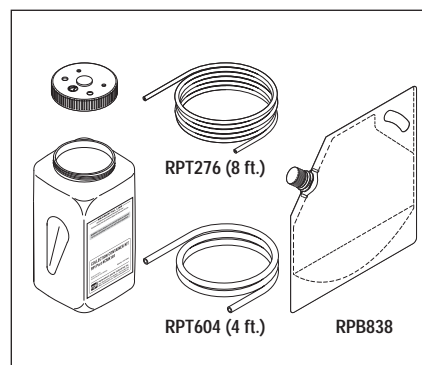

RPI Part #CMK181
OEM Part #'s - See Chart Above

COLLECTION CONTAINER KIT

- For use with Gravity Drain Systems
- Tubing can be cut to desired length depending on proximity of compressor to collection container
- Accommodates up to 2 ea. 1/4" dia. tubing and 1 ea. 3/8" dia. tubing
- **It's the RPI Advantage!** This one-of-kind collection bottle can replace the purge drain lines and be directly connected with tubing to the compressor so that the purge waste water and oil can be collected and disposed of properly according to local, state and federal regulations.

Fits: Purge Assembly

Models: All Lubricated Compressors with Gravity Drain systems

OIL, COLLECTION CONTAINERS & MORE (continued)

5 ESSENTIAL TOOLS FOR AN EASIER OIL CHANGE!

1 **SYRINGE PUMP/EXTRACTOR (RPI Part #RPT842)**

This one-of-a-kind tool allows complete removal of oil from a compressor without needing to tilt or disassemble the unit!

2 **DRAIN VALVE (RPI Part # RPV841)**

Upgrade to RPI's one-of-a-kind Drain Valve which has a special Tee-handle that allows you to easily open and close the valve to control the flow of oil as it is draining into the Disposal Bag!

3 **DISPOSAL BAG (RPI Part #RPB838) OR BOTTLE (RPI Part #RPB939)**

Either the Disposable Bag with expandable base and built in handle (1 gallon), or the Bottle (1 liter) is the perfect solution for carrying, storing and disposing of used oil. Both the bag and bottle are constructed of durable clear plastic, and include a tight sealing cap.

4 **COLLECTION CONTAINER KITS (RPI Part #'s CMK180 & CMK181) - shown on page 429**

These one-of-kind collection bottles can replace the purge drain lines and be directly connected with tubing to the compressor so that the purge waste water and oil can be collected and disposed of properly according to local, state and federal regulations.

5 **ABSORBENT PAD (RPI Part #RPP958)**

This 9-1/4" x 14-1/2" pad is perfect for oil drip collection and spills and is sold in a package of 3!

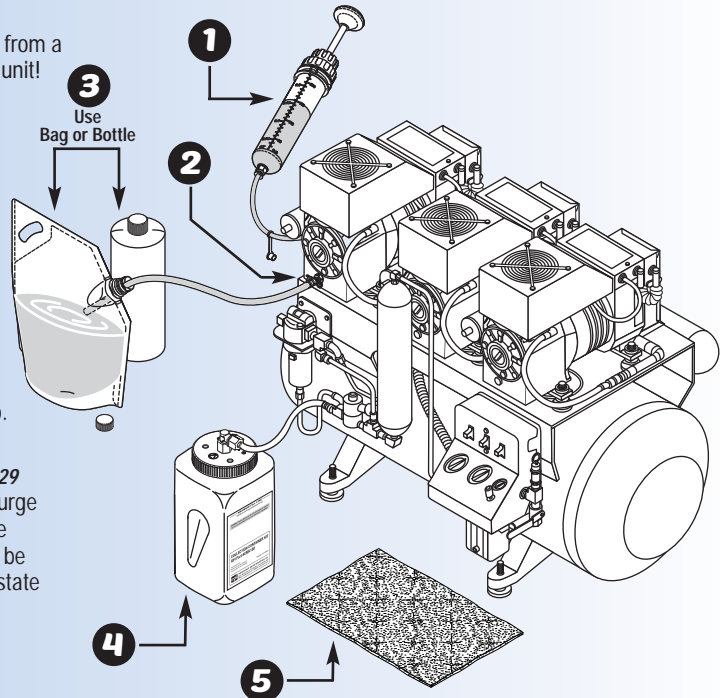

1 *It's the RPI Advantage! This one-of-a-kind tool allows complete removal of oil from a compressor without needing to tilt or disassemble the unit.*

RPI Part #RPT842
OEM Part # (No OEM Part # Available)

SYRINGE PUMP/EXTRACTOR

- 200 CC capacity, clear body
- Includes all parts as shown
- Also available: Cap (RPI Part #RPC847), and Seal Kit (RPI Part #RPK846)

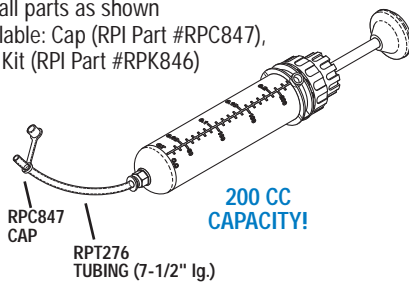

2 *It's the RPI Advantage! Replace the existing drain plug with RPI's new, one-of-a-kind Drain Valve to make your next oil change a breeze. RPI's Drain Valve has a special Tee-handle that allows you to easily open and close the valve to control the flow of oil as it is draining into the disposal bag (RPI Part #RPB838) or Bottle (RPI Part #RPB939).*

RPI Part #RPV841
OEM Part #PVV50525

DRAIN VALVE

- Tee handle: Material: Brass body/Steel handle • Size: 1/8" MPT • Includes all parts as shown • Also available: 1/4" Teflon Thread Sealing Tape (RPI Part #RPT579) and Tubing (5/16" ID x 7/16" OD Clear) (RPI Part #RPT849) - sold by the foot

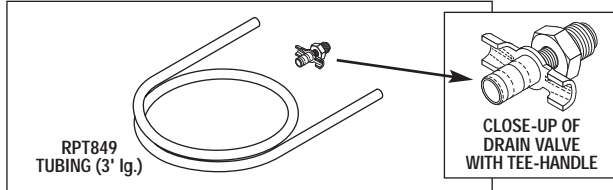

USE THE BOTTLE OR BAG FOR COLLECTION & DISPOSAL!

RPI Part #RPB939
OEM Part # (No OEM Part # Available)

BOTTLE

- (1 Liter / 32 fl. oz.)
- Can be used for used oil collection
- 3-3/4" OD x 8.00" tall
- Material: HDPE plastic
- Clear durable plastic bottle with tight sealing cap



3 RPI Part #RPB838
OEM Part # (No OEM Part # Available)

DISPOSAL BAG (1 Gallon)

- Can be used for used oil collection
- 3 per package
- Clear durable plastic bag with tight sealing cap, built in handle and expandable base

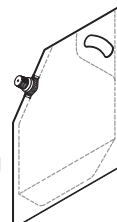

RPI Part #CMK180 & RPI Part #CMK181
OEM Part #SPA95400

COLLECTION CONTAINER KITS

- See page 429 for a complete description of these RPI Kits

RPI Part #RPP958
OEM Part # (No OEM Part # Available)

ABSORBENT PAD

- Can be used for oil drip collection and spills
- 3 per package

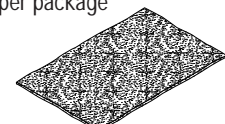

Size: 9-1/4" x 14-1/2"

Call Us Toll-Free Monday-Friday, 8:00 AM-4:30 PM (Pacific Time), (800) 221-9723

Air Techniques, Apollo/Midmark®, MDT McKesson, DentalEZ®/Custom Air/RamVac, Jun-Air, Matrix/Midmark®, Midmark®, Pelton & Crane, and Tech West/Turbine Ind.

POWER SWITCHES & CIRCUIT BREAKERS

RPI Part #PCS643
OEM Part #011290

POWER SWITCH ASSEMBLY

- 20A @ 250VAC
- (On/Off) toggle switch; SPDT
- Fits 1/2" dia. mounting hole
- Includes mounting hardware

Fits: Electrical Box

Models: 420-C (Serial #22302 and above)
& 840-C (Serial #4530 and above)

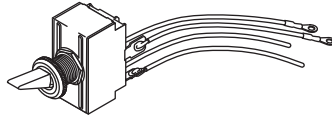

RPI Part #VPS177
OEM Part #85838

POWER SWITCH

- Toggle switch (On/Off)
- 20A @ 120/277VAC, SPDT
- Screw terminals
- See **Note** below for quantity required for each model

Fits: Electrical Control Box

Models: AirStar 10, AirStar 100M, AirStar 10D, AirStar 21, AirStar 21D, AirStar 22, AirStar 22D, AirStar 30, AirStar 30D, AirStar 30M, AirStar 40, AirStar 40M, AirStar 50, AirStar 50D, AirStar 50M, AirStar 70, AirStar 70D, AirStar 70M, VacStar 50, VacStar 50H, VacStar 80 & VacStar 80H

Note: Air Techniques: AirStar 10D, AirStar 21D and AirStar 22D requires (1) power switch. AirStar 30D, AirStar 30M, AirStar 40M, AirStar 50D, AirStar 50M and AirStar 100M requires (2) power switches. AirStar 70D and AirStar 70M requires (3) power switches.

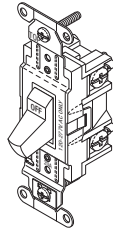

RPI Part #CMS209
OEM Part #86065 & 86063

POWER SWITCH/ CIRCUIT BREAKER (10A)

- On/Off power switch
- 10A @ 250VAC
- #10-32 screw terminals

Fits: Electrical Control Box

Models: AirStar 10M, AirStar 10D (May 2006 to Current), AirStar 30M (May 2006 to Current) & AirStar 30D (May 2004 to Current)

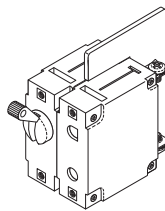

RPI Part #CMS210
OEM Part #56148

POWER SWITCH/ CIRCUIT BREAKER (8A)

- On/Off power switch
- 8A @ 250VAC
- #10-32 screw terminals

Fits: Electrical Control Box

Models: AirStar 12M, AirStar 22M, AirStar 22D, VacStar 50 & VacStar 50H

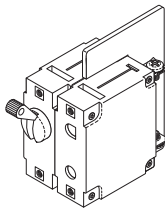

RPI Part #CMS212
OEM Part #86064

POWER SWITCH/ CIRCUIT BREAKER (15A)

- On/Off power switch
- 15A @ 250VAC
- #10-32 screw terminals

Fits: Electrical Control Box

Models: AirStar 40M, AirStar 50M & AirStar 50D (May 2006 to Current)

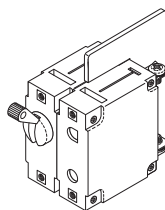

RPI Part #CMS213
OEM Part #86066

POWER SWITCH/ CIRCUIT BREAKER (22A)

- On/Off power switch
- 22A @ 250VAC
- #10-32 screw terminals

Fits: Electrical Control Box

Models: AirStar 70M (May 2006 to Current) & AirStar 70D (May 2006 to Current)

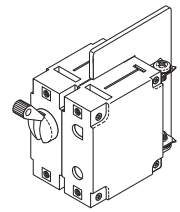

RPI Part #CMS214
OEM Part #85367

POWER SWITCH/ CIRCUIT BREAKER (8A)

- On/Off power switch
- 8A @ 250VAC
- #8-32 screw terminals

Fits: Electrical Control Box

Models: AirStar 70M (1996 to April 2006) & AirStar 70D (1996 to April 2006)

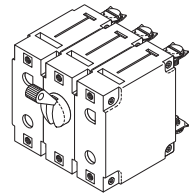

RPI Part #CMS215
OEM Part #85363

POWER SWITCH/ CIRCUIT BREAKER (5A)

- On/Off power switch
- 5A @ 250VAC
- #8-32 screw terminals

Fits: Electrical Control Box

Models: AirStar 30D (1996 to April 2004)

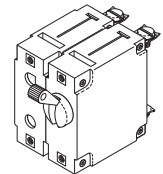

RPI Part #VPB164
OEM Part #117690

CIRCUIT BREAKER (1/4A)

- 1/4A @ 250VAC
- 1/4" tabs
- Panel Cutout: 5/8" dia.
- Push to reset

Fits: Electrical Control Box

Models: AirStar 10D, AirStar 12M, AirStar 21D, AirStar 21M, AirStar 22D, AirStar 22M, AirStar 30D, AirStar 30M, AirStar 40M, AirStar 50D, AirStar 50M, AirStar 70D, AirStar 70M & AirStar 100M

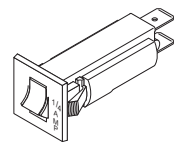

RPI Part #VPB182
OEM Part #117061

CIRCUIT BREAKER (1/2A)

- 1/2A @ 250VAC
- 1/4" tabs
- Panel Cutout: 5/8" dia.
- Push to reset

Fits: Electrical Control Box

Models: AirStar 10D, AirStar 10M, AirStar 21D, AirStar 22D, AirStar 30D, AirStar 50D & AirStar 70D

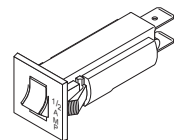

RELAYS

RPI PART #	DESCRIPTION	AIR TECHNIQUES	APOLLO/MIDMARK®	DENTALEZ®/CUSTOM AIR/RAMVAC	MATRX/MIDMARK®	MIDMARK®	PELTON & CRANE	TECH WEST
CMR032	RELAY (UNIVERSAL)	60501 62501 64501 66501	HCA30652 HCA30653 HCA30654 HCA30655	Included in 645011010 & 645011011	Included in 77001344 77001345 & 77001346	Included in 77001345 & 77001346		PR-115 PR-208
CMR200	RELAY (ELECTRICAL CONTACTOR)	89345 & 85773						
PCR635	RELAY						005172 & 004843	
VPR151	RELAY (ELECTRICAL CONTACTOR)	54498						

RPI Part #CMR032
OEM Part #'s - See Chart Above

RELAY (UNIVERSAL)

- Size: 2.00" L x 1.84" W x 1.30" H
- Universal mounting configuration
- 110-270VAC single phase
- Max voltage contact rating: 502VAC
- Motor power rating: up to 10HP
- Includes: .25" quick connect tabs, and (6x) tab to screw adaptors

Fits: Start Box

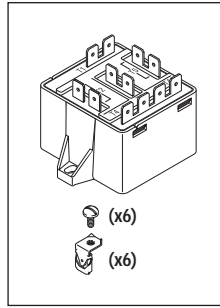

RPI Part #VPR151
OEM Part #'s - See Chart Above

RELAY (ELECTRICAL CONTACTOR)

- Size: 2-1/2" L x 2-3/8" W x 2.91" H
- Coil: 24VAC, 7 ohms
- 3 pole; Contacts rated at 40A
- 1/4" Tabs

Fits: Electrical Control Box

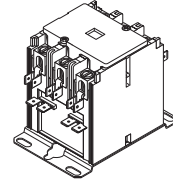

RPI Part #CMR200
OEM Part #'s - See Chart Above

RELAY (ELECTRICAL CONTACTOR)

- Size: 2-3/8" L x 2-1/2" W x 2.91" H
- Coil: 24VAC, 7 ohms
- 2 pole, contacts rated at 40A
- 1/4" Tabs

Fits: Electrical Control Box

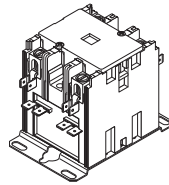

RPI Part #PCR635
OEM Part #'s - See Chart Above

RELAY

- Size: 2.00" L x 1-3/4" W x 1-9/16" H
- 115VAC/220VAC (3ARR3-63)
- #8-32 screw terminals (1/4" tabs)

Fits: Electrical Control Box

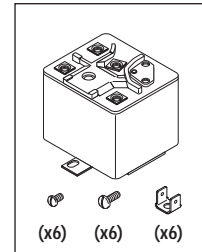

TRANSFORMERS



RPI Part #VPT142
OEM Part #85934, 86637, 85275 & 85362

TRANSFORMER

- Size: 2-5/8" L x 2-3/16" W x 2-3/16" H
- Primary: 120/208/240VAC; 50/60Hz.
- Secondary: 24VAC @ 40A
- Includes all parts as shown
- 1/4" Tabs

Fits: Electrical Control Box

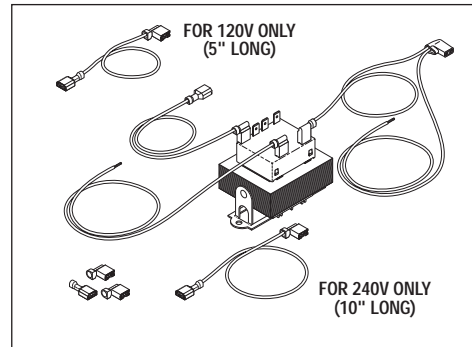

NOTES: _____

Air Techniques, Apollo/Midmark®, MDT McKesson, DentalEZ®/Custom Air/RamVac, Jun-Air, MatrX/Midmark®, Midmark®, Pelton & Crane, and Tech West/Turbine Ind.

PRESSURE SWITCHES & VALVES

RPI PART #	DESCRIPTION	AIR TECHNIQUES	APOLLO/MIDMARK®	DENTAL EZ®/CUSTOM AIR/RAMVAC	JUN-AIR	TECH WEST
CMS051	PRESSURE SWITCH		ECS10445			
CMS052	PRESSURE SWITCH		ECS10455			
CMS053	PRESSURE SWITCH					PCS-3
CMS054	PRESSURE SWITCH			JA5074800		
CMS055	PRESSURE SWITCH				JA5075200	
CMV058	UNLOADER VALVE				No OEM Part # Available	
CMV059	PRESSURE RELIEF VALVE	No OEM Part # Available	PW05526			
CMV060	PRESSURE RELIEF VALVE		No OEM Part # Available			
RPO303	O-RING				No OEM Part # Available	
RPT670	TUBING (4 mm ID x 6 mm OD Black)				No OEM Part # Available	

RPI Part #CMS051
OEM Part # - See Chart Above

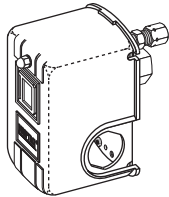

PRESSURE SWITCH

- 115/230VAC
- Contacts: N.C. SPDT
- Factory set to: Off @ 100 PSI
- 3/8" FPT Input port
- Includes: 2-way Pressure Relief Valve (RPI Part #CMV060)

RPI Part #CMV060
OEM Part # - See Chart Above

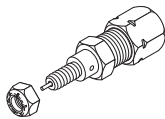

PRESSURE RELIEF VALVE

- Brass
- Fits 1/4" dia. mounting hole
- Includes: 1/4" Tubing Compression Nut, Ferrule and mounting hardware

RPI Part #CMS052
OEM Part # - See Chart Above

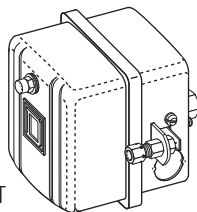

PRESSURE SWITCH

- 115/230VAC
- Contacts: N.C. SPDT
- Factory set to: On @ 75 PSI - Off @ 100 PSI
- 1/4" FPT Input port
- Includes: 2-way Pressure Relief Valve (RPI Part #CMV059)

RPI Part #CMV059
OEM Part # - See Chart Above

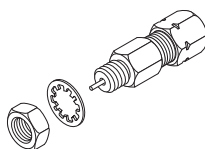

PRESSURE RELIEF VALVE

- Brass
- Fits 5/16" dia. mounting hole
- Includes: 1/4" Tubing Compression Nut, Ferrule and mounting hardware

RPI Part #CMS053
OEM Part # - See Chart Above

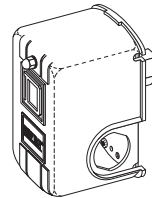

PRESSURE SWITCH

- 115/230VAC
- Contacts: N.C. SPDT
- Factory set to: On @ 80 PSI - Off @ 100 PSI
- 1/4" FPT Input port

RPI Part #CMS054
OEM Part # - See Chart Above

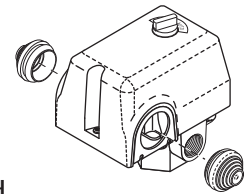

PRESSURE SWITCH

- 115/230VAC
- Contacts: N.C. SPDT
- Factory set to: On @ 90 PSI (6.2 Bar) - Off @ 116 PSI (8.0 Bar)
- 4-port 1/4" BSP manifold
- Auto/Off control
- Includes (2) Cable Grommets

RPI Part #CMS055
OEM Part #'s - See Chart Above

PRESSURE SWITCH

- 115/230VAC
- Contacts: N.C. SPDT
- Factory set to: On @ 90 PSI (6.2 Bar) - Off @ 116 PSI (8.0 Bar)
- 1/4" BSPP manifold port
- Auto/Off control
- Includes: Unloader Valve (RPI Part #CMV058), 40" Tubing (RPI Part #RPT670), Tube Adaptor Fitting, Elbow Fitting, Conduit Connectors and Quick Connect Fitting with O-ring (RPI Part #RPO303)

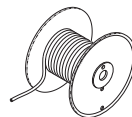
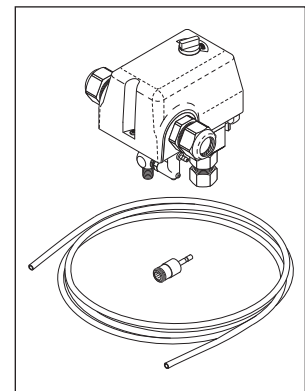

RPI Part #RPT670
OEM Part #'s - See Chart Above

TUBING (4 mm ID x 6 mm OD Black)

- Sold by the foot (reel not included)
- Polyurethane tubing
- Fits: 4mm Barbs or 6mm Push-In Fittings



ACTUAL SIZE

RPI Part #RPO303
OEM Part #'s - See Chart Above

O-RING

- 12 per package
- Size: .364" ID x .504" OD x .070" C/S
- Material: Nitrile (Buna N); Duro: 70
- Fits: Pressure Switch Quick Connect Fitting

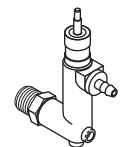

RPI Part #CMV058
OEM Part #'s - See Chart Above

UNLOADER VALVE

- Plastic body; 1/8" BSP
- 4mm barb fitting

PRESSURE SWITCHES & VALVES *(continued)*

RPI PART #	DESCRIPTION	AIR TECHNIQUES	APOLLO/MIDMARK®	MATRX/MIDMARK®	MIDMARK®
CMS056	PRESSURE SWITCH	85465			
CMS057	PRESSURE SWITCH	60016			
CMS131	PRESSURE SWITCH			77005143	77005143
CMS208	PRESSURE SWITCH	85979, 87176 & 86436		77005143	77005143
CMV059	PRESSURE RELIEF VALVE	No OEM Part # Available	PV05526		

RPI Part #CMS057
OEM Part # -
See Chart Above

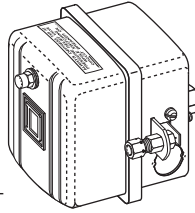

PRESSURE SWITCH

- 115/230VAC
- Contacts: N.C. SPDT
- Factory set to:
On @ 80 PSI - Off @ 100 PSI
- 1/4" FPT Input port w/orifice
- Includes: 2-way Pressure Relief Valve (RPI Part #CMV059)

RPI Part #CMS056
OEM Part # - See
Chart Above

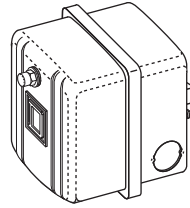

PRESSURE SWITCH

- 115/230VAC
- Contacts: N.C. SPDT
- Factory set to:
On @ 80 PSI - Off @ 100 PSI
- 1/4" FPT Input port

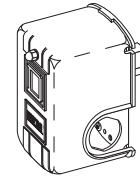

RXT017
(11" lg.)

RPI Part #CMS208
OEM Part # - See Chart Above

PRESSURE SWITCH

- 115/230VAC
- Contacts: N.C. DPST
- Factory set to:
On @ 85 PSI - Off @ 115 PSI
- 1/4" NPSF input port
- Includes: 11" Tubing (6.5mm ID x 10mm OD Black) (RPI Part #RXT017)

RPI Part #CMV059
OEM Part # -
See Chart Above

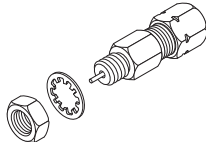

PRESSURE RELIEF VALVE

- Brass
- Fits 5/16" dia. mounting hole
- Includes: 1/4" Tubing Compression Nut, Ferrule and mounting hardware

RPI Part #CMS131
OEM Part # - See
Chart Above

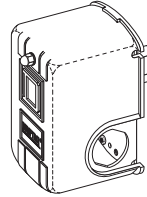

PRESSURE SWITCH

- 115/230VAC
- Contacts: N.C. DPST
- Factory set to: On @ 80 PSI - Off @ 100 PSI
- 1/4" FPT input port

PRESSURE GAUGES

RPI PART #	DESCRIPTION	AIR TECHNIQUES	APOLLO/MIDMARK®	DENTALEZ®/CUSTOM AIR/RAMVAC	JUN-AIR	MATRX/MIDMARK®	MDT McKESSON	MIDMARK®	TECH WEST
CMG048	PRESSURE GAUGE (160 PSI)	60011	PCA70400			77005012		20150201	CPG-250
CMG049	PRESSURE GAUGE (300 PSI)	No OEM Part # Available	No OEM Part # Available	No OEM Part # Available	No OEM Part # Available	No OEM Part # Available	No OEM Part # Available	No OEM Part # Available	No OEM Part # Available
CMG050	PRESSURE GAUGE (230 PSI)				JA5130000				
RPT579	1/4" TEFLON THREAD SEALING TAPE	No OEM Part # Available	No OEM Part # Available	No OEM Part # Available	No OEM Part # Available	No OEM Part # Available	No OEM Part # Available	No OEM Part # Available	No OEM Part # Available

RPI Part #CMG048
OEM Part #'s - See Chart Above

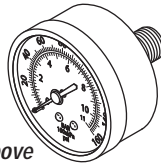

PRESSURE GAUGE (160 PSI)

- 2" dial; Polycarbonate lens
- Dual scale: 0-160 PSI & 0-11 Bar
- 1/4" MPT center back mount

RPI Part #CMG050
OEM Part #'s - See Chart Above

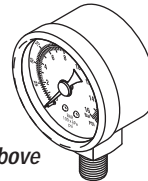

PRESSURE GAUGE (230 PSI)

- 1.5" dial; Polycarbonate lens
- Dual scale: 0-230 PSI & 0-16 Bar
- 1/8" BSPP bottom mount

RPI Part #CMG049
OEM Part #'s - See Chart Above

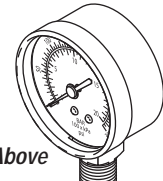

PRESSURE GAUGE (300 PSI)

- 2" dial; Polycarbonate lens
- Dual scale: 0-300 PSI & 0-20.6 Bar
- 1/4" MPT bottom mount

Don't forget the Teflon® Tape for use with the pressure gauges!

RPI Part #RPT579
OEM Part #'s - See Chart Above
1/4" TEFLON THREAD SEALING TAPE

- 5 per package
- 1/4" x 260" per unit



Air Techniques, Apollo/Midmark®, MDT McKesson, DentalEZ®/Custom Air/RamVac, Jun-Air, MatrX/Midmark®, Midmark®, Pelton & Crane, and Tech West/Turbine Ind.

SAFETY VALVES

RPI PART #	DESCRIPTION	AIR TECHNIQUES	APOLLO/MIDMARK®	JUN-AIR	MATR/MIDMARK®	MDT McKESSON	MIDMARK®	TECH WEST
CMV046	SAFETY VALVE (125 PSI)	60017	PVV50560		77005020	3-08-0813-00	77005020	POVA-100
CMV047	SAFETY VALVE (135 PSI)			JA5417000				

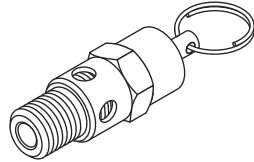

RPI Part #CMV046
OEM Part # - See Chart Above

SAFETY VALVE (125 PSI)
 • Brass; 1/4" MPT
 • Cracking pressure: 125 PSI

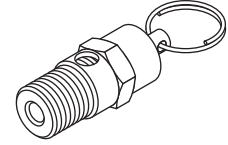

RPI Part #CMV047
OEM Part # - See Chart Above

SAFETY VALVE (135 PSI)
 • Brass; 1/4" BSPP
 • Cracking pressure: 135 PSI

SIGHT GLASSES & SIGHT GLASS TOOL

RPI PART #	DESCRIPTION	AIR TECHNIQUES	APOLLO/MIDMARK®	MATR/MIDMARK®	MDT McKESSON	MIDMARK®	PELTON & CRANE	TECH WEST
CMK097	SIGHT GLASS KIT	60100	ACA85322 & ASA85322	77000812	3-08-0012-10			OSG-100
CMK098	SIGHT GLASS KIT	60100	ACA85322	77000812	3-08-0012-10 Sight Glass Only			OSG-100
PCG634	SIGHT GLASS (OIL)						60100	
RPT705	SIGHT GLASS TOOL	No OEM Part # Available	ACA00050	No OEM Part # Available	301789	No OEM Part # Available		No OEM Part # Available

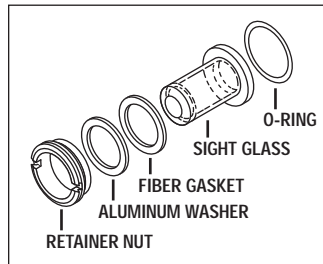

RPI Part #CMK097
OEM Part #'s - See Chart Above

SIGHT GLASS KIT
 • Includes all parts as shown
 • Also available: Sight Glass Tool (RPI Part #RPT705)
Fits: Copeland head lubricated compressors

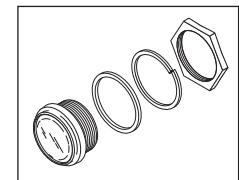

RPI Part #PCG634
OEM Part # - See Chart Above

SIGHT GLASS (OIL)
 • Glass lens
 • Includes seal and mounting hardware
 • No Sight Glass Tool required
Fits: Motor Housing

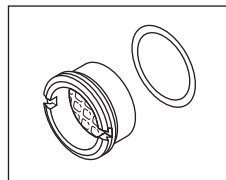

RPI Part #CMK098
OEM Part #'s - See Chart Above

SIGHT GLASS KIT
 • Steel retainer body with built in sight glass
 • Includes all parts as shown
 • Also available: Sight Glass Tool (RPI Part #RPT705)
Fits: Copeland head lubricated compressors

DON'T FORGET THE SIGHT GLASS TOOL!

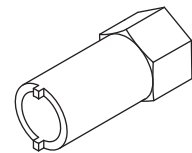

RPI Part #RPT705
OEM Part #'s - See Chart Above

SIGHT GLASS TOOL
 • For easy removal and installation of sight glasses
Fits: Copeland head lubricated compressors

SOLENOID VALVES & REPAIR KITS

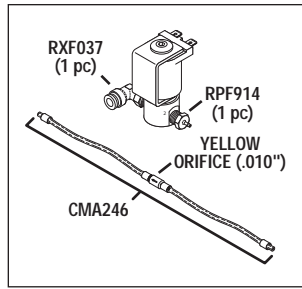

RPI Part #CMV250
OEM Part #85839

**SOLENOID VALVE
(REGENERATION SYSTEM)**

- 24/60VAC, 50Hz., 8.5W; 1/4" tabs, (8.6 Ohms)
- Ports: 1/8" FPT; 2-way; N.C.
- Includes: Orifice Assembly (.010") (RPI Part #CMA246), Swivel Elbow (1/4" Push-In x 1/8" MPT) (RPI Part #RXF037), and Adaptor (1/16" Barb x 1/8" MPT) (RPI Part #RPF914)
- Also available: Solenoid Valve Repair Kit, (RPI Part #VPK006), 1/8" Sleeve Tool (RPI Part #RPT294), and Universal Sleeve Tool (RPI Part #RPT296)

Fits: Regeneration System

Models: AirStar 50D and AirStar 70D

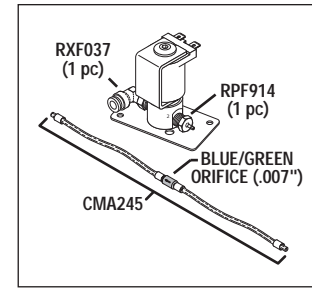

RPI Part #CMV251
OEM Part #85834

**SOLENOID VALVE
(REGENERATION SYSTEM)**

- 24/60VAC, 50Hz., 8.5W; 1/4" tabs, (8.6 Ohms)
- Ports: 1/8" FPT; 2-way; N.C.
- Includes: Orifice Assembly (.007") (RPI Part #CMA245), Swivel Elbow (1/4" Push-In x 1/8" MPT) (RPI Part #RXF037), Adaptor (1/16" Barb x 1/8" MPT) (RPI Part #RPF914), and mounting bracket
- Also available: Solenoid Valve Repair Kit, (RPI Part #VPK006), 1/8" Sleeve Tool (RPI Part #RPT294), and Universal Sleeve Tool (RPI Part #RPT296)

Fits: Regeneration System

Models: AirStar 10D, AirStar 21D, AirStar 22D & AirStar 30D

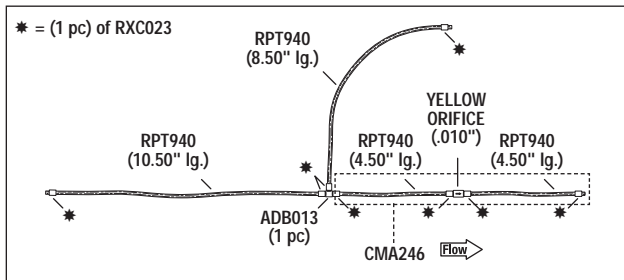

RPI Part #CMA252
OEM Part #89185



**REGENERATION
ORIFICE ASSEMBLY**

- Includes: Orifice Assembly (.010") (RPI Part #CMA246), 28" Tubing (1/16" ID x 1/8" OD Clear) (RPI Part #RPT940), (8 pc) Sleeve Clamp (1/8") (RPI Part #RXC023), and (1 pc) Barb Tee (RPI Part #ADB013)
- Also available: 1/8" Sleeve tool (RPI Part #RPT294) and Universal Sleeve Tool (RPI Part #RPT296)

Fits: Purge System

Models: AirStar 50D & AirStar 70D

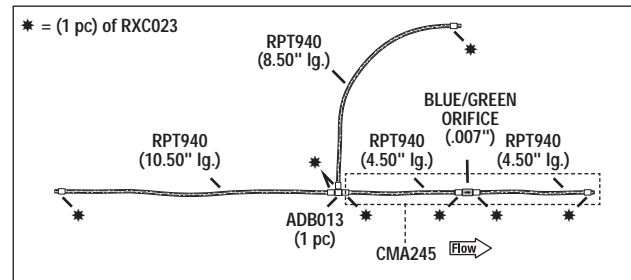

RPI Part #CMA253
OEM Part #89183



**REGENERATION
ORIFICE ASSEMBLY**

- Includes: Orifice Assembly (.007") (RPI Part #CMA245), 28" Tubing (1/16" ID x 1/8" OD Clear) (RPI Part #RPT940), (8 pc) Sleeve Clamp (1/8") (RPI Part #RXC023) and (1pc) Barb Tee (RPI Part #ADB013)
- Also available: 1/8" Sleeve tool (RPI Part #RPT294) and Universal Sleeve Tool (RPI Part #RPT296)

Fits: Purge system

Models: AirStar 10D, AirStar 21D, AirStar 22D & AirStar 30D

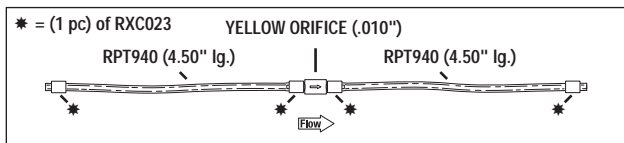

RPI Part #CMA246
OEM Part #85412



ORIFICE ASSEMBLY (.010")

- Orifice .010"
- Includes: Orifice, Tubing (1/16" ID x 1/8" OD Clear) (RPI Part #RPT940), and (4 pc) Sleeve Clamp (1/8") (RPI Part #RXC023)
- Also available: 1/8" Sleeve tool (RPI Part #RPT294) and Universal Sleeve Tool (RPI Part #RPT296)

Fits: Purge System

Models: AirStar 50D & AirStar 70D

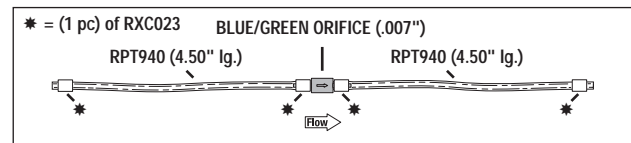

RPI Part #CMA245
OEM Part #85411



ORIFICE ASSEMBLY (.007")

- Orifice .007"
- Includes: Orifice, Tubing (1/16" ID x 1/8" OD Clear) (RPI Part #RPT940), and (4 pc) Sleeve Clamp (1/8") (RPI Part #RXC023)
- Also available: 1/8" Sleeve tool (RPI Part #RPT294) and Universal Sleeve Tool (RPI Part #RPT296)

Fits: Purge System

Models: AirStar 10D, AirStar 21D, AirStar 22D & AirStar 30D

Air Techniques, Apollo/Midmark®, MDT McKesson, DentalEZ®/Custom Air/RamVac, Jun-Air, MatrX/Midmark®, Midmark®, Pelton & Crane, and Tech West/Turbine Ind.

SOLENOID VALVES & REPAIR KITS (continued)

RPI PART #	DESCRIPTION	AIR TECHNIQUES	DENTALEZ®/ CUSTOM AIR/RAMVAC
CMK258	SOLENOID VALVE REPAIR KIT		No OEM Part # Available
CMK260	SOLENOID VALVE REPAIR KIT		No OEM Part # Available
CMM237	PURGE MUFFLER		004088
CMM238	PURGE MUFFLER		005082
CMM261	PURGE MUFFLER		004856
CMV255	SOLENOID VALVE		004980
CMV257	SOLENOID VALVE		8801-024
CMV259	SOLENOID VALVE		8801-025
VPK006	SOLENOID VALVE REPAIR KIT	No OEM Part # Available	
TUC084	WIRE CONNECTOR WITH GASKET <i>Available but not shown on this page</i>		No OEM Part # Available

RPI Part #CMV255
OEM Part #'s - See
Chart Above

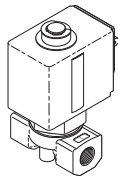

SOLENOID VALVE

- 24VDC; 4 1/2 W; (128 Ohms)
- Ports: 1/8" FPT; 2-Way; N.O.
- Also available: Purge Muffler (RPI Part #CMM261), and Wire Connector with Gasket (RPI Part #TUC084)

Fits: Dryer Assembly

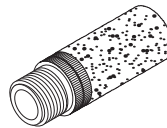

RPI Part #CMM261
OEM Part #'s - See
Chart Above

PURGE MUFFLER

- Size: .51" OD x 1.50" lg.
- Port Size: 1/8" NPT
- Material: Sintered copper alloy

Fits: Dryer Assembly

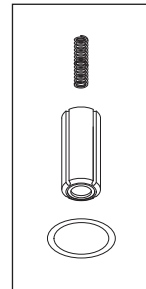

RPI Part #VPK006
OEM Part #'s - See
Chart Above

SOLENOID VALVE REPAIR KIT

- Includes all parts as shown
- Also available: Solenoid Valve (Regeneration System) (RPI Part #'s CMV250 & CMV251) see page 436

Fits: Solenoid Valve (Regeneration System)

RPI Part #CMV257
OEM Part #'s - See
Chart Above

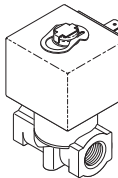

SOLENOID VALVE

- 24VAC 50/60 Hz., 8W (10 Ohms)
- Ports: 1/4" FPT; 2-Way; N.C.
- **Note:** There are 2 solenoid valves per unit
- Also available: Solenoid Valve Repair Kit (RPI Part #CMK258), Purge Muffler (RPI Part #CMM237), and Wire Connector with Gasket (RPI Part #TUC084)

Fits: Dryer Assembly

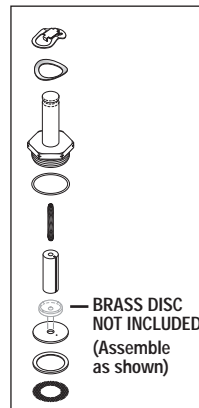

RPI Part #CMK258
OEM Part #'s - See
Chart Above

SOLENOID VALVE REPAIR KIT

- Buna-N Seal
- Includes all parts as shown
- **Note:** There are 2 solenoid valves per unit
- Also available: Solenoid Valve (RPI Part #CMV257)

Fits: Dryer Assembly

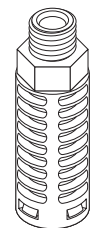

RPI Part #CMM237
OEM Part #'s - See
Chart Above

PURGE MUFFLER

- Size: 13/16" OD x 2-7/16" lg with 11/16" hex
- Port Size: 1/4" MPT
- Material: Polyvinyl foam

Fits: Dryer Assembly

RPI Part #CMV259
OEM Part #'s - See
Chart Above

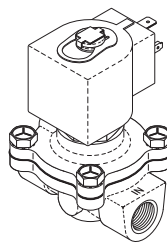

SOLENOID VALVE

- 24VDC 50/60 Hz., 11.5W (50 Ohms)
- Ports: 3/8" FPT; 2-Way; N.C.
- **Note:** There are 2 solenoid valves per unit
- Also available: Solenoid Valve Repair Kit (RPI Part #CMK260), Purge Muffler (RPI Part #CMM238); and Wire Connector (RPI Part #TUC084)

Fits: Dryer Assembly

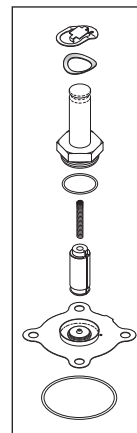

RPI Part #CMK260
OEM Part #'s - See
Chart Above

SOLENOID VALVE REPAIR KIT

- Includes all parts as shown
- **Note:** There are 2 solenoid valves per unit
- Also available: Solenoid Valve (RPI Part #CMV259)

Fits: Dryer Assembly

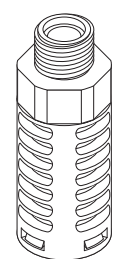

RPI Part #CMM238
OEM Part #'s - See
Chart Above

PURGE MUFFLER

- Size: 1" OD x 2 5/8" lg with 1" hex
- Port Size: 3/8" NPT
- Material: Polyvinyl foam

Fits: Dryer Assembly

SOLENOID VALVES & REPAIR KITS (continued)

RPI PART #	DESCRIPTION	AIR TECHNIQUES	APOLLO/MIDMARK®	DENTAL EZ®/CUSTOM AIR/RAMVAC	MATRIX/MIDMARK®	MIDMARK®	TECH WEST
CMK133	SOLENOID VALVE REPAIR KIT	85423					
CMK136	SOLENOID VALVE REPAIR KIT		No OEM Part # Available		No OEM Part # Available	No OEM Part # Available	
CMK139	SOLENOID VALVE REPAIR KIT						No OEM Part # Available
CMV132	SOLENOID VALVE (PURGE)	85179, 85377-1, 85423 & 85946					
CMV134	SOLENOID VALVE (PURGE)	85377-2, 85378, 85379 & 85424					
CMV135	SOLENOID VALVE (PURGE)		PVV70501 & ACA85332		77001324 & 77001571	002-1390-00 & 002-1391-00	
CMV137	SOLENOID VALVE (PURGE)		PVV70502 & ACA85332		77001325, 77001570 & 77001572	002-1383-00, 002-1384-00, 002-1385-00, 002-1386-00, 002-1387-00, 002-1388-00 & 002-1389-00	
CMV138	SOLENOID VALVE (PURGE)						DSV-115
CMV140	SOLENOID VALVE (PURGE)						DSV-230

RPI Part #CMV132
OEM Part #'s - See Chart Above

SOLENOID VALVE (PURGE)

- 120VAC, 60 Hz., 9.5 W, FWR
- Ports: 1/4" FPT; 2-way; N.O.
- Includes: Solenoid valve, 2 ft. flex conduit with fittings, and 48" wires with terminals
- Also available: Solenoid Valve Repair Kit (RPI Part #CMK133) and Adaptor (RPI Part #RPF833)

Fits: Purge Assembly

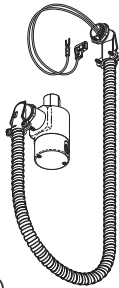

RPI Part #CMV134
OEM Part #'s - See Chart Above

SOLENOID VALVE (PURGE)

- 230VAC, 60 Hz., 9.5 W, FWR
- Ports: 1/4" FPT; 2-way; N.O.
- Includes: Solenoid valve, 2 ft. flex conduit with fittings, and 48" wires with terminals
- Also available: Solenoid Valve Repair Kit (RPI Part #CMK133) and Adaptor (RPI Part #RPF833)

Fits: Purge Assembly

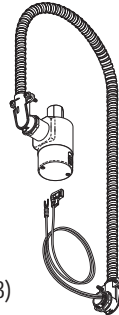

RPI Part #CMK133
OEM Part #'s - See Chart Above

SOLENOID VALVE REPAIR KIT

- Piston style repair kit
- Includes all parts as shown
- Also available: Solenoid Valve (Purge) (RPI Part #'s CMV132 & CMV134), Double Ended Spanner Wrench (RPI Part # RPT501), Spanner Nut (RPI Part # ILS014), and High Temp Lubricant (RPI Part #RPL090)

Fits: Solenoid Valve (Purge)

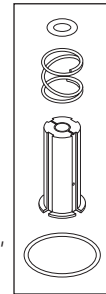

RPI Part #CMV135
OEM Part #'s - See Chart Above

SOLENOID VALVE (PURGE)

- 120VAC, 50/60 Hz., 8W (156 Ohms)
- Ports: 1/4" FPT; N.O.
- Includes: Solenoid valve, 24" wires and (3) #10 ring terminal
- Also available: Solenoid Valve Repair Kit (RPI Part #CMK136), Exhaust Silencer (RPI Part #CMS128), and Adaptor (RPI Part #RPF833)

Fits: Purge Assembly

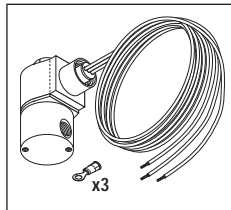

RPI Part #CMV137
OEM Part #'s - See Chart Above

SOLENOID VALVE (PURGE)

- 208VAC, 60 Hz., 8W (503 Ohms)
- Ports: 1/4" FPT; N.O.
- Includes: Solenoid valve, 24" wires and (3) #10 ring terminal
- Also available: Solenoid Valve Repair Kit (RPI Part #CMK136), Exhaust Silencer (RPI Part #CMS128), and Adaptor (RPI Part #RPF833)

Fits: Purge Assembly

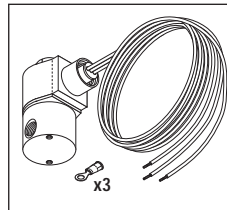

RPI Part #CMK136
OEM Part #'s - See Chart Above

SOLENOID VALVE REPAIR KIT

- Piston style repair kit
- Includes all parts as shown
- Also available: Solenoid Valve (Purge) (RPI Part #'s CMV135 & CMV137)

Fits: Purge Solenoid Valve

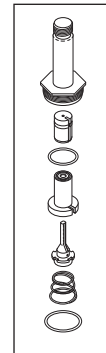

RPI Part #CMV138
OEM Part #'s - See Chart Above

SOLENOID VALVE (PURGE)

- 120VAC, 50/60 Hz., 8W (115 Ohms)
- Ports: 1/4" FPT; N.O.
- Includes: Solenoid valve, 24" wires and (3) #10 ring terminal
- Also available: Solenoid Valve Repair Kit (RPI Part #CMK136), Exhaust Silencer (RPI Part #CMS128), and Adaptor (RPI Part #RPF833)

Fits: Purge Assembly

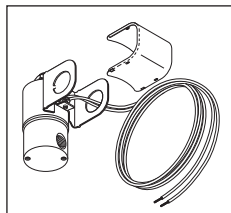

RPI Part #CMV140
OEM Part #'s - See Chart Above

SOLENOID VALVE (PURGE)

- 120VAC, 50/60 Hz., 11W (467 Ohms)
- Ports: 1/4" FPT; N.O.
- Includes: Solenoid valve and 24" wires with conduit knock out for left or right wire exit
- Also available: Solenoid Valve Repair Kit (RPI Part #CMK139) and Adaptor (RPI Part #RPF833)

Fits: Purge Assembly

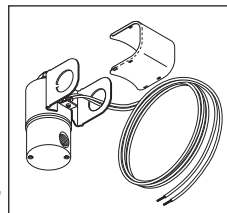

RPI Part #CMK139
OEM Part #'s - See Chart Above

SOLENOID VALVE REPAIR KIT

- Includes all parts as shown
- Also available: Solenoid Valve (Purge) (RPI Part #'s CMV138 & CMV140)

Fits: Purge Solenoid Valve

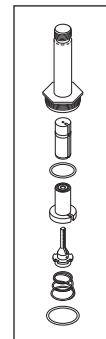

Air Techniques, Apollo/Midmark®, MDT McKesson, DentalEZ®/Custom Air/RamVac, Jun-Air, Matrix/Midmark®, Midmark®, Pelton & Crane, and Tech West/Turbine Ind.

START BOXES

RPI PART #	DESCRIPTION	AIR TECHNIQUES	APOLLO/MIDMARK®	DENTALEZ®/CUSTOM AIR/RAMVAC	MATRIX/MIDMARK®	MIDMARK®	TECH WEST
CMA029	START BOX (1HP, 208/230V)	66515	SPD95291		77001346	77001346	CRA-208
CMA033	START BOX (1HP, 230V)	66500	SPD95290	645011011	77001344		CRA-230
CMA035	START BOX (1HP, 115V)	62500	SPD95280	645011010	77001345		CRA-115
CMA039	START BOX (3/4HP, 208/230V)	64515	SPD95285 SPD95286				
CMA041	START BOX (3/4HP, 115V)	60500	SPD95275				

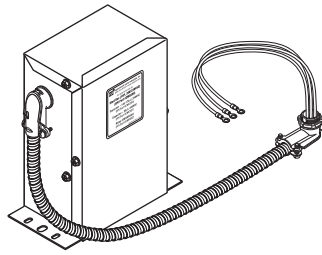

RPI Part #CMA029
OEM Part #'s - See Chart Above

START BOX (1HP, 208/230V)

- Size: 7.38" L x 4.71" W x 3.21" D
- Material: 20 ga. Galvanized Steel
- Start Box for 1HP 208/230VAC Compressor Heads
- Includes: Start Capacitor (RPI Part #CMC030), Run Capacitor (RPI Part #CMC031) and Relay (RPI Part #CMR032)

Fits: Compressor

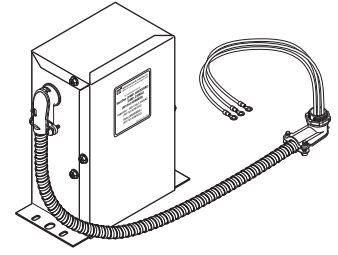

RPI Part #CMA039
OEM Part #'s - See Chart Above

START BOX (3/4HP, 208/230V)

- Size: 7.38" L x 4.71" W x 3.21" D
- Material: 20 ga. Galvanized Steel
- Start Box for 3/4HP 208/230VAC or 3/4HP 230VAC Compressor Heads
- Includes: Start Capacitor (RPI Part #CMC030) and Relay (RPI Part #CMR032)

Fits: Compressor

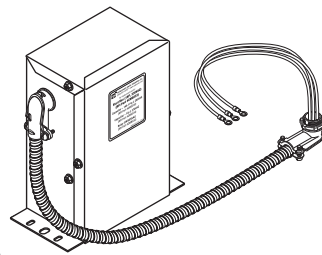

RPI Part #CMA033
OEM Part #'s - See Chart Above

START BOX (1HP, 230V)

- Size: 7.38" L x 4.71" W x 3.21" D
- Material: 20 ga. Galvanized Steel
- Start Box for 1HP 230VAC Compressor Heads
- Includes: Start Capacitor (RPI Part #CMC030), Run Capacitor (RPI Part #CMC031) and Relay (RPI Part #CMR032)

Fits: Compressor

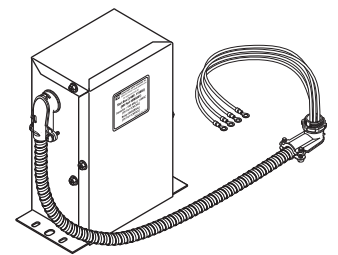

RPI Part #CMA041
OEM Part #'s - See Chart Above

START BOX (3/4HP, 115V)

- Size: 7.38" L x 4.71" W x 3.21" D
- Material: 20 ga. Galvanized Steel
- Start Box for 3/4HP 115VAC Compressor Heads
- Includes: Start Capacitor (RPI Part #CMC042) and Relay (RPI Part #CMR032)

Fits: Compressor

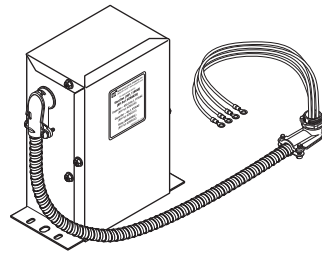

RPI Part #CMA035
OEM Part #'s - See Chart Above

START BOX (1HP, 115V)

- Size: 7.38" L x 4.71" W x 3.21" D
- Material: 20 ga. Galvanized Steel
- Start Box for 1HP 115VAC Compressor Heads
- Includes: Start Capacitor (RPI Part #CMC036), Run Capacitor (RPI Part #CMC037) and Relay (RPI Part #CMR032)

Fits: Compressor

SPECIFICATIONS

For Capacitors, see page 414
For Relays, see page 432

THERMAL PROTECTOR ASSEMBLIES

RPI PART #	DESCRIPTION	AIR TECHNIQUES	APOLLO/ MIDMARK®	DENTALEZ®/ CUSTOM AIR/RAMVAC	MATRX/ MIDMARK®	MDT McKESSON	MIDMARK®	PELTON & CRANE	TECH WEST
CMP061	THERMAL PROTECTOR ASSEMBLY	66504	HCA30615	No OEM Part # Available	61894802	3-08-0229-10	61894802		KOPC-230
CMP062	THERMAL PROTECTOR ASSEMBLY	62504	HCA30610	No OEM Part # Available	61894801	3-08-0228-10	61894801		KOPC-115
CMP063	THERMAL PROTECTOR ASSEMBLY	64503	HCA30605			3-08-0231-10			
CMP064	THERMAL PROTECTOR ASSEMBLY	64503	HCA30600			3-08-0227-10			
CMP204	THERMAL PROTECTOR ASSEMBLY	No OEM Part # Available							
CMP206	THERMAL PROTECTOR ASSEMBLY	No OEM Part # Available							
CMP207	THERMAL PROTECTOR ASSEMBLY	No OEM Part # Available							
CMP244	THERMAL PROTECTOR ASSEMBLY	85273							
PCP641	THERMAL PROTECTOR ASSEMBLY							005110	

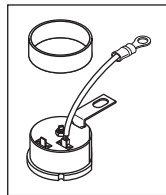

RPI Part #CMP061
OEM Part #'s -
See Chart Above

THERMAL PROTECTOR ASSEMBLY

- For use with 1HP 208-230VAC or 1HP 230VAC Compressor Heads
- Automatic reset; Includes: Protector clamp
- Opens at 135°C ± 5°C; Closes at 57°C ± 9°C
- 80A @ 120VAC; 60A @ 240VAC

Fits: Compressor Head Terminal Box

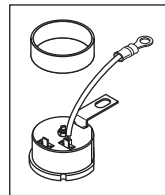

RPI Part #CMP064
OEM Part #'s -
See Chart Above

THERMAL PROTECTOR ASSEMBLY

- For use with 3/4HP 115VAC Compressor Heads
- Automatic reset; Includes: Protector clamp
- Opens at 120°C ± 5°C; Closes at 69°C ± 9°C
- 40A @ 120VAC; 30A @ 240VAC

Fits: Compressor Head Terminal Box

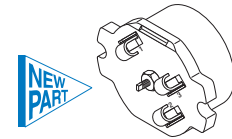

RPI Part #CMP207
OEM Part #'s -
See Chart Above



THERMAL PROTECTOR ASSEMBLY

- Automatic reset
- Opens at 135°C ± 5°C; Closes at 102°C ± 9°C
- 80A @ 120VAC; 60A @ 240VAC
- **Important Note:** For use on dual headed AirStar® 40 compressors. (For single headed AirStar® 40 compressors use Thermal Protector Assembly (RPI Part #CMP206))

Fits: Compressor Head Terminal Box

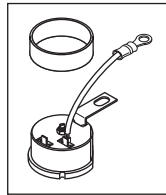

RPI Part #CMP062
OEM Part #'s -
See Chart Above

THERMAL PROTECTOR ASSEMBLY

- For use with 1HP 115VAC Compressor Heads
- Automatic reset; Includes: Protector clamp
- Opens at 120°C ± 5°C; Closes at 78°C ± 9°C
- 80A @ 120VAC; 60A @ 240VAC

Fits: Compressor Head Terminal Box

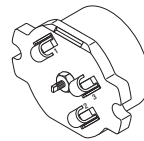

RPI Part #CMP204
OEM Part #'s -
See Chart Above

THERMAL PROTECTOR ASSEMBLY

- Automatic reset
- Opens at 150°C ± 5°C; Closes at 115°C ± 9°C
- 80A @ 120VAC; 60A @ 240VAC

Fits: Compressor Head Terminal Box

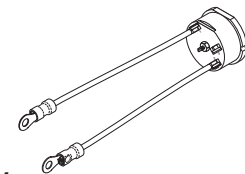

RPI Part #CMP244
OEM Part #'s - See Chart Above

THERMAL PROTECTOR ASSEMBLY

- Automatic reset
- Opens at 90°C ± 5°C; Closes at 57°C ± 9°C
- 80A @ 120VAC; 60A @ 240VAC

• 5" lg. wires with #10 ring terminals
Fits: Compressor Head Terminal Box

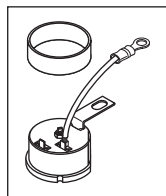

RPI Part #CMP063
OEM Part #'s -
See Chart Above

THERMAL PROTECTOR ASSEMBLY

- For use with 3/4HP 208-230VAC or 3/4HP 230VAC Compressor Heads
- Automatic reset; Includes: Protector clamp
- Opens at 105°C ± 5°C; Closes at 61°C ± 9°C
- 40A @ 120VAC; 30A @ 240VAC

Fits: Compressor Head Terminal Box

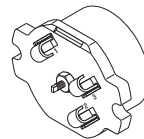

RPI Part #CMP206
OEM Part #'s -
See Chart Above

THERMAL PROTECTOR ASSEMBLY

- Automatic reset
- Opens at 135°C ± 5°C; Closes at 102°C ± 9°C
- 80A @ 120VAC; 60A @ 240VAC
- **Important Note:** For use on single headed AirStar® 40 compressors. (For dual headed AirStar® 40 compressors use Thermal Protector Assembly (RPI Part #CMP207))

Fits: Compressor Head Terminal Box

RPI Part #PCP641
OEM Part #'s -
See Chart Above

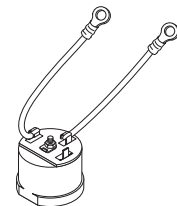

THERMAL PROTECTOR ASSEMBLY

- Automatic reset
- Opens at 120°C; Closes at 92°C
- 80A @ 120VAC; 60A @ 240VAC

• 5" lg. wires with #10 ring terminals
Fits: Compressor Head Terminal Box

Air Techniques, Apollo/Midmark®, MDT McKesson, DentalEZ®/Custom Air/RamVac, Jun-Air, Matrix/Midmark®, Midmark®, Pelton & Crane, and Tech West/Turbine Ind.

TOOLS - GREASE GUN & ACCESSORIES FOR SCROLL COMPRESSORS

RPI PART #	DESCRIPTION	APOLLO/ MIDMARK®	MIDMARK®
RXG070	GREASE CARTRIDGE	RSS40645	RSS40645
RXG071	GREASE GUN	HPA30530	HPA30530
RXK069	GREASE GUN KIT	HPA30530	HPA30530
RXN072	GREASE GUN NOZZLE	HPA30530	HPA30530

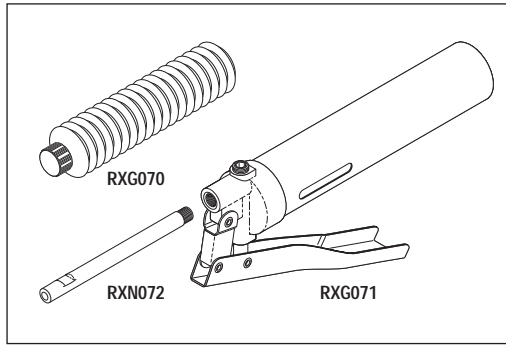

RPI Part #RXK069
OEM Part #'s - See Chart Above

GREASE GUN KIT

- OEM recommends regreasing of compressor head and motor bearings every 5,000 hours
- Includes: Grease Gun (RPI Part #RXG071), Grease Gun Nozzle (RPI Part #RXN072), and Grease Cartridge (RPI Part #RXG070)
- Used to grease the bearings in the scroll compressor head when replacing the Tip Seal Kit (RPI Part #CMK287) and/or Compressor PM & Tip Seal Kit (RPI Part #CMK286)

Fits: Scroll Compressor Head



RPI Part #RXG070
OEM Part #'s - See Chart Above

GREASE CARTRIDGE

- 2.8 oz. (80 g) cartridge
- Also included in Tip Seal Kit (RPI Part #CMK287) and/or Compressor PM & Tip Seal Kit (RPI Part #CMK286)



RPI Part #RXG071
OEM Part #'s - See Chart Above

GREASE GUN



RPI Part #RXN072
OEM Part #'s - See Chart Above

GREASE GUN NOZZLE

SERVICE TIP: Regrease the compressor head and motor bearings every 5,000 hours!

- The RPI Grease Gun Kit (RPI Part #RXK069) is the perfect tool to grease the OS (Orbital Scroll) side matched angular ball bearings and the internal crankshaft roller bearing on scroll compressor heads. Be sure to lubricate all four grease nipples (zerk fittings) as shown below, three places on the OS (Orbital Scroll) side and one located in the sight hole on the plastic dust proof cap.
- Used to grease the bearings in the scroll compressor head when replacing the Tip Seal Kit (RPI Part #CMK287) and/or Compressor PM & Tip Seal Kit (RPI Part #CMK286)

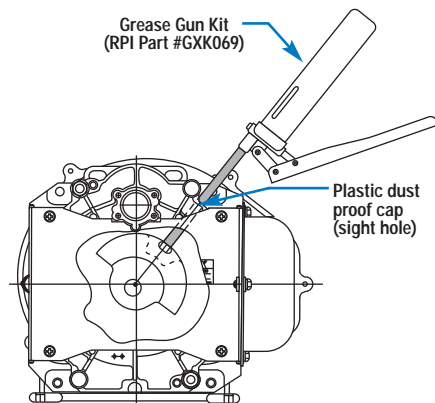
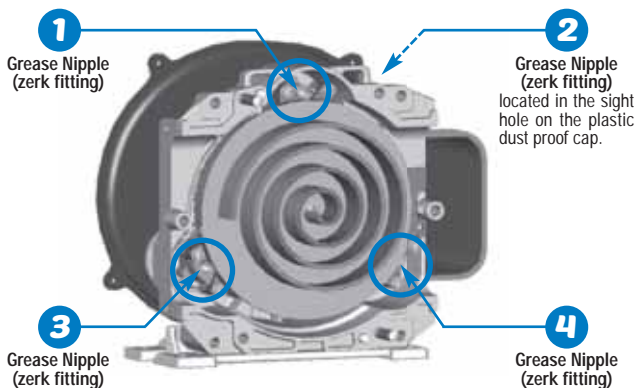

TUBING & ACCESSORIES

RPI PART #	DESCRIPTION	AIR TECHNIQUES	APOLLO/MIDMARK®	JUN-AIR	MATRIX/MIDMARK®	MIDMARK®	TECH WEST
CMT221	TUBING (10mm OD BLACK)	86726					
CMT222	TUBING (12mm OD BLACK)	86727					
RPT276	TUBING (1/4" OD CLEAR POLY)		No OEM Part # Available		No OEM Part # Available	No OEM Part # Available	No OEM Part # Available
RPT380	TUBING (.170" ID x 1/4" OD NATURAL)	89948					
RPT441	PVC TUBING - CLEAR		Included in 86727				
RPT604	TUBING (1/4" ID CLEAR PVC)		No OEM Part # Available		No OEM Part # Available	No OEM Part # Available	No OEM Part # Available
RPT670	TUBING (4mm ID x 6mm OD BLACK)			No OEM Part # Available			
RPT849	TUBING (5/16" ID x 7/16" OD CLEAR) <i>Not shown on this page - see Page 430</i>		No OEM Part # Available		No OEM Part # Available	No OEM Part # Available	No OEM Part # Available
RPT940	TUBING (1/16" ID x 1/8" OD CLEAR)	No OEM Part # Available					
RXT017	TUBING (6.5mm ID x 10mm OD BLACK)	86726					
RXT018	TUBING (8mm ID x 12mm OD BLACK)	86727					
RXT019	TUBING (.275" ID x 3/8" OD NATURAL)	89955					

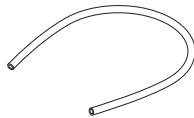

RPI Part #CMT221
OEM Part #'s - See Chart Above

TUBING (10mm OD BLACK)
 • Material: Flame retardant and weld spatter resistant polyurethane (Equiv. to Flamex®)
 • Size: 20" lg.
 • Tubing is also sold by the foot (RPI Part #RXT017)
Fits: Cooler Assembly to Membrane Dryer, 10mm Push-In Fittings

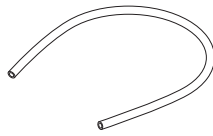

RPI Part #CMT222
OEM Part #'s - See Chart Above

TUBING (12mm OD BLACK)
 • Material: Flame retardant and weld spatter resistant polyurethane (Equiv. to Flamex®)
 • Size: 28" lg.
 • Tubing is also sold by the foot (RPI Part #RXT018)
Fits: Membrane Dryer to Tank, 12mm Push-In Fittings

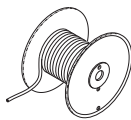

RPI Part #RPT276
OEM Part #'s - See Chart Above

TUBING (5/32" ID x 1/4" OD CLEAR)
 • Sold by the foot (reel not included)
 • Material: Polyurethane
 • Included in: Collection Container Kit (RPI Part #CMK181) and Syringe Pump/Extractor (RPI Part #RPT842)
Fits: 5/32" Barbs or 1/4" Push-In Fittings

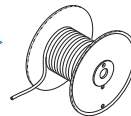

RPI Part #RPT380
OEM Part #'s - See Chart Above

TUBING (.170" ID x 1/4" OD NATURAL)
 • Sold by the foot (reel not included)
 • Material: Nylon®
Fits: 1/4" Push-In Fittings

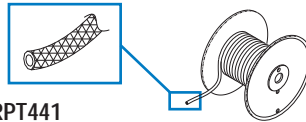

RPI Part #RPT441
OEM Part #'s - See Chart Above

TUBING (.50" ID x .73" OD CLEAR/BRAIDED)
 • Sold by the foot (reel not included)
 • Replacement tubing included in Fresh Air Intake Filter Kit (RPI Part #CMK003)
Fits: 1/2" Barbs

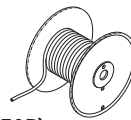

RPI Part #RPT604
OEM Part #'s - See Chart Above

TUBING (1/4" ID x 3/8" OD CLEAR)
 • Sold by the foot (reel not included)
 • Material: Clear flexible PVC
 • Included in: Collection Container Kit (RPI Part #'s CMK180 & CMK181)
Fits: 1/4" Barbs or 3/8" Push-In Fittings

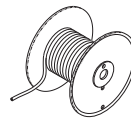

RPI Part #RPT670
OEM Part #'s - See Chart Above

TUBING (4mm ID x 6mm OD BLACK)
 • Sold by the foot (reel not included)
 • Polyurethane tubing - black
 • Included in: Pressure Switch (RPI Part #CMS055)
Fits: 4mm Barbs or 6mm Push-In Fittings

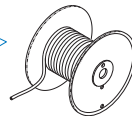

RPI Part #RPT940
OEM Part #'s - See Chart Above

TUBING (1/16" ID x 1/8" OD CLEAR)
 • Sold by the foot (reel not included)
 • Material: Polyurethane
 • Included in: Orifice Assemblies (RPI Part #'s CMA245, CMA246, CMA252 & CMA253)
Fits: 1/16" Barbs

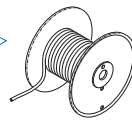

RPI Part #RXT017
OEM Part #'s - See Chart Above

TUBING (6.5mm ID x 10mm OD BLACK)
 • Sold by the foot (reel not included)
 • Material: Flame retardant and weld spatter resistant polyurethane (Equiv. to Flamex®)
Fits: 10mm Push-In Fittings

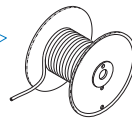

RPI Part #RXT018
OEM Part #'s - See Chart Above

TUBING (8mm ID x 12mm OD BLACK)
 • Sold by the foot (reel not included)
 • Material: Flame retardant and weld spatter resistant polyurethane (Equiv. to Flamex®)
Fits: 12mm Push-In Fittings

RPI Part #RXT019
OEM Part #'s - See Chart Above

TUBING (.275" ID x 3/8" OD NATURAL)
 • Sold by the foot (reel not included)
 • Material: Nylon®
 • Included in: Check Valve Upgrade Kit (RPI Part #'s CMK247, CMK248 & CMK249)
Fits: 3/8" Push-In Fittings

UNLOADER VALVES

RPI PART #	DESCRIPTION	AIR TECHNIQUES	APOLLO/MIDMARK®	JUN-AIR	MDT McKESSON
CMV121	UNLOADER VALVE Also available: Unloader Valve Repair Kit (RPI Part #CMK122)	60030	ACA85966		
CMK122	UNLOADER VALVE REPAIR KIT Also available: Unloader Valve (RPI Part #CMV121)	No OEM Part # Available	No OEM Part # Available		
RPF826	ADAPTOR (3/8 FPT x 1/2 MPT) - 2/pkg Included in: Unloader Valve (RPI Part #CMV121)	No OEM Part # Available	No OEM Part # Available		
RPF827	MALE CONNECTOR - 2/pkg Included in: Unloader Valve (RPI Part #CMV121)	No OEM Part # Available	No OEM Part # Available		
RPF828	ADAPTOR (1/4 MPT x 3/8 MPT) - 2/pkg Included in: Unloader Valve (RPI Part #CMV121)	No OEM Part # Available	No OEM Part # Available		
CMV123	UNLOADER VALVE Also available: Unloader Valve Repair Kit (RPI Part #CMK124)				3-08-0308-10
CMK124	UNLOADER VALVE REPAIR KIT Also available: Unloader Valve (RPI Part #CMV123)				No OEM Part # Available
RPF662	MALE CONNECTOR Included in: Unloader Valve (RPI Part #CMV123)				No OEM Part # Available
CMV058	UNLOADER VALVE Also available: Pressure Switch (RPI Part #CMS055)			JA6973300	

RPI Part #CMV121
OEM Part #'s - See Chart Above

UNLOADER VALVE

- Quick exhaust valve with (2) 1/4" FPT ports and (1) 3/8" FPT exhaust port
- Material: Aluminum body and Buna N diaphragm
- Includes all parts as shown
- Also available: Unloader Valve Repair Kit (RPI Part CMK122), 1/4" Teflon Thread Sealing Tape (RPI Part #RPT579), and Copper Tubing (RPI Part #RPT547)

Fits: Desiccant Tank

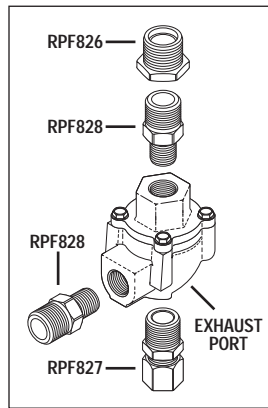

RPI Part #CMK122
OEM Part #'s - See Chart Above

UNLOADER VALVE REPAIR KIT

- Includes: Valve seal, O-ring, and mounting screws

Fits: Unloader Valve (RPI Part #CMV121) only

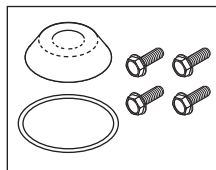

RPI Part #RPF826
OEM Part #'s - See Chart Above

ADAPTOR (3/8" FPT x 1/2" MPT)

- 2 per package
- Material: Brass
- Included in: Unloader Valve (RPI Part #CMV121)

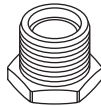

RPI Part #RPF827
OEM Part #'s - See Chart Above

MALE CONNECTOR (3/8" TUBE x 3/8" MPT)

- 2 per package
- Material: Brass
- Included in: Unloader Valve (RPI Part #CMV121)

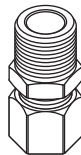

RPI Part #RPF828
OEM Part #'s - See Chart Above

ADAPTOR (1/4" MPT x 3/8" MPT)

- 2 per package
- Material: Brass
- Included in: Unloader Valve (RPI Part #CMV121)

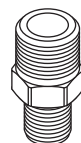

RPI Part #CMV123
OEM Part #'s - See Chart Above

UNLOADER VALVE

- Quick exhaust valve with (3) 1/4" FPT ports
- Material: Aluminum body
- Includes all parts as shown
- Also available: Unloader Valve Repair Kit (RPI Part #CMK124), 1/4" Teflon Thread Sealing Tape (RPI Part #RPT579), and Copper Tubing (RPI Part #RPT547)

Fits: Desiccant Tanks (MDT McKesson Part #3-08-0729-20 & 3-08-0800-30)

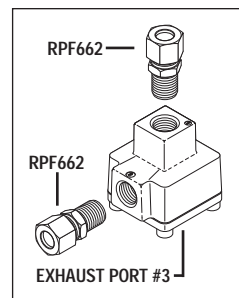

RPI Part #CMK124
OEM Part #'s - See Chart Above

UNLOADER VALVE REPAIR KIT

- Includes: Valve disk, and O-ring
- Also available: Unloader Valve (RPI Part #CMV123)

Fits: Unloader Valve

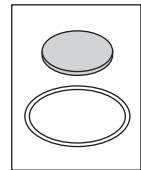

RPI Part #RPF662
OEM Part #'s - See Chart Above

MALE CONNECTOR (3/8" TUBE x 1/4" MPT)

- Material: Brass
- Includes: Compression Nut (RPI Part #RPF222) and Compression Sleeve (RPI Part #RPF218)
- Included in: Collection Container Kit (RPI Part #CMK180), and Unloader Valve (RPI Part #CMV123)

Fits: Collection Container Kit, and Unloader Valve



RPI Part #CMV058
OEM Part #'s - See Chart Above

UNLOADER VALVE

- Plastic body; 1/8" BSP
- 4mm barb fitting
- Included in: Pressure Switch (RPI Part #CMS055)

Fits: Pressure Switch

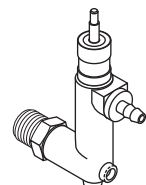

Models: DV5, DV7, DV10, DV12, SC3, SC5, SC7, SC10, & SC12

New PM Kits to fit

**A-dec®/Dean®
Dental Compressors
and Dental Vacuum Units!**

PM Kits to fit A-dec/Dean Dental Compressors

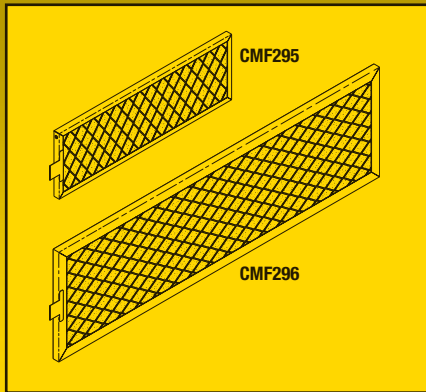

RPI Part #CMK293
OEM Part #A0050

COMPRESSOR PM KIT

- For Oil-less dual, triple and quad headed compressors
- All parts also sold separately
- Includes all parts as shown plus a PM Sticker and PM checklist
- See *the RPI Advantage* below

Fits: Compressor Body
Models: SC3, SC5 & SC7

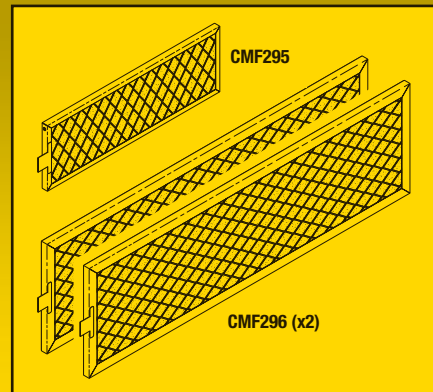

RPI Part #CMK294
OEM Part #A0150

COMPRESSOR PM KIT

- For Oil-less 5 and 6 headed compressors
- All parts also sold separately
- Includes all parts as shown plus a PM Sticker and PM checklist
- See *the RPI Advantage* below

Fits: Compressor Body
Models: SC10 & SC12

PM Kit to fit A-dec/Dean Dental Vacuum Units



RPI Part #VPK183
OEM Part #A0049

VACUUM PM KIT

- **Service Tip:** Air filter life depends on vacuum usage, nature of environment, and amount of aspirated material. Inspect air filter every 1,000 hours and replace every 2,000 hours or when visibly dirty.
- All parts also sold separately
- Includes all parts as shown plus a PM Sticker and PM checklist
- See *the RPI Advantage* below

Fits: Inside Separator Tank and Drain Assembly
Models: DV5, DV7, DV10 & DV12

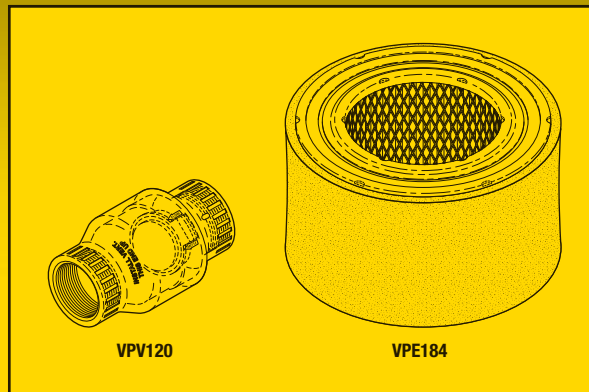

RPI Filters and PM Kits include a PM Sticker that can be attached to the compressor or vacuum unit for recording the date that the filters were replaced. It's the RPI Advantage!



replacement parts industries, inc.

CALL (800) 221-9723 • FAX (818) 882-7028 • EMAIL order@riparts.com • WEBSITE www.riparts.com

The above parts are manufactured by Replacement Parts Industries, Inc. to fit the equipment noted. All product names used in this document are trademarks or registered trademarks of their respective holders. 2010AD Show 02/21

Air Filters to fit A-dec/Dean Dental Compressors!

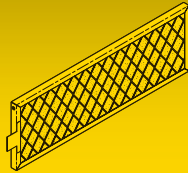

RPI Part #CMF295

OEM Part # (OEM Part # Not Available)

AIR FILTER

- Size: 9.87" lg. x 3.25" wide
- Material: 60 PPI Quadrafoam, color black, aluminum frame and stainless steel mesh
- Included in: Compressor PM Kit (RPI Part #CMK293) and Compressor PM Kit (RPI Part #CMK294)
- See *the RPI Advantage* on reverse side

Fits: Compressor Body

Models: SC3, SC5, SC7, SC10 & SC12

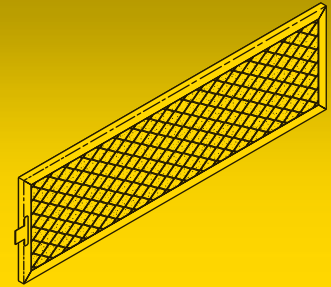

RPI Part #CMF296

OEM Part # (OEM Part # Not Available)

AIR FILTER

- Size: 18.44" lg. x 5.44" wide
- Material: 25 PPI Quadrafoam, color green, aluminum frame and stainless steel mesh
- Included in: Compressor PM Kit (RPI Part #CMK293) and Compressor PM Kit (RPI Part #CMK294)
- See *the RPI Advantage* on reverse side

Fits: Compressor Body

Models: SC3, SC5, SC7, SC10 & SC12

New Parts to fit A-dec/Dean Dental Compressors & Vacuums!

ADDRESS SERVICES REQUESTED

PERMIT NO. 2399
VAN NUYS, CA
U.S. POSTAGE PAID
PRESORTED STANDARD

625 Cochran Street • Simi Valley, California • 93065
replacement parts industries, inc.



Parts to fit A-dec/Dean Dental Vacuum Units!

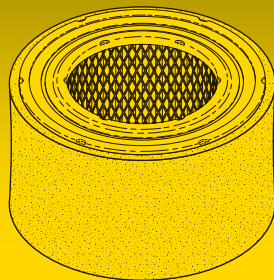

RPI Part #VPE184

OEM Part # (OEM Part # Not Available)

FILTER ELEMENT

- 5 micron
- Size 7.88" OD x 4.81" lg.
- Included in: Vacuum PM Kit (RPI Part #VPK183)
- See *the RPI Advantage* on reverse side

Fits: Inside Separator Tank

Models: DV5, DV7, DV10 & DV12

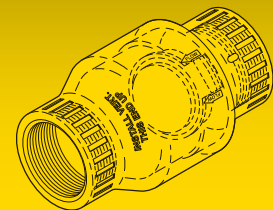

RPI Part #VPV120

OEM Part # (OEM Part # Not Available)

CHECK VALVE (1-1/2")

- Ports: 1-1/2" FPT
- Material: Clear PVC
- Size: 3.38" dia. x 5.75" lg.
- Included in: Vacuum PM Kit (RPI Part #VPK183)

Fits: Inside Separator Tank and Drain Assembly

Models: DV5, DV7, DV10 & DV12

500 SERIES HANDPIECE CONTROL BLOCK (OEM Part #38.1776.00) Exploded View

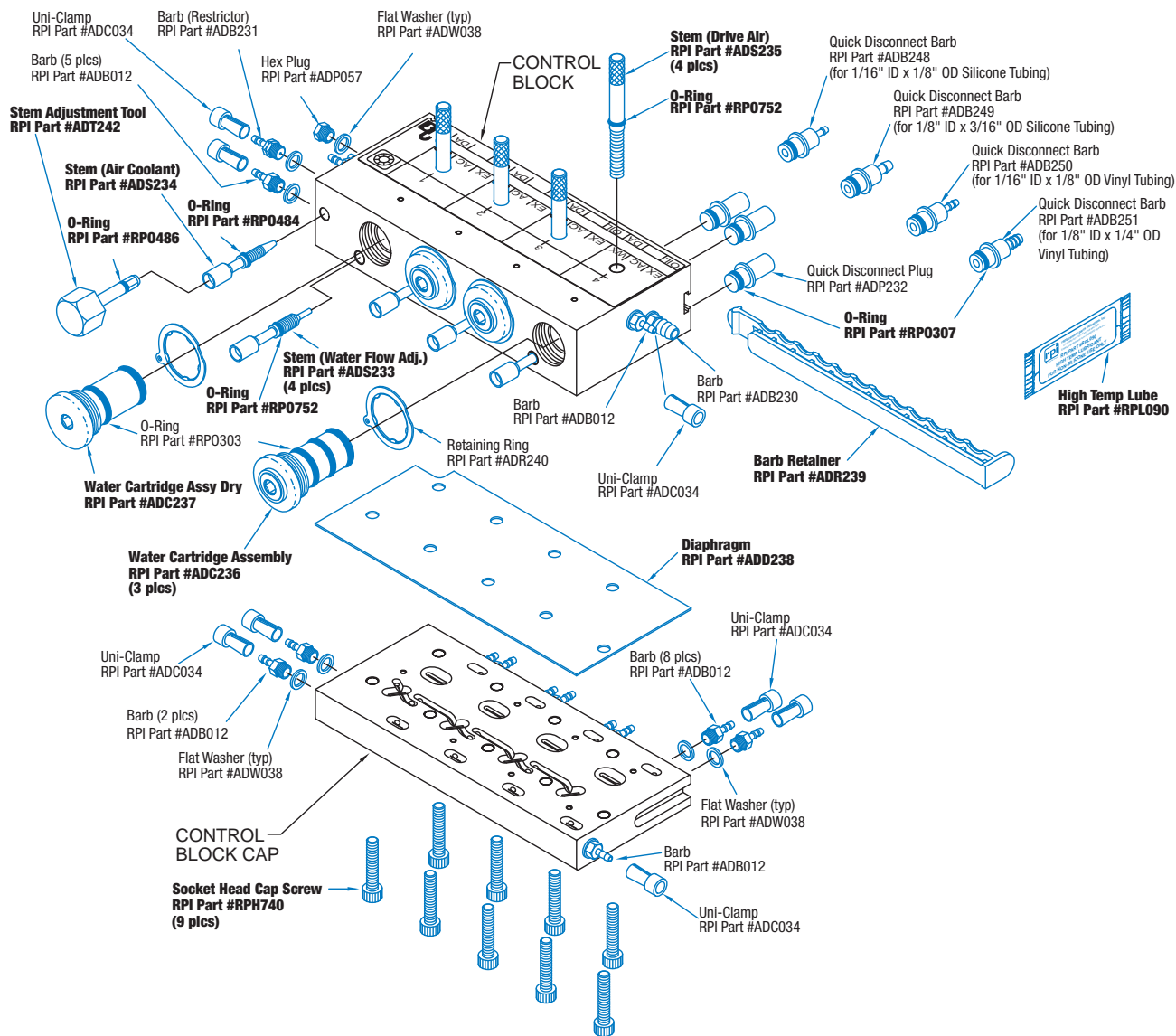

CONTROL BLOCK KIT (MINOR) RPI Part #ADK257

(Kit parts identified in bold text - All parts also sold separately)

For simple repairs to the Control Block – like air and water leaks – this unique Kit includes repair parts such as cartridge assemblies, diaphragm, stems, and o-rings. Right at your fingertips!

**FOR DETAILS ABOUT THIS KIT,
SEE PAGE 501**



CONTROL BLOCK KIT (MAJOR) RPI Part #ADK241

(Kit includes all parts shown in blue - All parts also sold separately)

With this Kit, you can easily replace any of the Control Block parts, or completely rebuild the Control Block. Save money and time with this Kit!

**FOR DETAILS ABOUT THIS KIT,
SEE PAGE 502**

Dental Equipment

Handpiece Control Block 300 Series (OEM Part #38.1831.00) & 500 Series (OEM Part #38.1776.00) (continued)



RPI Part #ADK257
OEM Part #38.1776.00 (Block Assy.)

CONTROL BLOCK KIT (MINOR)

- Kit includes Storage Case (RPI Part #RPC753)
- All parts also sold separately in quantities indicated below

Models: Handpiece Control Block 300 Series* (OEM Part #38.1831.00) & 500 Series (OEM Part #38.1776.00)

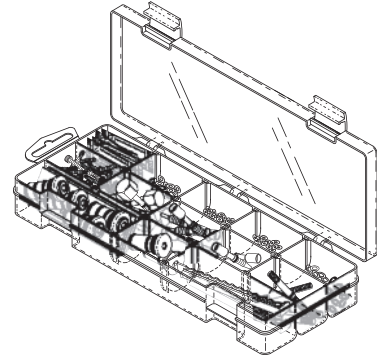

For simple repairs to the Control Block – like air and water leaks – this unique Kit includes repair parts such as cartridge assemblies, diaphragm, stems, and o-rings. Right at your fingertips!

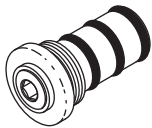

ADC236

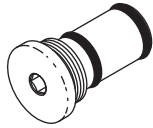

ADC237

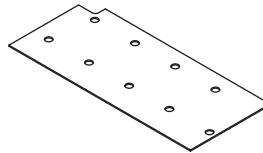

ADD238

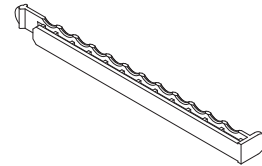

ADR239

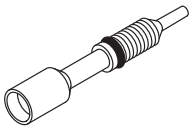

ADS233

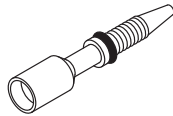

ADS234

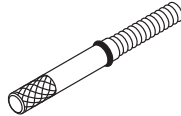

ADS235

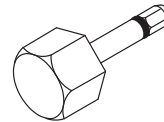

ADT242

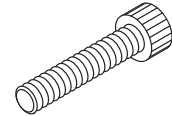

RPH740



RPL090



RPO307
Shown
Actual Size



RPO484
Shown
Actual Size



RPO486
Shown
Actual Size



RPO752
Shown
Actual Size

RPI PART #	OEM PART #	DESCRIPTION	KIT QTY	REORDER QTY (PER PKG)	Fits Control Block 300 SERIES (OEM #38.1831.00)	Fits Control Block 500 SERIES (OEM #38.1776.00)
ADC236	38.1780.00	WATER CARTRIDGE ASSEMBLY	4	1	•	•
ADC237	38.1783.00	WATER CARTRIDGE ASSY DRY	2	1	•	•
ADD238	38.1787.01	DIAPHRAGM	5	5		•
ADR239	38.1800.00	BARB RETAINER	2	1		•
ADS233	38.0516.00	STEM (WATER FLOW ADJ.)	4	1		•
ADS234	38.0526.00	STEM (AIR COOLANT)	2	1		•
ADS235	38.1785.01	STEM (DRIVE AIR)	4	1	•	•
ADT242	38.1808.01 & 98.0867.02	STEM ADJUSTMENT TOOL	5	5		•
RPH740	001.240.00	SOCKET HEAD CAP SCREW	25	25	•	•
RPL090	98.0090.01	HIGH TEMP LUBRICANT	5	5	•	•
RPO307	030.006.02	O-RING	12	12	•	•
RPO484	030.003.01	O-RING	12	12	•	•
RPO486	034.002.01	O-RING	12	12		•
RPO752	035.034.01	O-RING	12	12	•	•

* All parts in this kit fit the Control Block 300 series (OEM Part #38.1831.00) with the exception of the following parts: Diaphragm (RPI Part #ADD238), Barb Retainer (RPI Part #ADR239), Stem (Water Flow Adj.) (RPI Part #ADS233), Stem (Air Coolant) (RPI Part #ADS234), Stem Adjustment Tool (RPI Part #ADT242), and O-Ring (RPI Part #RPO486).



RPI Part #ADK241
OEM Part #38.1776.00 (Block Assy.)

CONTROL BLOCK KIT (MAJOR)

- Kit includes Storage Case (RPI Part #RPC751)
 - All parts also sold separately in quantities indicated below
- Models:** Handpiece Control Block 300 Series* (OEM Part #38.1831.00) & 500 Series (OEM Part #38.1776.00)

With this Kit, you can easily replace any of the Control Block parts, or completely rebuild the Control Block. Save money and time with this Kit!

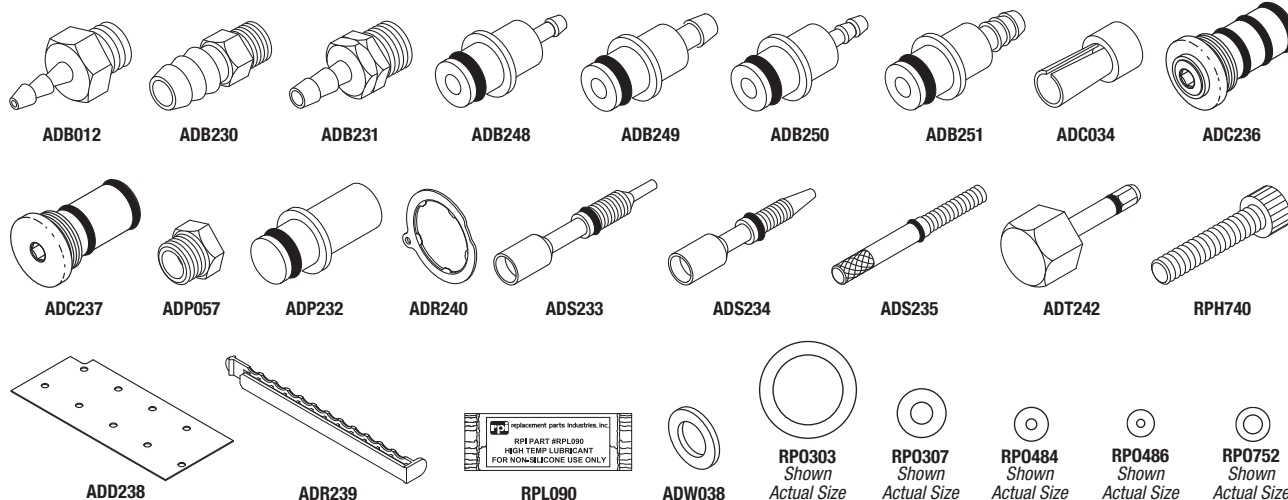
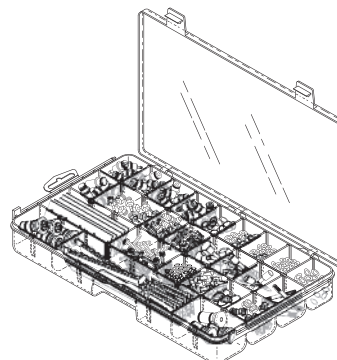

RPI PART #	OEM PART #	DESCRIPTION	KIT QTY	REORDER QTY (PER PKG)	Fits Control Block 300 SERIES (OEM #38.1831.00)	Fits Control Block 500 SERIES (OEM #38.1776.00)
ADB012	023-004-01 & 023.004.03	BARB	10	10	•	•
ADB230	023.505.01	BARB	10	10	•	•
ADB231	023.811.00	BARB (RESTRICTOR)	10	10	•	•
ADB248	026.174.01	QUICK DISCONNECT BARB 1/8" SILICONE	5	5	•	•
ADB249	026.175.01	QUICK DISCONNECT BARB 3/16" SILICONE	5	5	•	•
ADB250	026.161.00	QUICK DISCONNECT BARB 1/8" VINYL	5	5	•	•
ADB251	026.088.00	QUICK DISCONNECT BARB 1/4" VINYL	5	5	•	•
ADC034	025.007.01	UNI-CLAMP	20	20	•	•
ADC236	38.1780.00	WATER CARTRIDGE ASSEMBLY	4	1	•	•
ADC237	38.1783.00	WATER CARTRIDGE ASSY DRY	3	1	•	•
ADD238	38.1787.01	DIAPHRAGM	5	5	•	•
ADP057	021.016.01 & 021.016.00	HEX PLUG	10	10	•	•
ADP232	026.160.01	QUICK DISCONNECT PLUG	5	5	•	•
ADR239	38.1800.00	BARB RETAINER	3	1	•	•
ADR240	38.1779.01	RETAINING RING	5	5	•	•
ADS233	38.0516.00	STEM (WATER FLOW ADJ.)	4	1	•	•
ADS234	38.0526.00	STEM (AIR COOLANT)	2	1	•	•
ADS235	38.1785.01	STEM (DRIVE AIR)	4	1	•	•
ADT242	38.1808.01 & 98.0867.02	STEM ADJUSTMENT TOOL	5	5	•	•
ADW038	004-005-00	FLAT WASHER	50	50	•	•
RPH740	001.240.00	SOCKET HEAD CAP SCREW	25	25	•	•
RPL090	98.0090.01	HIGH TEMP LUBRICANT	5	5	•	•
RPO303	030.012.01	O-RING	12	12	•	•
RPO307	030.006.02	O-RING	12	12	•	•
RPO484	030.003.01	O-RING	12	12	•	•
RPO486	034.002.01	O-RING	12	12	•	•
RPO752	035.034.01	O-RING	12	12	•	•

* All parts in this kit fit the Control Block 300 series (OEM Part #38.1831.00) with the exception of the following parts: Diaphragm (RPI Part #ADD238), Barb Retainer (RPI Part #ADR239), Stem (Water Flow Adj.) (RPI Part #ADS233), Stem (Air Coolant) (RPI Part #ADS234), Stem Adjustment Tool (RPI Part #ADT242), and O-Ring (RPI Part #RPO486).

Dental Equipment

Handpiece Control Block Century Plus (OEM Part #38.0540.00)

CENTURY PLUS HANDPIECE CONTROL BLOCK (OEM Part #38.0540.00)

Exploded View

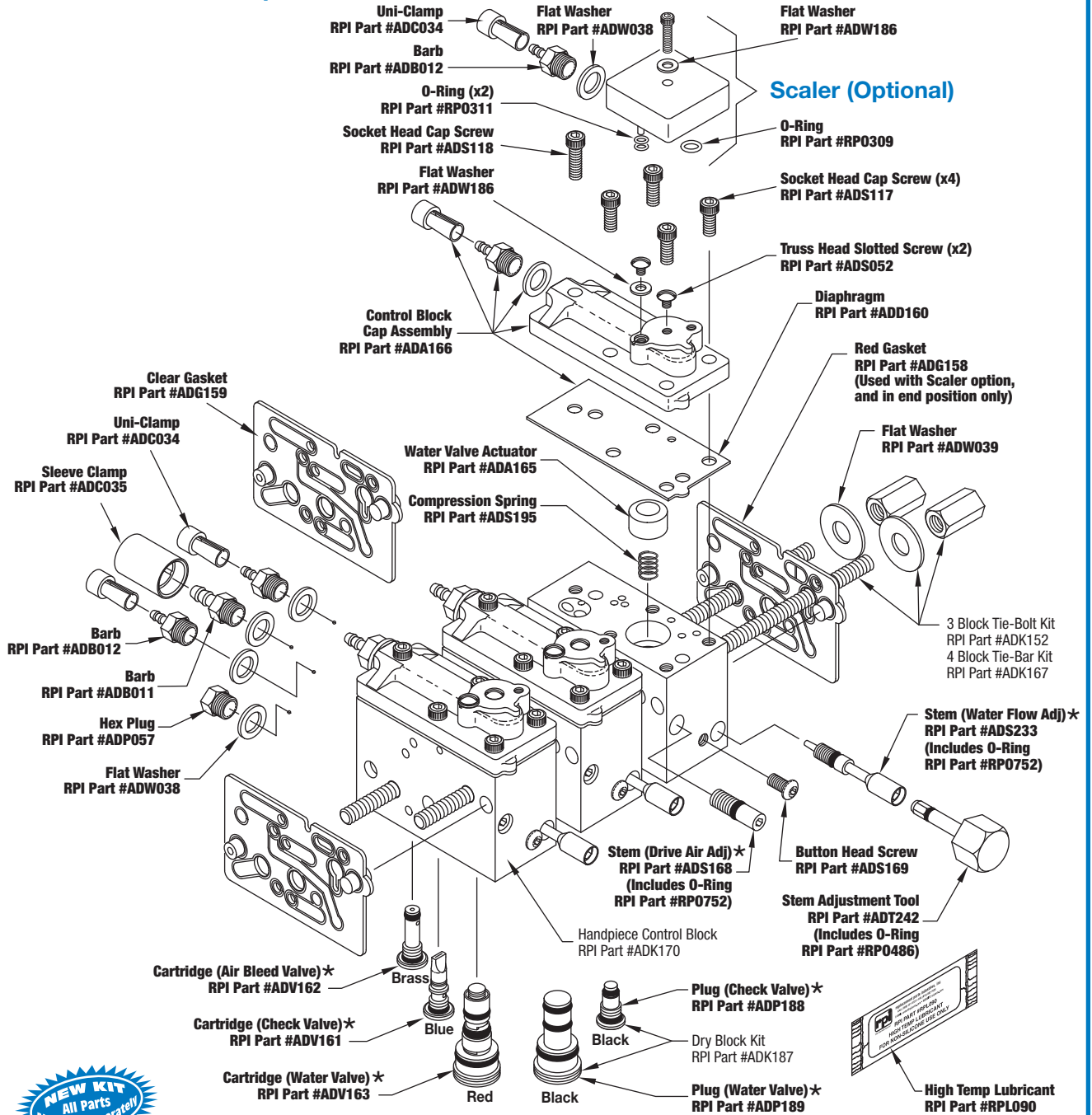

NEW KIT
All Parts
Also Sold Separately

* Apply a thin coat of High Temp Lubricant (RPI Part #RPL090) onto O-rings in Stems & Cartridges prior to assembly.

CONTROL BLOCK KIT (MAJOR)

RPI Part #ADK190

(Kit parts identified in bold text - All parts also sold separately)

With this Kit, you can easily replace Handpiece Control Block parts, or completely rebuild the Control Block. Save money and time with this Kit!

**FOR DETAILS ABOUT THIS KIT,
SEE PAGE 504**



RPI Part #ADK190

OEM Part # (No OEM Part # Available)

CONTROL BLOCK KIT (MAJOR)

- Kit includes Storage Case (RPI Part #RPC751)
- All parts also sold separately in quantities indicated below

Model: Handpiece Control Block Century Plus (OEM Part #38.0540.00)

With this Kit, you can easily replace Handpiece Control Block parts, or completely rebuild the Control Block. Save money and time with this Kit!

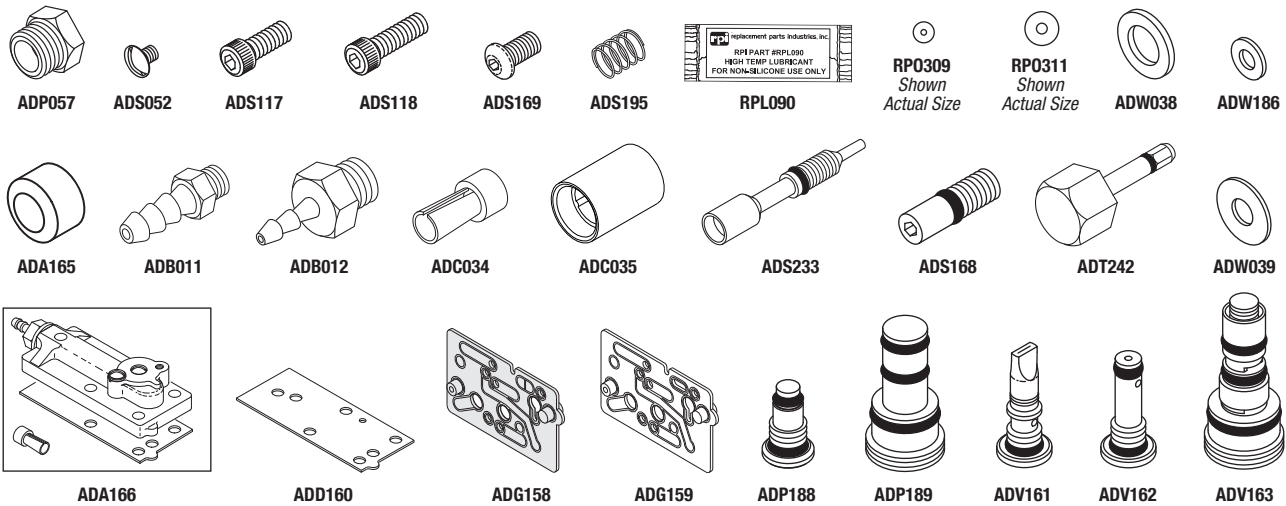
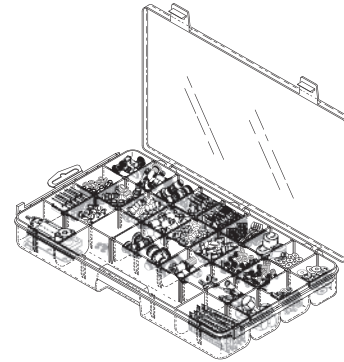

RPI PART #	OEM PART #	DESCRIPTION	KIT QTY	REORDER QTY (PER PKG)
▶ ADA165	38.0514.00	WATER VALVE ACTUATOR	3	3
▶ ADA166	38.0546.00	CONTROL BLOCK CAP ASSEMBLY	1	1
▶ ADB011	023-001-01	BARB	10	10
▶ ADB012	023-004-01 & 023.004.03	BARB	10	10
▶ ADC034	025.007.01	UNI-CLAMP	20	20
▶ ADC035	025-015-01	SLEEVE CLAMP	20	20
▶ ADD160	38-0519-01	DIAPHRAGM	10	10
▶ ADG158	38-0550-00	RED GASKET	5	5
▶ ADG159	38-0507-00	CLEAR GASKET	10	10
▶ ADP057	021-016-01 & 021.016.00	HEX PLUG	10	10
▶ ADP188	38.0646.00 & 38.0648.00 (Kit)	PLUG (CHECK VALVE)	3	3
▶ ADP189	38.0647.00 & 38.0648.00 (Kit)	PLUG (WATER VALVE)	3	3
▶ ADS052	001-002-00	TRUSS HEAD SLOTTED SCREW	10	10
▶ ADS117	001-024-00	SOCKET HEAD CAP SCREW	25	25
▶ ADS118	001-021-00	SOCKET HEAD CAP SCREW	25	25
▶ ADS168	38.0510.00	STEM (DRIVE AIR ADJ.)	3	3
▶ ADS169	002-118-00	BUTTON HEAD CAP SCREW	5	5
▶ ADS195	013-021-00	COMPRESSION SPRING	10	10
▶ ADS233	38.0516.00	STEM (WATER FLOW ADJ.)	4	1
▶ ADT242	38.1808.01 & 98.0867.02	STEM ADJUSTMENT TOOL	5	5
▶ ADV161	38-0518-00	CARTRIDGE (CHECK VALVE)	4	3
▶ ADV162	38-0517-00	CARTRIDGE (AIR BLEED VALVE)	4	3
▶ ADV163	38-0520-00	CARTRIDGE (WATER VALVE)	4	3
▶ ADW038	004-005-00	FLAT WASHER	50	50
▶ ADW039	004-036-00	FLAT WASHER	15	15
▶ ADW186	004-078-00	FLAT WASHER	5	5
▶ RPL090	98.0090.01	HIGH TEMP LUBRICANT	5	5
▶ RPO309	030-001-00	O-RING	12	12
▶ RPO311	030-003-00	O-RING	12	12

Dental Equipment

Handpiece Control Block Century Plus (OEM Part #38.0540.00) (continued)



RPI Part #ADK170
OEM Part #38.0540.00

HANDPIECE CONTROL BLOCK

- Material: Nickel plated brass
 - Includes all parts as shown
 - Also available: Control Block Service Kit (RPI Part #ADK164) and Control Block Service Kit (Major) (RPI Part #ADK190)
- Model:** Handpiece Control Block Century Plus (OEM Part 38.0540.00)

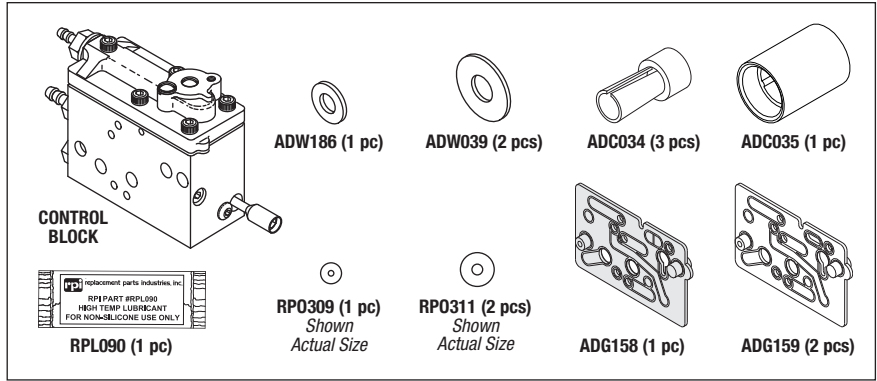

RPI Part #ADK164
OEM Part #38.0537.01

CONTROL BLOCK SERVICE KIT

- Includes all parts as shown
 - All parts also sold separately
 - Also available: Handpiece Control Block (RPI Part #ADK170) and Control Block Kit (Major) (RPI Part #ADK190)
- Model:** Handpiece Control Block Century Plus (OEM Part #38.0540.00)

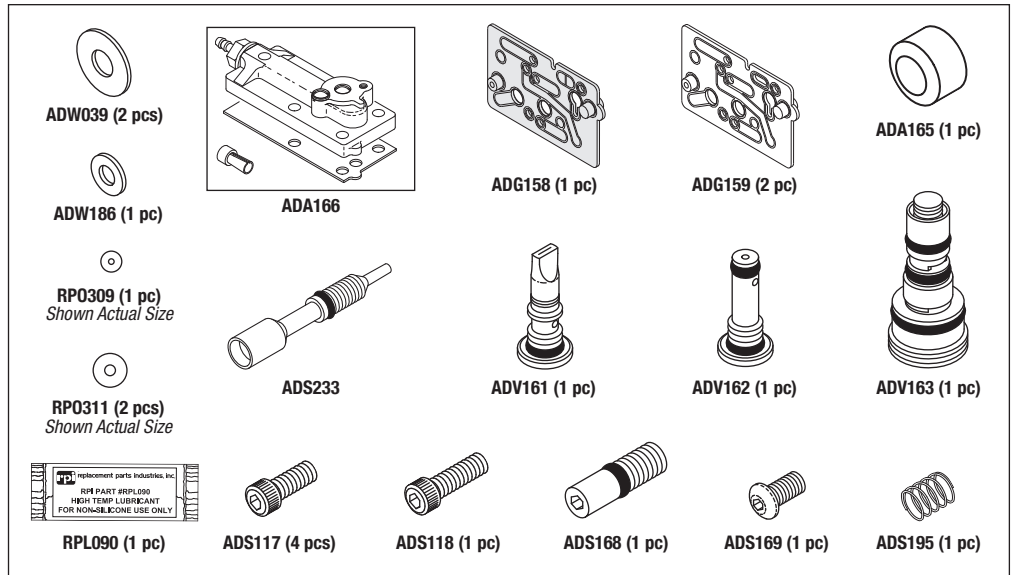

RPI Part #ADA166
OEM Part #38.0546.00

CONTROL BLOCK CAP ASSY

- Material: Nickel plated brass
 - Includes all parts as shown
 - Also included in: Control Block Kit (RPI Part #ADK164), Handpiece Control Block (RPI Part #ADK170) and Control Block Service Kit (Major) (RPI Part #ADK190)
- Model:** Handpiece Control Block Century Plus (OEM Part 38.0540.00)

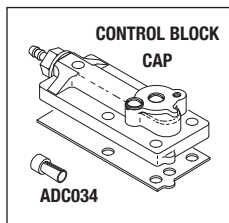

RPI Part #ADA165
OEM Part #38.0514.00

WATER VALVE ACTUATOR

- 3 per package; Material: Plastic
 - Also included in: Control Block Service Kit (RPI Part #ADK164)
 - Also available: Control Block Service Kit (Major) (RPI Part #ADK190)
- Model:** Handpiece Control Block Century Plus (OEM Part 38.0540.00)



RPI Part #ADK187
OEM Part #38.0648.00

DRY BLOCK KIT

- Material: Brass cartridges with black tops
 - Includes all parts as shown
 - Replaces: Cartridge (Water Valve) (RPI Part #ADV163) and Cartridge (Check Valve) (RPI Part #ADV161)
- Model:** Handpiece Control Block Century Plus (OEM Part 38.0540.00)

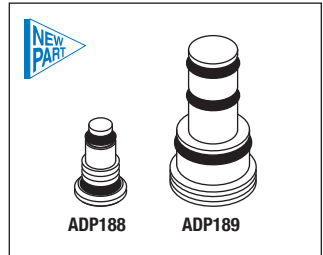

RPI Part #ADK152
OEM Part #38-0193-00

3 BLOCK TIE BOLT KIT

- Includes all parts as shown
 - (2) Kits are required
- Model:** Handpiece Control Block Century Plus (OEM Part 38.0540.00)

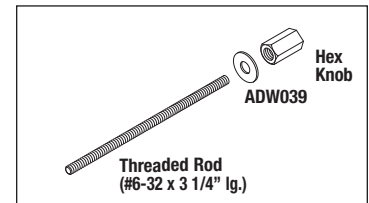

RPI Part #ADK167
OEM Part #38-0194-01 & 38-0504-08

4 BLOCK TIE BOLT KIT

- Includes all parts as shown
 - (2) Kits are required
- Model:** Handpiece Control Block Century Plus (OEM Part 38.0540.00)

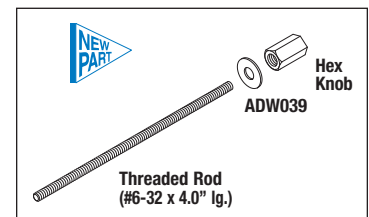

CENTURY II® HANDPIECE CONTROL BLOCK (OEM Part #38.0223.00)

Exploded View
(Kit parts identified in bold text - All parts also sold separately)

Universal Sleeve Tool
RPI Part #RPT296

Sleeve Clamp
RPI Part #ADC035

Uni-clamp (3 pcs)
RPI Part #ADC034

Barb 1/16"
RPI Part #ADB012

Barb 1/8"
RPI Part #ADB011

Washer (4 pcs)
RPI Part #ADW038

Gasket
RPI Part #ADG031

Water Cover Valve Kit
RPI Part #ADK144

Air Cover Valve Kit
RPI Part #ADK143

Set Screw (Pre-coated)
RPI Part #RPH435

Adjusting Screw
RPI Part #ADS055

Valve Stem Needle
RPI Part #ADS007

O-Ring (2 pcs)
RPI Part #RPO312

Body Knob
See page 4-507 for complete options.

Valve Core Removal/Syringe Tool
RPI Part #RPT264
(Can also be used to adjust Drive Air Screw)

CONTROL BLOCK

Also available:

Hex Ball Driver
RPI Part #RPT297

- Use to remove and install Water Cover Valve

RPI Part #ADK142
OEM Part #38-0223-00

HANDPIECE CONTROL BLOCK

- Material: Brass with nickel plating
- Includes all parts as shown

Model: Handpiece Control Block Century II (OEM Part #38.0223.00)

RPI Block includes Removable Set Screw!

RPI Handpiece Control Block includes removable Set Screw for easy access to the stem!

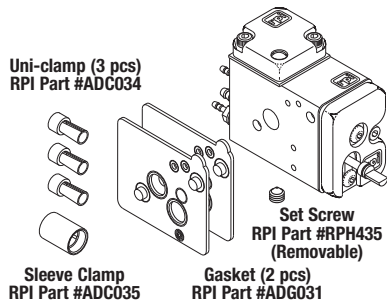

RPI Part #ADK150
OEM Part # (No OEM Part # Available)

MASTER CONTROL BLOCK KIT

- Includes all parts as shown

Model: Handpiece Control Block Century II (OEM Part #38.0223.00)

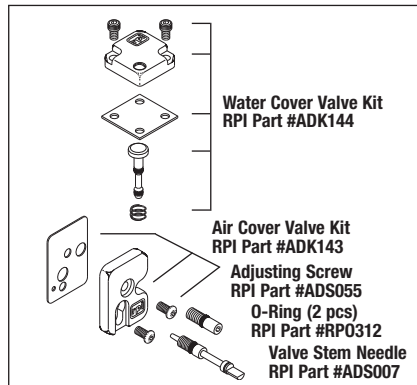

RPI Part #ADK094
OEM Part #90-0321-00

CONTROL BLOCK SERVICE KIT

- Includes all parts as shown

Model: Handpiece Control Block Century II (OEM Part #38.0223.00)

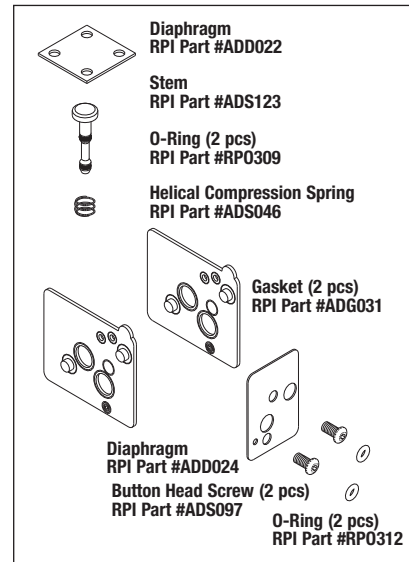

RPI Part #ADK152
OEM Part #38-0193-00

3 BLOCK TIE BOLT KIT

- Includes all parts as shown

Model: Handpiece Control Block Century II (OEM Part #38.0223.00)

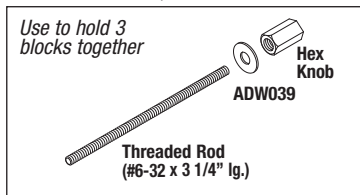

RPI Part #ADK167
OEM Part #38-0194-01 & 38-0504-08

4 BLOCK TIE BOLT KIT

- Includes all parts as shown

Model: Handpiece Control Block Century II (OEM Part #38.0223.00)

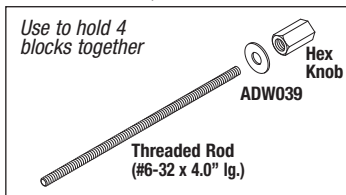

See page 4-507
for information on the
Air Cover Valve Kit and
Water Cover Valve Kit!

Dental Equipment

Handpiece Control Block Century II® (OEM Part #38.0223.00) (continued)

RPI Part #ADK143
OEM Part #90-0304-00

AIR COVER VALVE KIT

- Includes all parts as shown
- Model:** Handpiece Control Block Century II (OEM Part #38.0223.00)

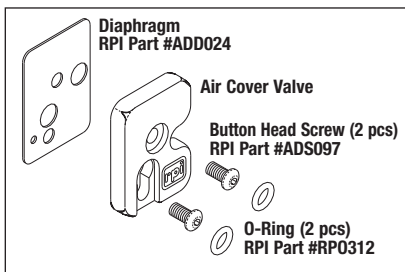

RPI Part #ADK144
OEM Part # (No OEM Part # Available)

WATER COVER VALVE KIT

- Includes all parts as shown
- Model:** Handpiece Control Block Century II (OEM Part #38.0223.00)

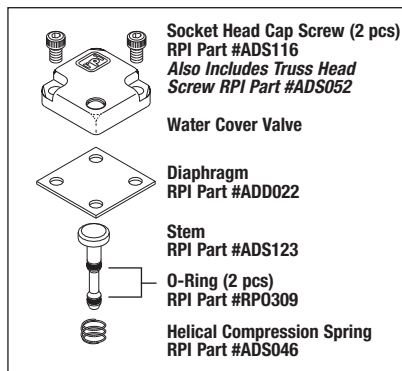

Knobs to fit Handpiece Control Block Century II® (OEM Part #38.0223.00)

RPI Part #ADK171
OEM Part # (No OEM Part # Available)

BLACK KNOB SET

- Includes all parts as shown
- 3/16" diameter "D" shaped shaft
- Fits:** Needle Valve for HPCB & Valve for Master Control Block

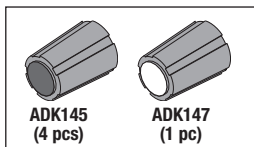

RPI Part #ADK172
OEM Part # (No OEM Part # Available)

GRAY KNOB SET

- Includes all parts as shown
- 3/16" diameter "D" shaped shaft
- Fits:** Needle Valve for HPCB & Valve for Master Control Block

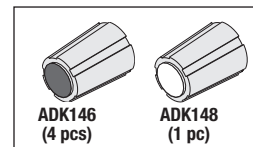

RPI Part #ADK145
OEM Part #027-017-00

BLACK BODY KNOB W/ BLUE DOT

- 4 per package; 3/16" diameter shaft "D" shaped shaft
- Fits:** Needle Valve for HPCB & Valve for Master Control Block



RPI Part #ADK146
OEM Part #027-017-01

GRAY BODY KNOB W/ BLUE DOT

- 4 per package; 3/16" diameter "D" shaped shaft
- Fits:** Needle Valve for HPCB & Valve for Master Control Block



RPI Part #ADK147
OEM Part #027-018-00

BLACK BODY KNOB W/ YELLOW DOT

- 4 per package; 3/16" dia. "D" shaped shaft
- Fits:** Needle Valve for HPCB & Valve for Master Control Block



RPI Part #ADK148
OEM Part #027-018-01

GRAY BODY KNOB W/ YELLOW DOT

- 4 per package; 3/16" dia. "D" shaped shaft
- Fits:** Needle Valve for HPCB & Valve for Master Control Block



Handpiece Control Block Century Water Valve Assembly (OEM Part #38.0098.00)

RPI Part #ADK071
OEM Part # (No OEM Part # Available)

WATER VALVE SERVICE KIT

- Includes all parts as shown
- Model:** Handpiece Control Block Century Water Valve Assembly (OEM Part #38.0098.00)

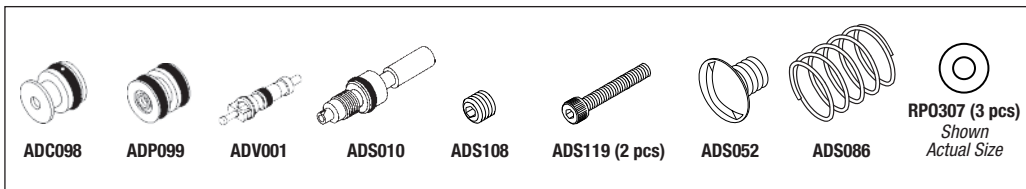

Control Head Components

RPI Part #ADS075
OEM Part #40-0250-00

AIR ACTUATED ELECTRIC SWITCH

- Normally open; 5A
- Includes: (2 pcs) Wire Nut (RPI Part #RPT017), 1/16" tubing barb (#10-32 port) and panel mount hardware

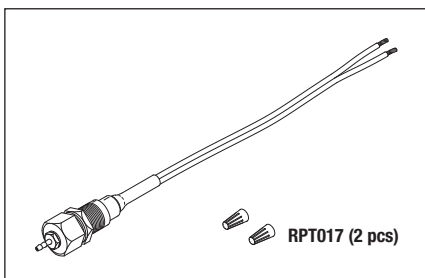

RPI Part #PCG760
OEM Part #026.083.01

PRESSURE GAUGE

- 1-3/4" w x 1/2" h x 2-1/4" lg.
- 0-60 PSI; 0-4 Bar
- Port: #10-32 threaded inlet
- Includes all parts as shown

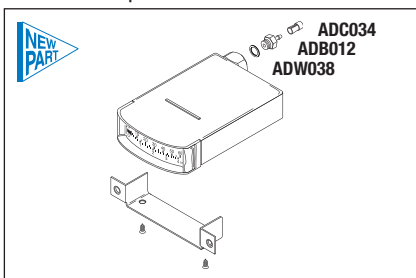

RPI Part #PCL768
OEM Part #24.0100.03

AIR INDICATOR (GREEN)

- Nickel plated brass
- Black bezel
- Port: #10-32 threaded inlet with 1/16" barb
- Mounts in 1/2" dia. hole
- Includes all parts as shown

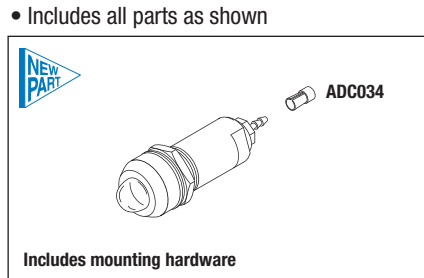

RPI Part #PCV766
OEM Part # (No OEM Part # Available)



VALVE TOGGLE SWITCH

- Replacement for Purge **or** On/Off Toggle Valve
- Swivels for easy connection to tubing
- Material: Nickel plated brass
- Port: #10-32 threaded inlet with 1/16" barb
- Mounts in 1/2" dia. hole
- Includes all parts as shown

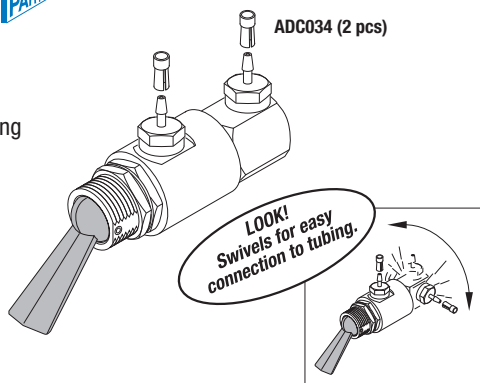

ADC034 (2 pcs)
ADB012 (2 pcs)
ADW038 (2 pcs)



RPI Part #PCV767
OEM Part #026.073.02

CHECK VALVE

- Material: Brass body
- Port: #10-32 threaded inlet with 1/16" barb
- Allows water or air to flow in one direction only
- Includes all parts as shown

RPI Part #ADV179
OEM Part #33-0008-00

CUP FILL TOGGLE VALVE (BLACK)

- Includes all parts as shown
 - 2-way momentary valve
- Fits:** Dental systems prior to 1982 with cup fill towers

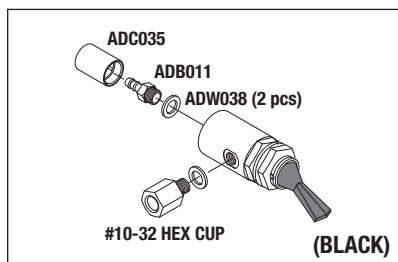

RPI Part #ADP049
OEM Part #011-024-00

STRAIGHT PIN

- 10 per package
 - Material: Stainless steel
 - Size: .062 dia. x .460 Lg.
- Fits:** Push Button Valve & 2-Way Toggle Valves

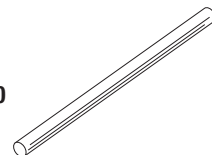

RPI Part #ADV180
OEM Part # (No OEM Part # Available)

CUP FILL TOGGLE VALVE (GRAY)

- Includes all parts as shown
 - 2-way momentary valve
- Fits:** Dental systems prior to 1982 with cup fill towers

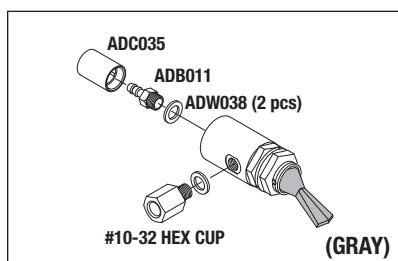

RPI Part #ADP050
OEM Part #011-038-00

STRAIGHT PIN

- 10 per package
 - Material: Stainless steel
 - Size: .062 dia. x .430 Lg.
- Fits:** Micro-Selector Valve, 2-Way Routing Selector Valve, 2-Way and 3-Way Toggle Valve & Autoclavable and Continental Syringes

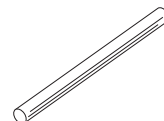

RPI Part #ADV181
OEM Part #33-0034-01

2 WAY MOMENTARY TOGGLE VALVE (BLACK)

- Includes all parts as shown
 - 2-way momentary valve
- Fits:** Dental systems with water purge and air brake systems

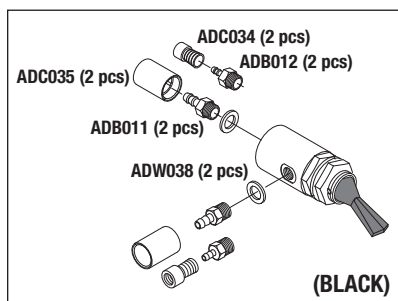

RPI Part #ADP051
OEM Part #011-039-00

STRAIGHT PIN

- 10 per package
 - Material: Stainless steel
 - Size: .062 dia. x .450 Lg.
- Fits:** Valve Assemblies & Toggle 3-Way Cartridge

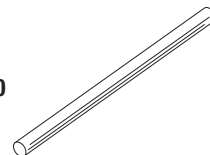

RPI Part #ADV182
OEM Part # (No OEM Part # Available)

2 WAY MOMENTARY TOGGLE VALVE (GRAY)

- Includes all parts as shown
 - 2-way momentary valve
- Fits:** Dental systems with water purge and air brake systems

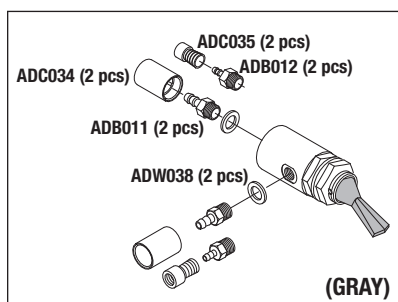

RPI Part #ADV244
OEM Part #33.0138.00 & 29.1085.00



MICRO VALVE

- Material: Nickel plated brass
 - 1/16" Barbs (use with 1/16" ID x 1/8" OD Tubing)
 - 3-Way Normally Closed
- Models:** Foot Control Accessory Button (OEM Part #38.0612.00) & Wet/Dry Toggle Valve (OEM Part #38.0604.00)

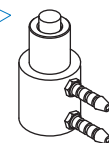

Dental Equipment

Utility Module (OEM Part #24-0352-00)

UTILITY MODULE (OEM Part #24-0352-00)

Exploded View
(Kit parts identified in bold text -
All parts also sold separately)

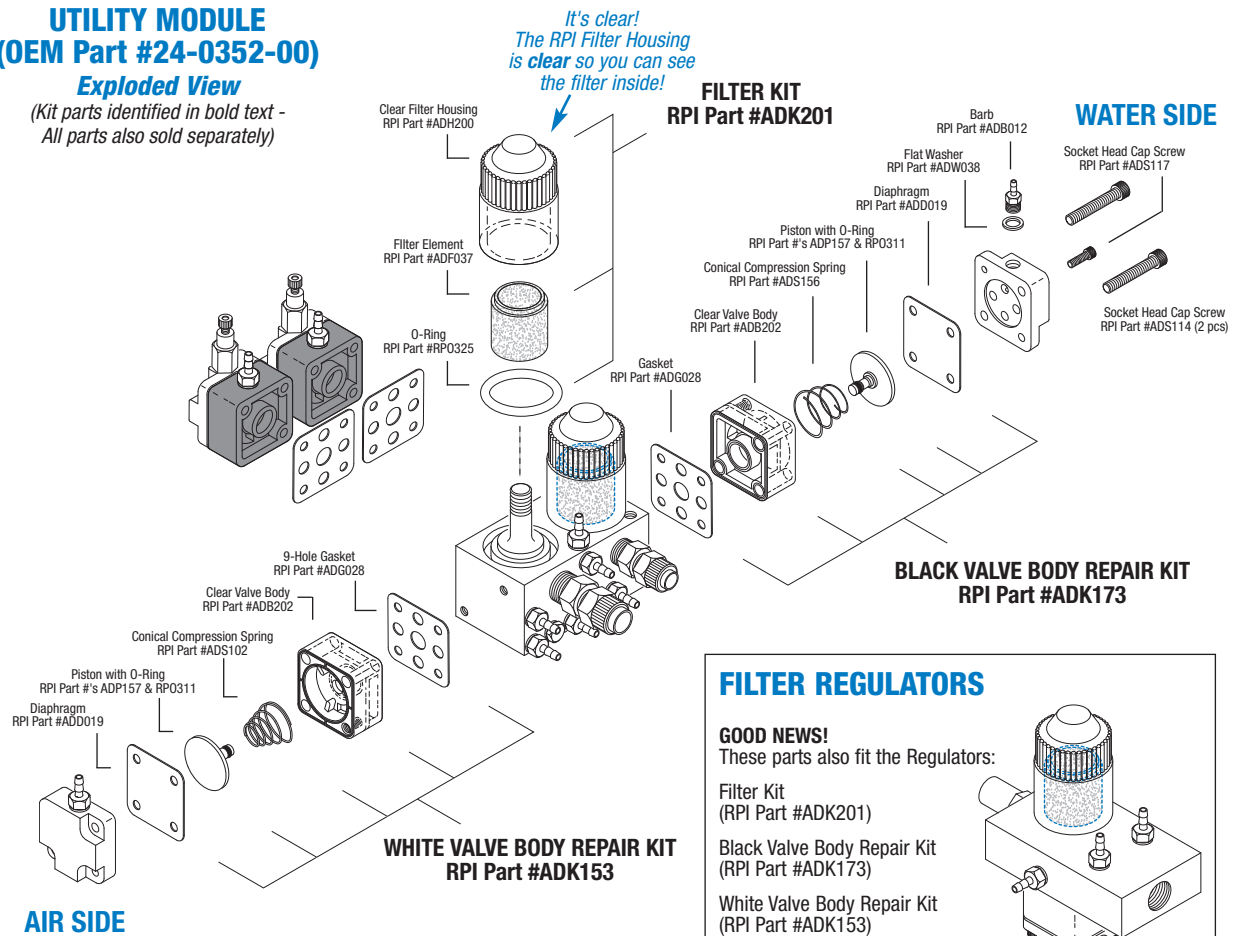

FILTER REGULATORS

GOOD NEWS!
These parts also fit the Regulators:

- Filter Kit (RPI Part #ADK201)
- Black Valve Body Repair Kit (RPI Part #ADK173)
- White Valve Body Repair Kit (RPI Part #ADK153)

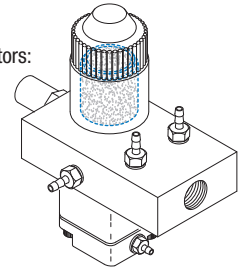

RPI Part #ADK153
OEM Part #24-0135-00



WHITE VALVE BODY REPAIR KIT

- This kit has been upgraded to include the Clear Valve Body (RPI Part #ADB202)
- Includes all parts as shown

Fits: Air Regulator Valve "White" Bodies (OEM Part #24-0135-00)

RPI Part #ADK173
OEM Part #24-0355-00



BLACK VALVE BODY REPAIR KIT

- This kit has been upgraded to include the Clear Valve Body (RPI Part #ADB202)
- Includes all parts as shown

Fits: Water Regulator Valve "Black" Bodies (OEM Part #24-0355-00)

RPI Part #ADK201
OEM Part #24-0229-00/
24-0234-00/030-019-00



FILTER KIT

- New round design for enhanced performance
- The RPI Filter Housing is clear so you can see when the filter needs replacement without having to remove the housing
- Includes all parts as shown

Models: See top of page 510 for Models this part fits.

CLEAR VALVE BODY!

RPI's valve body is clear for easy troubleshooting!

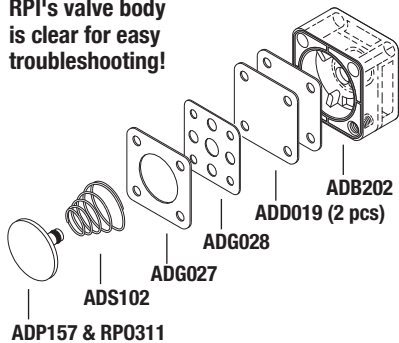

All parts in Kit also sold separately

CLEAR VALVE BODY!

RPI's valve body is clear for easy troubleshooting!

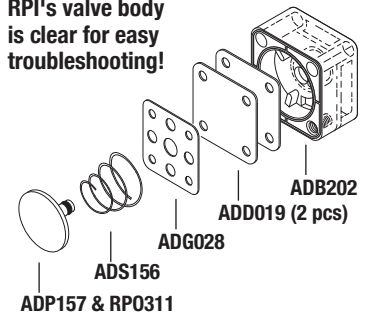

All parts in Kit also sold separately

CLEAR HOUSING!

The RPI filter housing is clear so you can see when the filter needs replacement without having to remove the housing. It's the RPI Advantage.

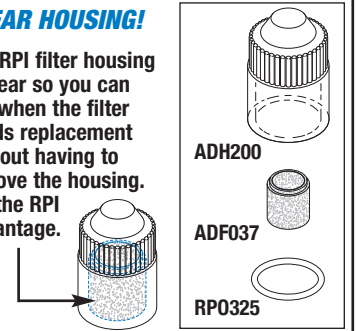

RPI Part #ADK201
OEM Part #'s
24-0229-00 (A-dec Filter Housing)/
24-0234-00 (A-dec Filter Element-1/pkg)/
030-019-00 (A-dec O-ring)
62R052 (Pelton & Crane and Marus Filter Housing)/
62R050 (Pelton & Crane and Marus Filter Element)/
007R019 (Pelton & Crane and Marus O-Ring)

FILTER KIT

- New round design for enhanced performance
- The RPI Filter Housing is clear so you can see when the filter needs replacement without having to remove the housing
- Includes all parts as shown

Models: See Chart below.

THE RPI ADVANTAGE!

The RPI filter housing is clear so you can see when the filter needs replacement without having to remove the housing.

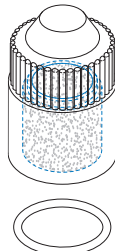

RPI Part #ADH200
OEM Part #24-0229-00 (A-dec Filter Housing)/
62R052 (Pelton & Crane and Marus Filter Housing)

FILTER HOUSING

- The RPI Filter Housing is clear so you can see when the filter needs replacement without having to remove the housing

Models: See Chart to the left.

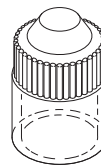

CLEAR HOUSING!

RPI Part #ADF037
OEM Part #24-0234-01 (A-dec Filter Element-6/pkg)/
62R050 (Pelton & Crane and Marus Filter Element)

FILTER ELEMENT

- 6 per package
- Plastic (white)
- 60-100 micron filtration for air or water

Models: See Chart to the left.



RPI Part #RPO325

OEM Part #
030-019-00 (A-dec O-ring)/
007R019 (Pelton & Crane and Marus O-Ring)
Industry Part #AS568-019

O-RING

- 12 per package
- Buna-N (Nitrile), 70 Duro
- .801" ID x .941" OD x .070" C/S

Models: See Chart to the left.

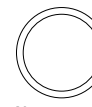

Not to scale.

THE RPI FILTER KIT (RPI PART #ADK201) FITS THE FOLLOWING DENTAL DELIVERY SYSTEM COMPONENTS

A-dec	Filter Regulator	24-0168-00
	Filter Regulator	24-0170-00
	Filter Regulator	24-0175-00
	Utility Module	24-0352-00
Chapman-Hoffman	J-Box Shut-Off Valve Assy	19-075-00 & 19-081-00
DCI	Filter Regulator	7212
	Filter for Air or Water	7246
Marus	Master Air Shut-Off Valve	55R346
	Master Water Shut-Off Valve	55R347
Pelton & Crane	Master Air Shut-Off Valve	55R346
	Master Water Shut-Off Valve	55R347

RPI Part #ADF036
OEM Part #19-0220-01/
19-0220-00

FILTER

- 5 per package
- Material: Sintered bronze
- Size: .625" OD x .062" Thk
- Also included in: Water Filter Service Kit (RPI Part #ADK072)

- Service Tip: Replace O-Ring (RPI Part #RPO317) when replacing filter

Models: Water Filter Regulator (OEM Part #40-0654-00) & In Line Filter Assembly (OEM Part #19-0100-00)

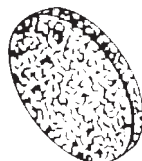

RPI Part #ADF037
OEM Part #24-0234-01
(A-dec Filter Element-6/pkg)/
62R050 (Pelton & Crane
and Marus Filter Element)

FILTER ELEMENT

- 6 per package
- Material: Plastic (white)
- 60-100 micron filtration for air or water
- Service Tip: Replace O-Ring (RPI Part #RPO325) when replacing filter element
- Also included in: Filter Kit (RPI Part #ADK201)

Models: See Chart above for RPI Part #ADK201

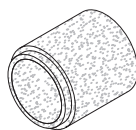

RPI Part #ADF069
OEM Part #97-0280-00/
97-0280-02

FILTER ELEMENT

- Material: Plastic (white)
 - 40 micron filtration
 - Service Tip: Replace O-Ring (RPI Part #RPO322) when replacing filter element
- Models: Air Filter Regulator (OEM Part #026-021-01) & Filter/Moisture Separator (OEM Part #026-066-00)**

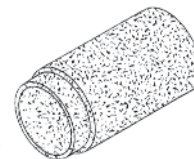

RPI Part #RPO322
OEM Part #030-023-02
Industry Part #2-023

O-RING

- 12 per package
 - Buna-N (Nitrile)
 - Hardness: 70 Duro
 - Size: 1.051" ID x 1.191" OD x .070" C/S
- Models: Air Filter Regulator (OEM Part #026-021-01) & Filter/Moisture Separator (OEM Part #026-066-00)**

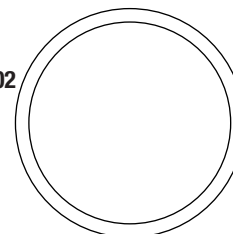

RPI Part #RPO317
OEM Part #030-016-00
Industry Part #AS568-016

O-RING

- 12 per package
 - Material: Buna-N (Nitrile), 70 Duro
 - Size: .614" ID x .754" OD x .070" C/S
- Models: Water Filter Regulator (OEM Part #40-0654-00), In Line Filter Assembly (OEM Part #19-0100-00)**

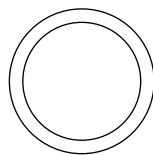

RPI Part #RPO325
OEM Part #030-019-00
(A-dec O-ring)/007R019
(Pelton & Crane and
Marus O-Ring)
Industry Part #AS568-019

O-RING

- 12 per package
 - Material: Buna-N (Nitrile), 70 Duro
 - Size: .801" ID x .941" OD x .070" C/S
 - Also included in: Filter Kit (RPI Part #ADK201)
- Models: See Chart above for RPI Part #ADK201**

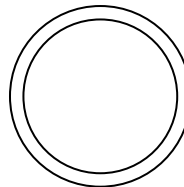

O-Ring illustrations are actual size

Dental Equipment

Water Coolant Relay Assembly 500 Series (OEM Part #38.1810.00), Coolant Air Valve (OEM Part #22-0940-00) and Coolant Water Valve (OEM Part #'s 22-0960-00 & 22-0790-00)

500 Series WATER COOLANT RELAY ASSEMBLY (OEM Part #38.1810.00)

Exploded View

(Kit parts identified in bold text - All parts also sold separately)

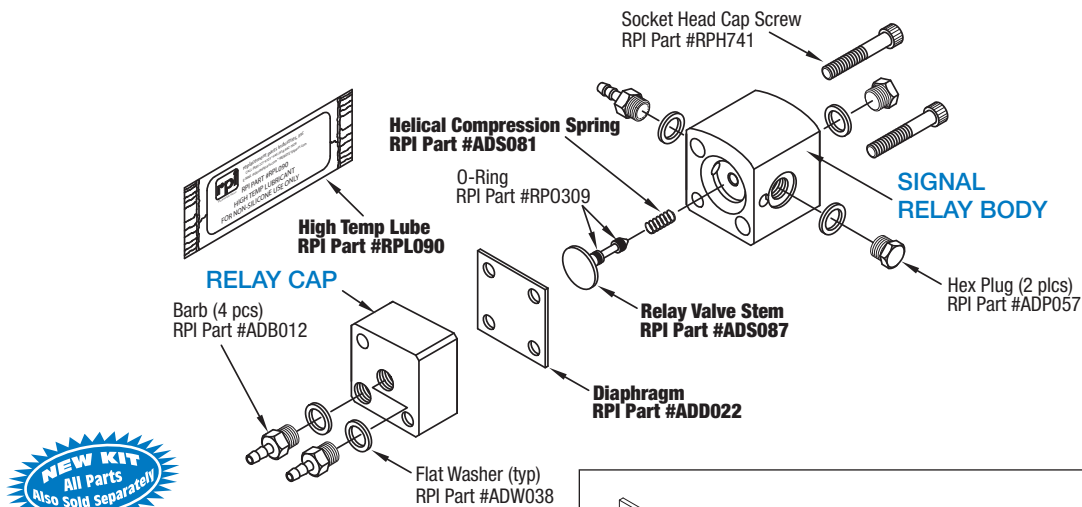

RPI Part #ADK252
OEM Part #38.1810.00 (Relay Assy)

WATER COOLANT RELAY KIT

- Includes all parts as shown
- Fits:** Water Coolant Relay Assembly 500 Series (OEM Part #38.1810.00)

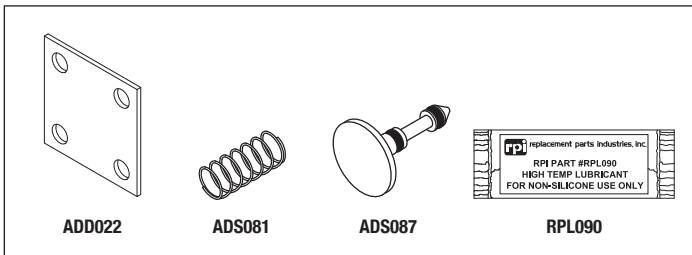

RPI Part #ADK095
OEM Part #90-0012-00

AIR COOLANT VALVE SERVICE KIT

- Includes all parts as shown
- Fits:** Coolant Air Valve (OEM Part #22-0940-00)

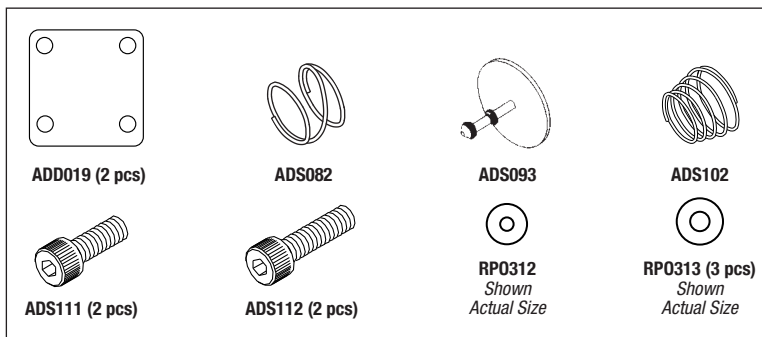

RPI Part #ADK096
OEM Part #90-0014-00

WATER COOLANT VALVE SERVICE KIT

- Includes all parts as shown
- Fits:** Coolant Water Valve (OEM Part #'s 22-0960-00 & 22-0790-00)

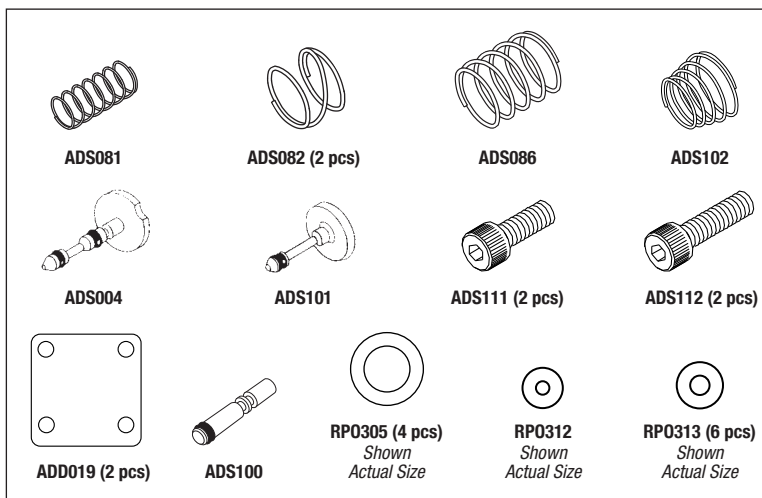

RPI Part #ADK072
OEM Part #90-0070-00

WATER FILTER SERVICE KIT

- Includes all parts as shown

Model: Water Filter-Regulator (OEM Part #40-0654-00)



RPI Part #ADK074
OEM Part #90-0030-00

AIR FILTER REGULATOR SERVICE KIT

- Includes all parts as shown

Model: Air Filter Regulator (OEM Part #026-021-01)

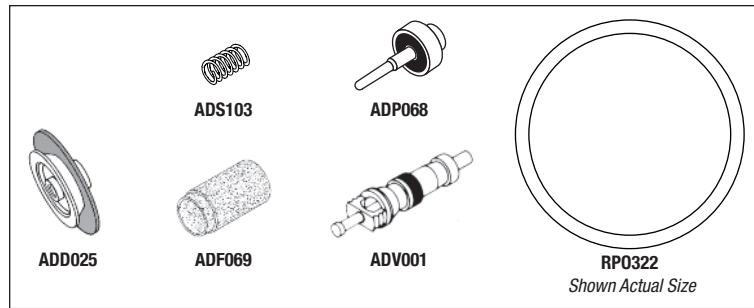

RPI Part #ADK131
OEM Part #90-0040-00

AIR & WATER REGULATOR SERVICE KIT

- Includes all parts as shown

Model: Air and Water Filter Regulator (OEM Part #40-0654-00)

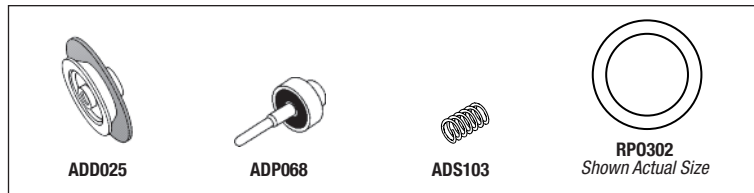

RPI Part #ADK076
OEM Part #90-0090-00

SHUT-OFF VALVE SERVICE KIT (AIR & WATER)

- Includes all parts as shown

Model: Air and Water Shut-Off Valve (Air-Operated) (OEM Part #30-0330-00)

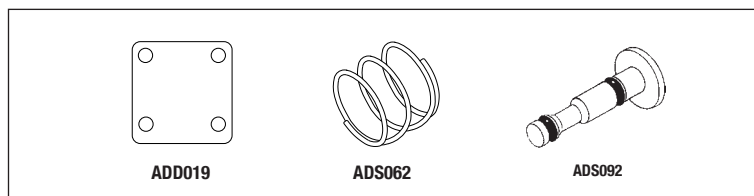

NOTES:

Dental Equipment

Foot Control 300 Series (OEM Part #38.1821.00), 500 Series (OEM Part #38.1805.00), Foot Control (OEM Part #38-0050-00), Foot Control II (OEM Part #38-0254-00), Foot Control III (OEM Part #'s 38.1601.00, 38.1603.00, & 38.1700.00) & Foot Control Lever Action (OEM Part #38-0200-00)



FOOT CONTROL III SERVICE KIT

RPI Part #ADK245

(Kit parts identified in bold text - All parts also sold separately)

With this Service Kit, you can rebuild the air and water controls or rebuild both!

FOR DETAILS ABOUT THIS KIT, SEE PAGE 514

FOOT CONTROL (OEM Part #'s 300 Series (38.1821.00), 500 Series (38.1805.00), Foot Control (38-0050-00), Foot Control III (38.1601.00, 38.1603.00 & 38.1700.00) Exploded View

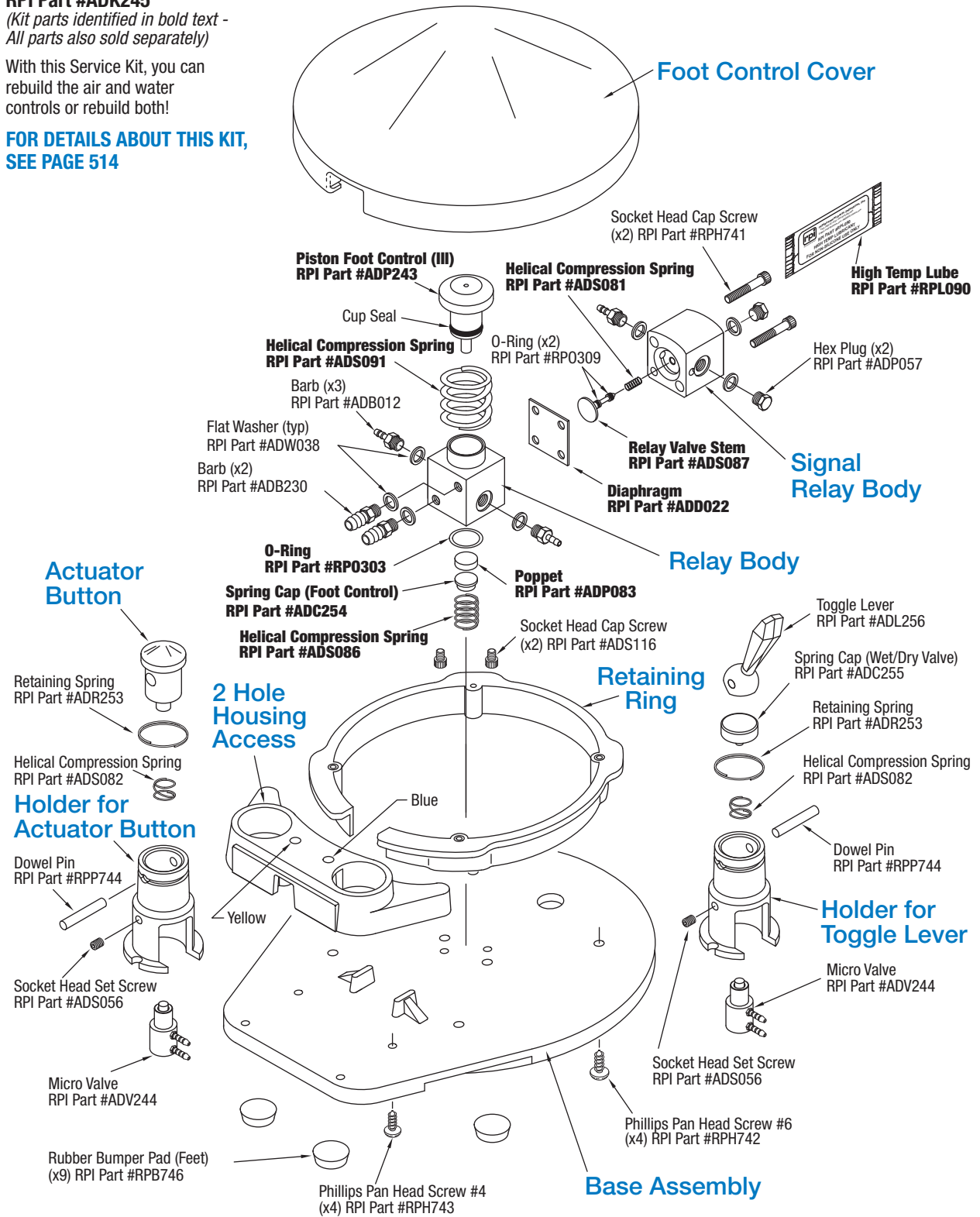

Foot Control 300 Series (OEM Part #38.1821.00), 500 Series (OEM Part #38.1805.00), Foot Control (OEM Part #38-0050-00), Foot Control II (OEM Part #38-0254-00), Foot Control III (OEM Part #'s 38.1601.00, 38.1603.00, & 38.1700.00) & Foot Control Lever Action (OEM Part #38-0200-00) (continued)



RPI Part #ADK245
OEM Part #90.0593.00

FOOT CONTROL III SERVICE KIT

- Includes all parts as shown

Models:

Foot Control 300 Series (OEM Part #38.1821.00),
Foot Control 500 Series (OEM Part #38.1805.00), &
Foot Control III (OEM Part #'s 38.1601.00,
38.1603.00 & 38.1700.00)

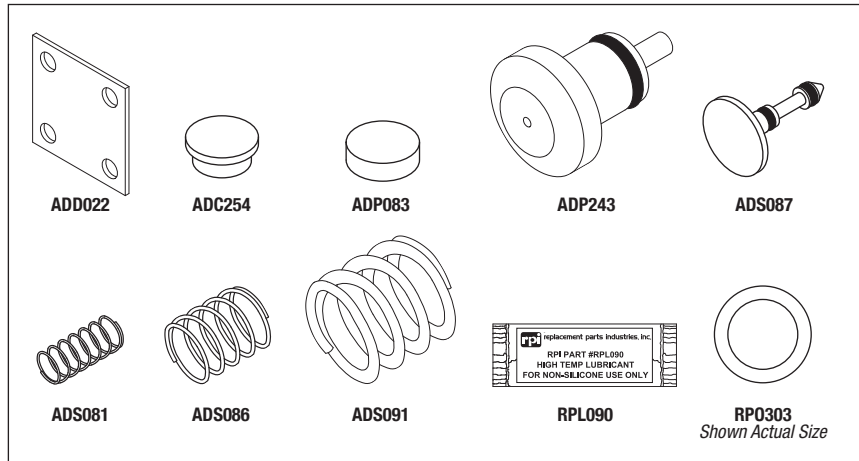

RPI Part #ADK089
OEM Part #90-0312-00

FOOT CONTROL II SERVICE KIT

- Includes all parts as shown

Model: Foot Control II (OEM Part #38-0254-00)

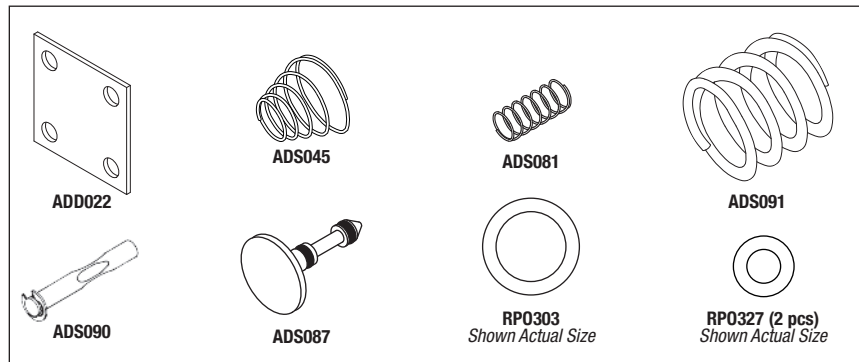

RPI Part #ADK088
OEM Part #90-0010-00

FOOT CONTROL SERVICE KIT

- Includes all parts as shown

Model: Foot Control (OEM Part #38-0050-00)

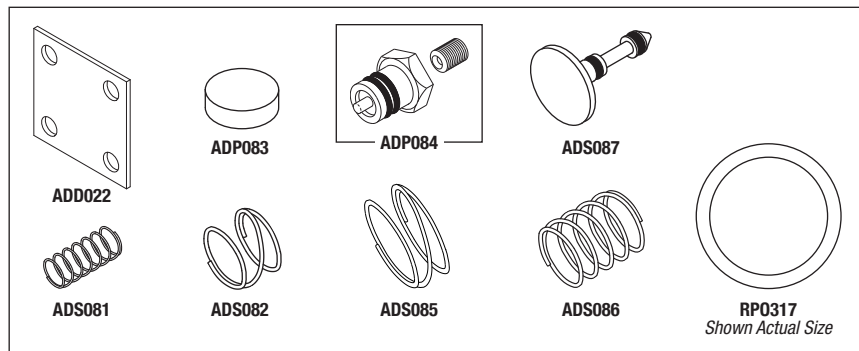

RPI Part #ADK122
OEM Part #90-0313-00

FOOT CONTROL SERVICE KIT (LEVER)

- Includes all parts as shown

Model: Foot Control Lever Action (OEM Part #38-0200-00)

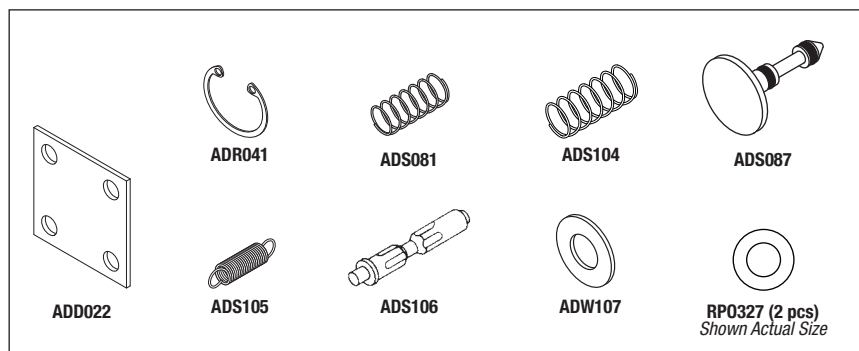

RPI Part #ADK080

OEM Part # (No OEM Part # Available)

BARB KIT

- Kit includes 12-Compartment Storage Case (RPI Part #RPB415)
- All parts also sold separately in quantities indicated below

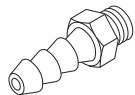
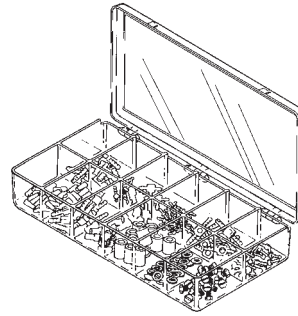

ADB011

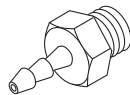

ADB012

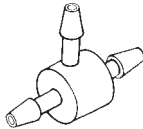

ADB013



ADB014

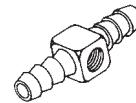

ADB015

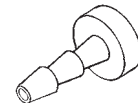

ADB016

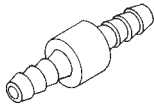

ADB018

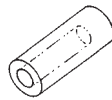

ADC017

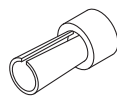

ADC034

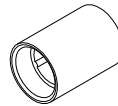

ADC035



ADP057



ADW038

RPI PART #	OEM PART#	DESCRIPTION	MATERIAL	FITS	KIT QTY	REORDER QTY (PER PKG)
ADB011	023-001-01	1/8" BARB TO #10-32 MALE THREAD	BRASS	1/8" ID TUBING	20	10
ADB012	023.004.03*	1/16" BARB TO #10-32 MALE THREAD	BRASS	1/16" ID TUBING	20	10
ADB013	023-014-01	1/16" BARB TEE	NYLON®	1/16" ID TUBING	20	10
ADB014	023-019-03**	1/16" INLINE BARB	BRASS	1/16" ID TUBING	20	10
ADB015	023-022-00	1/8" BARB TEE-BODY WITH #10-32 FEMALE THREAD	BRASS	1/8" ID TUBING	10	5
ADB016	023-030-00	1/16" BARB TUBING PLUG	BRASS	1/16" ID TUBING	20	10
ADB018	023-045-01	1/8" INLINE BARB	BRASS	1/8" ID TUBING	10	5
ADC017	023-031-01	1/16" BARB CAP	PLASTIC	1/16" OD BARB	20	10
ADC034	025.007.01	UNI-CLAMP	PLASTIC	1/8" OD TUBING	40	20
ADC035	025-015-01	SLEEVE CLAMP	PLASTIC	1/4" OD TUBING	20	20
ADP057	021.016.00***	HEX PLUG WITH #10-32 MALE THREAD	BRASS	#10-32 FEMALE THREAD	20	10
ADW038	004-005-00	FLAT WASHER (.187" ID x .312" OD x .031" thk)	NYLON®	#10-32 MALE THREAD	100	50

* 1/16" BARB TO #10-32 MALE THREAD (RPI PART #ADB012) ALSO REFERS TO OEM PART#023-004-01.

** 1/16" INLINE BARB (RPI PART #ADB014) ALSO REFERS TO OEM PART#'s 023-019-01 & 023-019-02.

*** HEX PLUG WITH #10-32 MALE THREAD (RPI PART #ADP057) ALSO REFERS TO OEM PART#021-016-01.

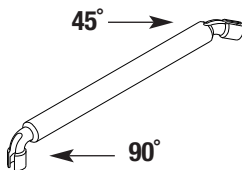

RPI Part #RPT294

OEM Part # (No OEM Part # Available)

1/8" SLEEVE TOOL

- Use on 1/8" OD tubing
- Use to install all 1/8" sleeve clamps and Uni-Clamp (RPI Part #ADC034)
- The tool provides 90° and 45° angles for ease of use
- ~5" lg.

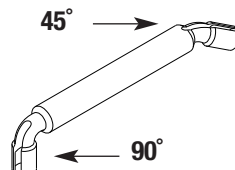

RPI Part #RPT295

OEM Part # (No OEM Part # Available)

1/4" SLEEVE TOOL

- Use on 1/4" OD tubing
- Use to install all 1/4" sleeve clamps and Uni-Clamp (RPI Part #ADC035)
- The tool provides 90° and 45° angles for ease of use
- ~5" lg.

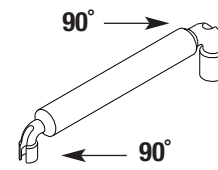

RPI Part #RPT296

OEM Part # (No OEM Part # Available)

UNIVERSAL SLEEVE TOOL

- Use on 1/8" OD tubing and 1/4" OD tubing
- Use to install all 1/8" and 1/4" sleeve clamps and Uni-Clamps (RPI Part #'s ADC034 & ADC035)
- The tool provides 90° angles on both ends for ease of use
- ~5" lg.

Dental Equipment

Barbs, Clamps, Sleeves & Washers (continued)



THE RPI ADVANTAGE!

All parts are also included in the Control Block Kit (Major) - RPI Part #ADK241 See page 502

With the Kit, you can easily replace any of the Control Block parts, or completely rebuild the Control Block. Save money and time with the Kit!

RPI Part #ADB230
OEM Part #023.505.01

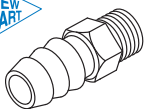

BARB

- 10 per package
- Material: Brass
- Size: 3/16" barb to #10-32 male thread
- Use with 3/16" ID x 5/16" OD tubing
- Also available: Washer (RPI Part #ADW038)
- Also included in: Control Block Kit (Major) (RPI Part #ADK241)

Models: Handpiece Control Bock 300 Series (OEM Part #38.1831.00) & 500 Series (OEM Part #38.1776.00)

RPI Part #ADB231
OEM Part #023.811.00

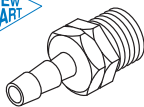

BARB (RESTRICTOR)

- 10 per package
- Material: Brass
- Size: 1/16" barb to #10-32 male thread
- .018" Orifice
- Use with 1/16" ID x 1/8" OD tubing
- Also available: Washer (RPI Part #ADW038)
- Also included in: Control Block Kit (Major) (RPI Part #ADK241)

Models: Handpiece Control Bock 300 Series (OEM Part #38.1831.00) & 500 Series (OEM Part #38.1776.00)

RPI Part #ADW038
OEM Part #004-005-00



FLAT WASHER

- 50 per package
- Material: Nylon®
- Size: .187" ID x .312" OD x .031" thk
- Fits: #10-32 male thread port

RPI Part #ADW039
OEM Part #004-036-00



FLAT WASHER

- 15 per package
- Material: Nylon®
- Size: .140" ID x .320" OD x .06" thk
- Fits: #6-32 male thread port

RPI Part #ADB249
OEM Part #026.175.01

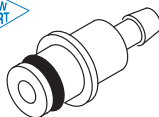

QUICK DISCONNECT BARB

- 5 per package
- Material: Brass
- Use with 1/8" ID x 3/16" OD silicone hand-piece tubing only
- Includes: O-Ring (RPI Part #RPO307)
- Also included in: Control Block Kit (Major) (RPI Part #ADK241)

Models: Handpiece Control Bock 300 Series (OEM Part #38.1831.00) & 500 Series (OEM Part #38.1776.00)

RPI Part #ADB250
OEM Part #026.161.00

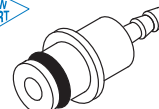

QUICK DISCONNECT BARB

- 5 per package
- Material: Brass
- Use with 1/16" ID x 1/8" OD vinyl hand-piece tubing only
- Includes: O-Ring (RPI Part #RPO307)
- Also included in: Control Block Kit (Major) (RPI Part #ADK241)

Models: Handpiece Control Bock 300 Series (OEM Part #38.1831.00) & 500 Series (OEM Part #38.1776.00)

RPI Part #ADB248
OEM Part #026.174.01

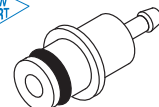

QUICK DISCONNECT BARB

- 5 per package
- Material: Brass
- Use with 1/16" ID X 1/8" OD silicone handpiece tubing only
- Includes: O-Ring (RPI Part #RPO307)
- Also included in: Control Block Kit (Major) (RPI Part #ADK241)

Models: Handpiece Control Bock 300 Series (OEM Part 38.1831.00) & 500 Series (OEM Part 38.1776.00)

RPI Part #ADW107
OEM Part #004-057-00



FLAT WASHER

- 6 per package
- Material: Brass
- Size: .185" ID x .371" OD

RPI Part #ADW186
OEM Part #004-078-00



FLAT WASHER

- 5 per package
- Material: Plastic
- Size: .090" ID x .190" OD x .020" thk

RPI Part #ADB251
OEM Part #026.088.00

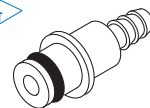

QUICK DISCONNECT BARB

- 5 per package
- Material: Brass
- Use with 1/8" ID x 1/4" OD vinyl handpiece tubing only
- Includes: O-Ring (RPI Part #RPO307)
- Also included in: Control Block Kit (Major) (RPI Part #ADK241)

Models: Handpiece Control Bock 300 Series (OEM Part 38.1831.00) & 500 Series (OEM Part 38.1776.00)

RPI Part #ADP232
OEM Part #026.160.01

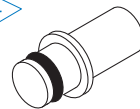

QUICK DISCONNECT PLUG

- 5 per package
- Material: Brass
- Includes: O-Ring (RPI Part #RPO307)
- Included in Control Block Kit (Major) (RPI Part #ADK241)

Models: Handpiece Control Bock 300 Series (OEM Part 38.1831.00) & 500 Series (OEM Part 38.1776.00)

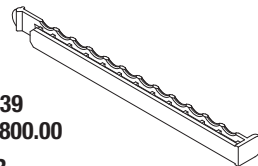

RPI Part #ADR239
OEM Part #38.1800.00

BARB RETAINER

- Included in Control Block Kit (Major) (RPI Part #ADK241) & Control Block Kit (Minor) (RPI Part #ADK257)

Models: Handpiece Control Bock 500 Series (OEM Part 38.1776.00)

RPI Part #ADC065
OEM Part #025-021-00

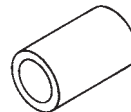

SLEEVE CLAMP

- 5 per package
- Material: Chrome plated brass
- Size: 9/64" ID

RPI Part #ADC063
OEM Part #021-034-00

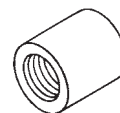

COUPLING

- 4 per package
- Material: Brass
- #10-32 Female

RPI Part ADS032
OEM Part #022-005-00



SLEEVE/FERRULE

- 25 per package
- Material: 1/4" Poly-Flo white plastic
- For 1/4" OD tubing

RPI Part #ADD020
OEM Part #22-0774-00

DIAPHRAGM

- 6 per package
 - Material: Fairprene
 - Size: .593" x .875"
- Fits:** Handpiece Control Valve

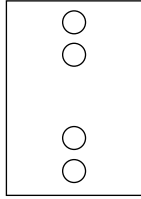

RPI Part #ADG124
OEM Part #29-0220-00

AUTO BLOCK GASKET (RED)

- 3 per package
 - Material: Polyester
 - Size: 1.015" x 1.015"
 - For lubricated drive air only
- Fits:** Handpiece Control Block Auto Block & Auto Pac

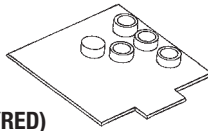

RPI Part #ADD023
OEM Part #38-0120-00

DIAPHRAGM

- 6 per package
 - Material: Fairprene
 - Size: 1.231" x 2.376"
- Fits:** Handpiece Control Block Century Pac

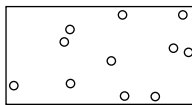

RPI Part #ADG029
OEM Part #35-0574-00

GASKET (MANIFOLD TUBING CONNECTOR)

- 3 per package
 - Material: Polyester
 - Size: .780" x 1.325"
- Fits:** Multi-Ported Tubing Manifold



RPI Part #ADD025
OEM Part #97-0200-00

DIAPHRAGM

- Material: Brass and neoprene
- Fits:** Air and Water Filter Regulator (OEM Part #40-0654-00)

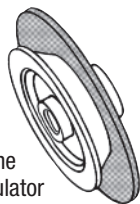

RPI Part #ADG158
OEM Part #38-0550-00

RED GASKET

- 5 per package
 - Size: .983" x 1.623"
 - Use only with the scaler block option - use Clear Gasket (RPI Part #ADG159) in all other positions
- Model:** Handpiece Control Block Century Plus (OEM Part #38.0540.00)

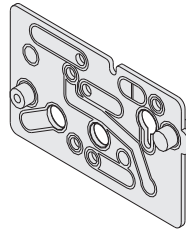

RPI Part #ADG159
OEM Part #38-0507-00

CLEAR GASKET

- 10 per package
 - Size: .983" x 1.623"
 - Use in all positions - use Red Gasket (RPI Part #ADG158) for scaler option
- Model:** Handpiece Control Block Century Plus (OEM Part #38.0540.00)

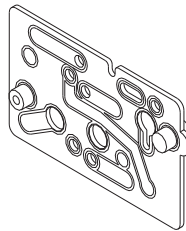

RPI Part #ADD160
OEM Part #38-0519-01

DIAPHRAGM

- 10 per package
 - Material: Fairprene
 - Size: ~.745" x 1.659"
- Model:** Handpiece Control Block Century Plus (OEM Part #38.0540.00)

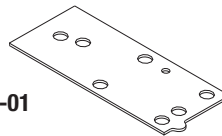

RPI Part #ADD238
OEM Part #38.1787.01

DIAPHRAGM

- 5 per package
 - Material: Fairprene
 - Size: 2.040" x 4.650"
- Model:** Handpiece Control Block 500 Series (OEM Part #38.1776.00)

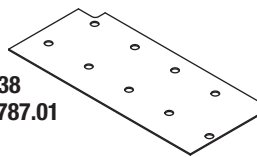

RPI Part #ADD024
OEM Part #38-0179-00

DIAPHRAGM

- 6 per package
 - Material: Fairprene
 - Size: .765" x 1.031"
- Model:** Handpiece Control Block Century II (OEM Part #38.0223.00)

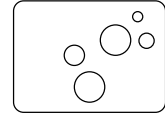

RPI Part #ADG031
OEM Part #38-0186-00

GASKET

- 6 per package
 - Material: Polyester
 - Size: .980" x 1.210"
- Model:** Handpiece Control Block Century II (OEM Part #38.0223.00)

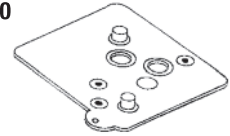

RPI Part #ADD022
OEM Part #38-0054-00

DIAPHRAGM

- 6 per package
 - Material: Fairprene
 - Size: .750" x .750"
- Models:** Handpiece Control Block Century II (OEM Part #38.0223.00); Foot Control 300 Series (OEM Part #38.1821.00), Foot Control 500 Series (OEM Part #38.1805.00), Foot Control (OEM Part #38-0050-00), Foot Control II (OEM Part #38-0254-00), Foot Control III (OEM Part #38.1601.00, 38.1603.00 & 381700.00), Foot Control Lever Action (OEM Part #38-0200-00); Water Coolant Relay Assembly 500 Series (OEM Part #38.1810.00); and Tooth Dryer Manifold

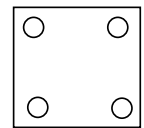

RPI Part #ADG027
OEM Part #24-0136-00

5 HOLE GASKET

- 6 per package
 - Material: Fairprene
 - Size: 1.000" x 1.000"
- Models:** Air Regulator Valve "White" Bodies (OEM Part #24-0135-00)

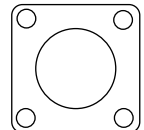

RPI Part #ADG028
OEM Part #24-0137-00

9 HOLE GASKET

- 6 per package
 - Material: Fairprene
 - Size: 1.030" x 1.030"
- Models:** Air Regulator Valve "White" Bodies (OEM Part #24-0135-00) & Water Regulator Valve "Black" Bodies (OEM Part #24-0355-00)

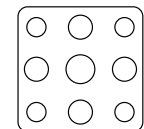

RPI Part #ADD019
OEM Part #22-0440-00

DIAPHRAGM

- 6 per package
 - Material: Fairprene
 - Size: 1.000" x 1.000"
- Models:** Air Regulator Valve "White" Bodies (OEM Part #24-0135-00) & Water Regulator Valve "Black" Bodies (OEM Part #24-0355-00)

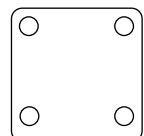

RPI Part #RPD114
OEM Part # (No OEM Part # Available)

GASKET/DIAPHRAGM SHEET MATERIAL

- Material: Fairprene
- Size: 12" x 12" x .015"
- Use for customizing gaskets and diaphragms

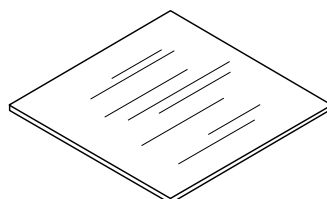

Dental Equipment

Cartridges, Pistons, Poppets & Stems

RPI Part #ADS123
OEM Part #29-0831-00

VALVE STEM (NEW STYLE)

- 2 per package
- **For non-retraction**
- Material: Plated brass
- Includes: (2 pcs) O-Ring (RPI Part #RPO309)

Model: Handpiece Control Block Century II (OEM Part #38.0223.00)

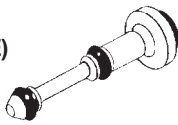

RPI Part #ADS005
OEM Part #29-0835-00

VALVE STEM

- 3 per package
- **For retraction**
- Material: Plated brass
- Includes: (1 pc) O-Ring (RPI Part #RPO309)

Model: Handpiece Control Block Century II (OEM Part #38.0223.00)

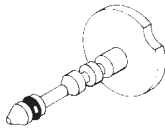

RPI Part #ADS007
OEM Part #33-0103-00

VALVE STEM NEEDLE

- Material: Plated brass
- Includes: (1 pc) O-Ring (RPI Part #RPO312)

Model: Handpiece Control Block Century II (OEM Part #38.0223.00)

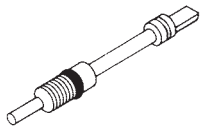

RPI Part #ADS077
OEM Part #33-0117-00

NEEDLE VALVE STEM

- Material: Plated brass
- Includes: (1 pc each) O-Ring (RPI Part #RPO307), and Retaining Ring (RPI Part #ADRO40)

Fits: Needle Cartridge Valve (Newer style)

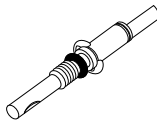

RPI Part #ADS055
OEM Part #29-0100-00

ADJUSTING SCREW

- 3 per package
- **For non-retraction with HPCB Century II**
- 10-32 x 5/8"
- Material: Plated brass
- Includes: (1 pc) O-Ring (RPI Part #RPO312)

Model: Handpiece Control Block Century II (OEM Part #38.0223.00), Century II Master Block, Auto-Block and Pac Control System

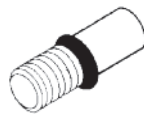

RPI Part #ADS168
OEM Part #38.0510.00

STEM (DRIVE AIR ADJ.)

- 3 per package
- Material: Nickel plated brass
- Includes: (1 pc) O-Ring (RPI Part #RP0752)

Model: Handpiece Control Block Century Plus (OEM Part #38.0540.00)

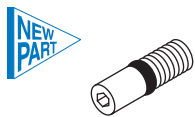

RPI Part #ADV161
OEM Part #38-0518-00

CARTRIDGE (CHECK VALVE)

- 3 per package
- Material: Brass cartridge (Blue top) and rubber duckbill with O-Ring

Model: Handpiece Control Block Century Plus (OEM Part #38.0540.00)



RPI Part #ADV163
OEM Part #38-0520-00

CARTRIDGE (WATER VALVE)

- 3 per package
- Material: Brass cartridge (Red top) and O-Rings

Model: Handpiece Control Block Century Plus (OEM Part #38.0540.00)



RPI Part #ADV162
OEM Part #38-0517-00

CARTRIDGE (AIR BLEED VALVE)

- 3 per package
- Material: Brass cartridge (Brass top) with O-Rings

Model: Handpiece Control Block Century Plus (OEM Part #38.0540.00)



RPI Part #ADP188
OEM Part #38.0646.00 & 38.0648.00 (Kit)

PLUG (CHECK VALVE)

- 3 per package
- Material: Brass cartridge (Black top); Replaces Cartridge (Check Valve) (RPI Part #ADV161)

Model: Handpiece Control Block Century Plus (OEM Part #38.0540.00)



RPI Part #ADP189
OEM Part #38.0647.00 & 38.0648.00 (Kit)

PLUG (WATER VALVE)

- 3 per package
- Material: Brass cartridge (Black top); Replaces Cartridge (Water Valve) (RPI Part #ADV163)

Model: Handpiece Control Block Century Plus (OEM Part #38.0540.00)

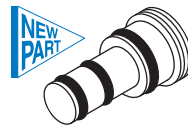

RPI Part #RPL090
OEM Part #98.0090.01

HIGH TEMP LUBRICANT

- 5 per package; 1/2 gram per unit
- **For Non-silicone use only. Do not use with highly oxidative chemicals (e.g. liquid chlorine, liquid oxygen, etc.).**
- Temperature range: -40°F to +400°F (-40°C to +204°C)

RPI Part #ADC236
OEM Part #38.1780.00

WATER CARTRIDGE ASSEMBLY

- For a wet block position
- Material: Brass
- Includes: Retaining Ring (RPI Part #ADR240), O-Ring (RPI Part #RPO312) & (3) O-Ring (RPI Part #RPO303)

Models: Handpiece Control Block 300 Series (OEM Part #38.1831.00) & 500 Series (OEM Part #38.1776.00)



RPI Part #ADC237
OEM Part #38.1783.00

WATER CARTRIDGE ASSY DRY

- For a dry block position
- Material: Brass
- Includes: Retaining Ring (RPI Part #ADR240) & (2) O-Ring (RPI Part #RPO303)

Models: Handpiece Control Block 300 Series (OEM Part #38.1831.00) & 500 Series (OEM Part #38.1776.00)

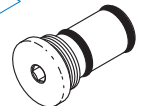

RPI Part #ADS235
OEM Part #38.1785.01

STEM (DRIVE AIR)

- Material: Nickel plated brass
- Includes: (1 pc) O-Ring (RPI Part #RP0752)

Models: Handpiece Control Block 300 Series (OEM Part #38.1831.00) & 500 Series (OEM Part #38.1776.00)

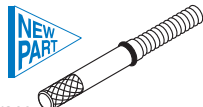

RPI Part #ADT242
OEM Part #38.1808.01/98.0867.02

STEM ADJUSTMENT TOOL

- 5 per package
- Material: Stainless steel
- Includes: (1 pc) O-Ring (RPI Part #RP0486)
- Can be used in place of either Handpiece Control Adjustment Keys (OEM Part #98.0867.02) or Flow Adjustment Keys (OEM Part #38.1808.01)

Model: Handpiece Control Block 500 Series (OEM Part #38.1776.00) and Century Plus (OEM Part #38.0540.00)



RPI Part #ADS233
OEM Part #38.0516.00

STEM (WATER FLOW ADJ.)

- Material: Nickel plated brass
- .125" hex socket
- Includes: O-Ring (RPI Part #RP0752)

Model: Handpiece Control Block 500 Series (OEM Part #38.1776.00) and Century Plus (OEM Part #38.0540.00)

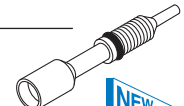

RPI Part #ADS234
OEM Part #38.0526.00

STEM (AIR COOLANT)

- Material: Nickel plated brass
- .125" hex socket
- Includes: O-Ring (RPI Part #RP0484)

Model: Handpiece Control Block 500 Series (OEM Part #38.1776.00)

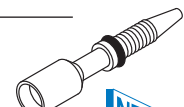

RPI Part #ADC098
OEM Part #38-0106-00

VALVE END CAP

- Material: Brass
- Includes: (1 pc) O-Ring (RPI Part #RPO305)

Model: Handpiece Control Block Cenutry Water Valve Assembly (OEM Part #38.0098.00)



RPI Part #ADP099
OEM Part #38-0104-00

PISTON

- Material: Brass
- Includes: (2 pcs) O-Rings (RPI Part #RPO305)

Model: Handpiece Control Block Cenutry Water Valve Assembly (OEM Part #38.0098.00)



RPI Part #ADS010
OEM Part #38-0102-00

VALVE STEM NEEDLE (BLACK)

- Material: Plastic
- Includes: (1 pc) O-Ring (RPI Part #RPO305)

Model: Handpiece Control Block Cenutry Water Valve Assembly (OEM Part #38.0098.00)

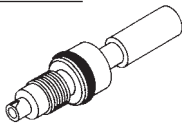

RPI Part #ADP068
OEM Part #97-0240-00

POPPET

- Material: Brass with rubber seat
- Models:** Air Filter Regulator (OEM Part #026-021-01) & Water Filter Regulator (OEM Part #40-0654-00)

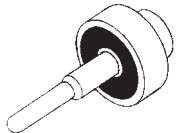

RPI Part #ADP157
OEM Part #24-0132-00

PISTON WITH O-RING

- 5 per package;
- Material: White plastic
- Includes: with (1 pc) O-Ring (RPI Part #RPO311)

Models: Air Regulator Valve "White" Bodies (OEM Part #24-0135-00) & Water Regulator Valve "Black" Bodies (OEM Part #24-0355-00)



RPI Part #ADS106
OEM Part #38-0211-00

VALVE STEM

- Material: Brass with plastic seat
- Models:** Foot Control Lever Action (OEM Part #38-0200-00)

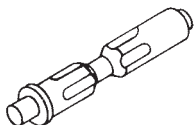

RPI Part #ADS087
OEM Part #22-0778-00

RELAY VALVE STEM

- 5 per package
- Material: Brass
- Includes: (2 pcs) O-Ring (RPI Part #RPO309)

Models: Foot Control (OEM Part #38-0050-00), Foot Control II (OEM Part #38-0254-00), Foot Control III (OEM Part #'s 38.1601.00, 38.1603.00 & 38.1700.00), Foot Control 300 Series (OEM Part #38.1821.00), Foot Control 500 Series (OEM Part #38.1805.00) Foot Control Lever Action (OEM Part #38-0200-00) & Water Coolant Relay Assembly 500 Series (OEM Part #38.1810.00)



RPI Part #ADS090
OEM Part #38-0246-00

FOOT CONTROL STEM

- Material: Brass
- Includes: (1 pc) Retaining Ring (RPI Part #ADRO40)

Model: Foot Control II (OEM Part #38-0254-00)

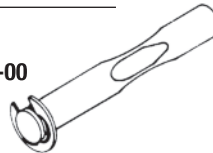

RPI Part #ADP243
OEM Part #38.0760.00



PISTON (FOOT CONTROL III)

- Material: Delrin
- Includes: (1 pc) Cup Seal (RPI Part #RPS748)
- Models:** Foot Control III (OEM Part #'s 38.1601.00, 38.1603.00, & 38.1700.00), Foot Control 300 Series (OEM Part #38.1821.00) & Foot Control 500 Series (OEM Part #38.1805.00)

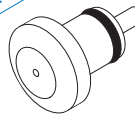

RPI Part #ADP083
OEM Part #22-0060-00

POPPET

- 10 per package
- Material: Plastic
- Models:** Foot Control III (OEM Part #'s 38.1601.00, 38.1603.00, & 38.1700.00), Foot Control (OEM Part #38-0050-00), Foot Control 300 Series (OEM Part #38.1821.00) & Foot Control 500 Series (OEM Part #38.1805.00)



RPI Part #ADC255
OEM Part #38.0066.00



SPRING CAP (WET/DRY VALVE)

- Material: Nylon®
- Models:** Foot Control (OEM Part #38-0050-00), Foot Control II (OEM Part #38-0254-00), Foot Control III (OEM Part #'s 38.1601.00, 38.1603.00 & 38.1700.00), Foot Control 300 Series (OEM Part #38.1821.00), Foot Control 500 Series (OEM Part #38.1805.00) Foot Control Lever Action (OEM Part #38-0200-00)



RPI Part #ADP084
OEM Part #22-0083-00

PISTON

- Material: Brass
- Includes: (2 pcs) O-Rings (RPI Part #RPO302) and set screw
- Models:** Foot Control (OEM Part #38-0050-00)

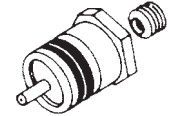

RPI Part #ADS004
OEM Part #29-0830-00

VALVE STEM (2-WAY)

- 2 per package
- Material: Plated brass
- Includes: (2 pcs) O-Rings (RPI Part #RPO309)
- Models:** Coolant Water Valve (OEM Part #22-0790-00 & 22-0960-00), 2-Way Toggle Valves & 2-Way Push Button Valve

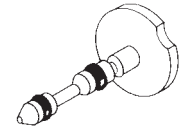

RPI Part #ADS093
OEM Part #22-0999-00

VALVE STEM

- Material: Brass
- Includes: (2 pcs) O-Ring (RPI Part #RPO309)
- Model:** Coolant Water Valve (OEM Part #22-0790-00 & 22-0960-00)



RPI Part #ADS100
OEM Part #29-0972-00

VALVE STEM

- 3 per package
- Material: Brass
- Includes: (1 pc) O-Ring (RPI Part #RPO319)
- Model:** Coolant Water Valve (OEM Part #22-0790-00 & 22-0960-00)

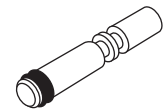

RPI Part #ADS101
OEM Part #22-0776-00

VALVE STEM

- 2 per package
- Material: Brass
- Includes: (1 pc) Quad Ring (RPI Part #RPO319)
- Model:** Coolant Water Valve (OEM Part #22-0790-00 & 22-0960-00)

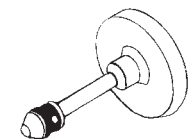

RPI Part #ADS092
OEM Part #30-0731-00

SHUT-OFF VALVE STEM

- Material: Brass
- Includes: (2 pcs) O-Ring (RPI Part #RPO307)
- #6-32 thread
- Fits:** Air-Operated Shut-Off Valve

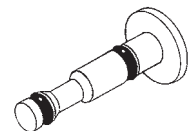

Dental Equipment

Cartridges, Pistons, Poppets & Stems *(continued)*

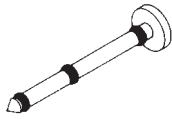

RPI Part #ADS008
OEM Part #33-0106-00

VALVE STEM

- Material: Brass
 - Includes: (3 pcs) O-Rings (RPI Part #RPO309)
- Fits:** Micro-Selector Valve

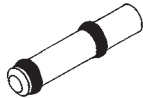

RPI Part #ADS009
OEM Part #38-0087-00

VALVE STEM

- 2 per package
 - Material: Brass
 - Includes: (2 pcs) O-Ring (RPI Part #RPO309)
- Fits:** Balanced 2-Way Micro-Valve (OEM Part #38-0086-00)

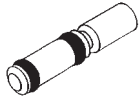

RPI Part #ADS002
OEM Part #29-0810-00

VALVE STEM

- 3 per package
 - Material: Brass
 - Includes: (2 pcs) O-Rings (RPI Part #RPO309)
- Fits:** 2-Way Micro-Valve (OEM Part #38-0062-00)

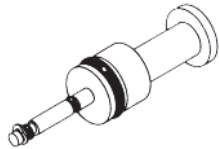

RPI Part #ADS059
OEM Part #40-0722-00

VACUUM VALVE STEM

- Material: Plated brass
 - Includes: (1 pc each) O-Rings (RPI Part #RPO302, RPO310, RPO311), and Retaining Ring (RPI Part #ADR043)
- Fits:** Vacuum Drain Actuator (OEM Part #40-0742-00) & Vacuum Sink Assembly (OEM Part #40-0200-00)

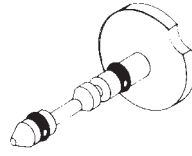

RPI Part #ADS006
OEM Part #29-0840-00

VALVE STEM (3-WAY)

- 3 per package
 - Material: Plated brass
 - Includes: (2 pcs) O-Rings (RPI Part #RPO309)
- Fits:** 3-Way Toggle Valve and Cartridge Valve

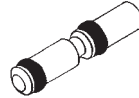

RPI Part #ADS003
OEM Part #29-0820-00

VALVE STEM

- 3 per package
 - Material: Brass
 - Includes: (2 pcs) O-Rings (RPI Part #RPO309)
- Fits:** 3-Way Micro-Valve (OEM Part #29-0185-00)

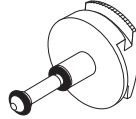

RPI Part #ADB070
OEM Part #10-0110-00

LOCKING BUTTON ASSEMBLY

- Material: Plated brass
 - Includes: (2 pcs) O-Ring (RPI Part #RPO309)
- Fits:** AVS Air Supply Tubing with Handpiece



RPI Part #ADP044
OEM Part #34-0003-00

VACUUM VALVE POPPET

- Material: Brass
 - Includes: (1 pc) O-Ring (RPI Part #RPO305)
- Fits:** Vacuum Drain Actuator (OEM Part #40-0742-00) & Vacuum Sink Assembly (OEM Part #40-0200-00)

NOTES: _____

RPI Part #RPL090
OEM Part #98.0090.01

HIGH TEMP LUBRICANT

- 5 per package; 1/2 gram per unit
- **For Non-silicone use only.** Do not use with highly oxidative chemicals (e.g. liquid chlorine, liquid oxygen, etc.).
- Temperature range: -40°F to +400°F (-40°C to +204°C)



RPI PART #RPK403

OEM Part # (No OEM Part # Available)

O-RING KIT

- Kit includes 8-compartment storage case (RPI Part #RPB414)
- O-Rings are also sold separately in quantities indicated below

RPI PART #	OEM PART #	X-SEC	ID	OD	IND PART #	MATERIAL	DURO	QTY
RPO301	No OEM # Available	.070	.489	.629	AS568-014	Nitrile (Buna N)	70	12
RPO302	030-013-00	.070	.426	.566	AS568-013	Nitrile (Buna N)	70	12
RPO303	030-012-00 & 030.012.01	.070	.364	.504	AS568-012	Nitrile (Buna N)	70	12
RPO304	030-011-00	.070	.301	.441	AS568-011	Nitrile (Buna N)	70	12
RPO305	030-010-00 & 030-010-02	.070	.239	.379	AS568-010	Nitrile (Buna N)	70	12
RPO306	No OEM # Available	.070	.176	.316	AS568-008	EPDM	70	12
RPO307	035 048 01*	.070	.114	.254	AS568-006	EPDM	70	12
RPO308	No OEM # Available	.040	.070	.150	5-051	Nitrile (Buna N)	70	12

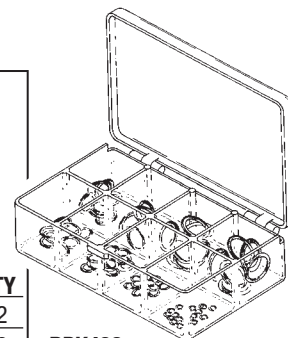

RPK403
O-RING KIT

* O-RING (RPI PART #RPO307) ALSO REFERS TO OEM PART# 030-006-02 Material: Nitrile (Buna N)

RPI PART #RPK404

OEM Part # (No OEM Part # Available)

O-RING KIT

- Kit includes 18-compartment storage case (RPI Part #RPB414)
- O-Rings are also sold separately in quantities indicated below

RPI PART #	OEM PART #	X-SEC	ID	OD	IND PART #	MATERIAL	DURO	QTY
RPO301	No OEM # Available	.070	.489	.629	AS568-014	Nitrile (Buna N)	70	12
RPO302	030-013-00	.070	.426	.566	AS568-013	Nitrile (Buna N)	70	12
RPO303	030-012-00 & 030.012.01	.070	.364	.504	AS568-012	Nitrile (Buna N)	70	12
RPO304	030-011-00	.070	.301	.441	AS568-011	Nitrile (Buna N)	70	12
RPO305	030-010-00 & 030-010-02	.070	.239	.379	AS568-010	Nitrile (Buna N)	70	12
RPO306	No OEM # Available	.070	.176	.316	AS568-008	EPDM	70	12
RPO307	035 048 01*	.070	.114	.254	AS568-006	EPDM	70	12
RPO308	No OEM # Available	.040	.070	.150	5-051	Nitrile (Buna N)	70	12
RPO309	030-001-00	.040	.029	.109	AS568-001	Nitrile (Buna N)	70	12
RPO310	030-002-00	.050	.042	.142	AS568-002	Nitrile (Buna N)	70	12
RPO311	030-003-00	.060	.056	.176	AS568-003	Nitrile (Buna N)	70	12
RPO312	030-004-00	.070	.070	.210	AS568-004	Nitrile (Buna N)	70	12
RPO313	030-005-00	.070	.101	.241	AS568-005	Nitrile (Buna N)	70	12
RPO314	No OEM # Available	.070	.145	.285	AS568-007	Nitrile (Buna N)	70	12
RPO315	030-009-00	.070	.208	.348	AS568-009	Nitrile (Buna N)	70	12
RPO316	030-015-00	.070	.551	.691	AS568-015	Nitrile (Buna N)	70	12
RPO317	030-016-00 & 030-016-02	.070	.614	.754	AS568-016	Nitrile (Buna N)	70	12
RPO318	033-006-00	.070	.676	.816	AS568-017	Nitrile (Buna N)	70	12

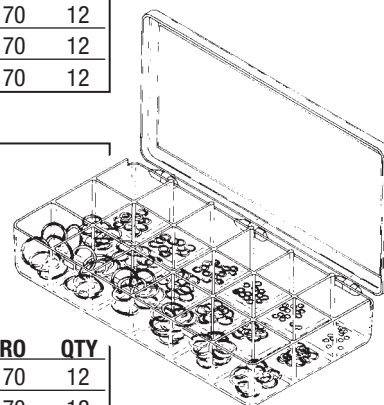

RPK404
O-RING KIT

RPI Part #RPL090
OEM Part #98.0090.01

HIGH TEMP LUBRICANT

- 5 per package
- 1/2 gram per unit

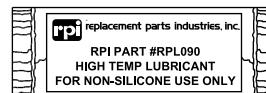

RPI Part #RPK481

OEM Part # 009-013-00

O-RING INSTALLATION TOOLS

- Three sizes
- Accommodates O-Rings with ID of .029" through .208"
- Stainless steel
- ~1-3/4" lg.

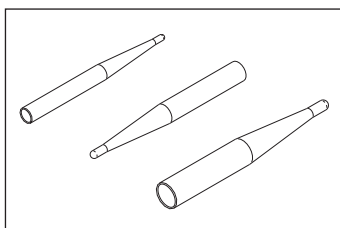

RPI Part #RPK581

OEM Part # (No OEM Part # Available)

O-RING REMOVAL TOOLS

- Pointed ends for hard to reach areas
- Blunt edges for larger surfaces
- Brass (to reduce potential o-ring groove damage)
- ~5-1/2" lg.

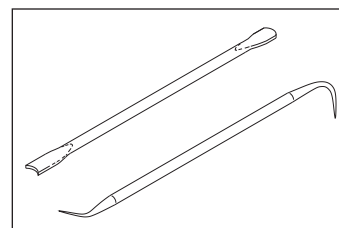

Dental Equipment

O-Rings, O-Ring Kits & Lubricant (continued)

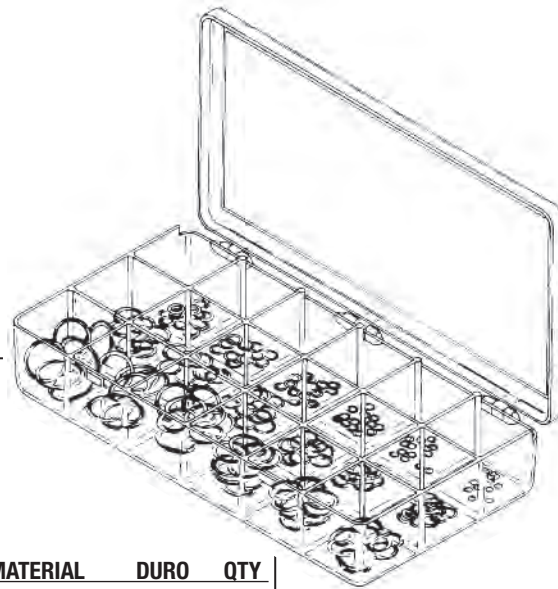

**RPK483
AUTOCLAVEABLE
O-RING KIT**

RPI PART #RPK483

OEM Part # (No OEM Part # Available)

AUTOCLAVEABLE O-RING KIT

- Kit includes 18-Compartment Storage Case (RPI Part #RPB417)
- O-Rings are also sold separately in quantities indicated below

RPI PART #	OEM PART #	X-SEC	ID	OD	IND PART #	MATERIAL	DURO	QTY
RPO307	035 048 01*	.070	.114	.254	AS568-006	EPDM	70	12
RPO326	033 014 01 & 033-014-00	.070	.489	.629	AS568-014	Viton	75	12
RPO444	034 019 01	.070	.801	.941	AS568-019	EPDM	70	12
RPO484	033.003.01	.060	.056	.176	AS568-003	Viton	75	12
RPO485	034 013 01, 030-013-01 & 030-013-02	.070	.426	.566	AS568-013	EPDM	70	12
RPO486	034.002.01	.050	.042	.142	AS568-002	EPDM	70	12
RPO487	034 003 01	.060	.056	.176	AS568-003	EPDM	70	12
RPO488	034-014-01 & 034-014-02	.070	.489	.629	AS568-014	EPDM	70	12
RPO489	035 033 01	.070	.101	.241	AS568-005	EPDM	70	12
RPO490	034 018 02	.070	.739	.879	AS568-018	EPDM	70	12
RPO491	034-107-00 & 034-107-01	.103	.206	.412	AS568-107	EPDM	70	12
RPO492	035 029 01	.070	.208	.348	AS568-009	Silicone	70	12
RPO493	034 001 00	.038	.032	.108	Custom	EPDM	70	12
RPO494	035 049 01	.040	.176	.256	Custom	EPDM	70	12
RPO495	035 009 01	.062	.400	.520	Custom	Viton	75	12
RPO496	035 050 01	.040	.070	.150	Custom	EPDM	70	12
RPO497	035 030 01	.040	.176	.256	Custom	Viton	75	12
RPO498	034-012-01	.070	.364	.504	AS568-012	EPDM	70	12

* O-RING (RPI PART #RPO307) ALSO REFERS TO OEM PART# 030-006-02 Material: Nitrile (Buna N)

**RPI Part #RPK481
OEM Part # 009-013-00**

O-RING INSTALLATION TOOLS

- Three sizes
- Accommodates O-Rings with ID of .029" through .208"
- Stainless steel
- ~1-3/4" lg.

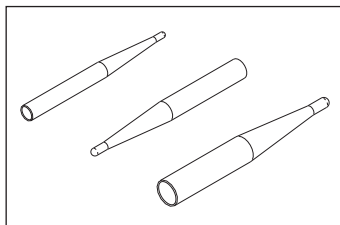

**RPI Part #RPK581
OEM Part # (No OEM Part # Available)**

O-RING REMOVAL TOOLS

- Pointed ends for hard to reach areas
- Blunt edges for larger surfaces
- Brass (to reduce potential o-ring groove damage)
- ~5-1/2" lg.

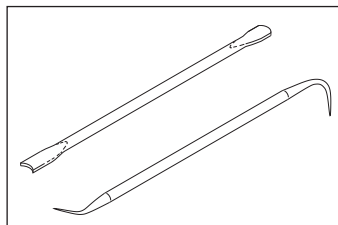

**RPI Part #RPL090
OEM Part #98.0090.01**

HIGH TEMP LUBRICANT

- 5 per package; 1/2 gram per unit
- **For Non-silicone use only. Do not use with highly oxidative chemicals (e.g. liquid chlorine, liquid oxygen, etc.).**
- Temperature range: -40°F to +400°F (-40°C to +204°C)



RPI Part #RP0319
OEM Part #035-003-00
Industry Part #Q4001

QUAD RING

- 12 per package
- Buna-N (Nitrile), 70 Duro
- .028" ID x .110" OD x .041" C/S



RPI Part #RP0752
OEM Part #035.034.01

O-RING

- 12 per package
- Material: Nitrile (Buna N); 70 Duro
- Size: .098" ID x .177" OD x .039" C/S
- Fits:** Drive Air Stem (RPI Part #ADS235)



RPI Part #RP0327
OEM Part #035-019-00
Industry Part #AS568-008

O-RING

- 12 per package
- Natural Silicone, 70 Duro
- .176" ID x .316" OD x .070" C/S



RPI Part #RP0325
OEM Part #030-019-00
Industry Part #AS568-019

O-RING

- 12 per package
- Buna-N (Nitrile), 70 Duro
- .801" ID x .941" OD x .070" C/S

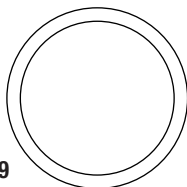

It's the RPI Advantage!

Please take a moment to refer to **General Shop Aids, Section 6** – there you will find several charts that will assist you in sizing O-rings and determining proper O-ring material should you need a quick reference for identification of an O-ring.

RPI Part #RP0322
OEM Part #030-023-02
Industry Part #AS568-023

O-RING

- 12 per package
- Buna-N (Nitrile), 70 Duro
- 1.051" ID x 1.191" OD x .070" C/S

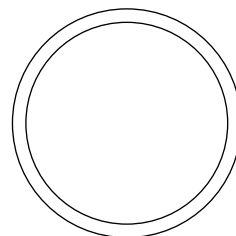

RPI Part #RP0321
OEM Part #030-034-02
Industry Part #AS568-034

O-RING

- 12 per package
- Buna-N (Nitrile), 70 Duro
- 2.114" ID x 2.254" OD x .070" C/S

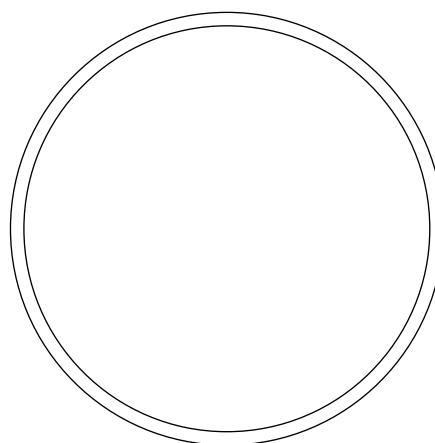

O-Ring illustrations are actual size

RPI Part #RPK481
OEM Part # 009-013-00

O-RING INSTALLATION TOOLS

- Three sizes
- Accommodates O-Rings with ID of .029" through .208"
- Stainless steel
- ~1-3/4" lg.

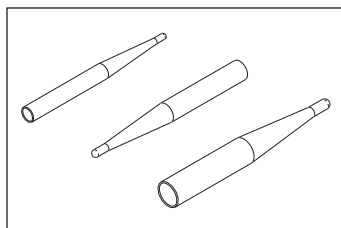

RPI Part #RPK581
OEM Part # (No OEM Part # Available)

O-RING REMOVAL TOOLS

- Pointed ends for hard to reach areas
- Blunt edges for larger surfaces
- Brass (to reduce potential o-ring groove damage)
- ~5-1/2" lg.

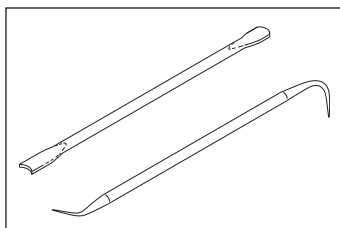

RPI Part #RPL090
OEM Part #98.0090.01

HIGH TEMP LUBRICANT

- 5 per package; 1/2 gram per unit
- **For Non-silicone use only.** Do not use with highly oxidative chemicals (e.g. liquid chlorine, liquid oxygen, etc.).
- Temperature range: -40°F to +400°F (-40°C to +204°C)

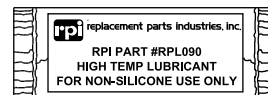

Dental Equipment

Screws & Screw Kits

**Perfect Kit when servicing
components of Dental Delivery
Systems & Units**

**RPI PART #ADK110
SOCKET HEAD CAP SCREW KIT**

- Kit includes 12-Compartment Storage Case (RPI Part #RPB416)
 - Hardware is also sold separately in quantities indicated below
- Fits:** Various components of A-dec dental delivery systems and units

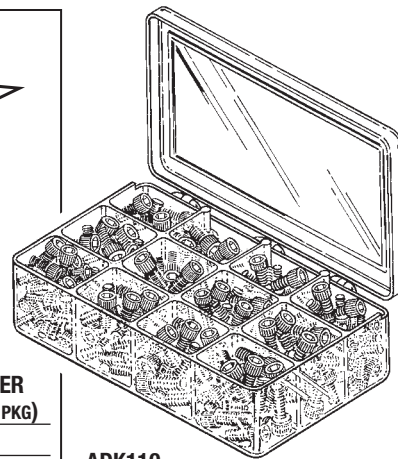

**ADK110
SOCKET HEAD CAP
SCREW KIT**

RPI PART #	OEM PART #	SIZE	MATERIAL	KIT QTY	REORDER QTY (PER PKG)
ADS053	001-034-00	#6-32 x 1/4" lg.	Stainless Steel	10	10
ADS111	001-033-00	#6-32 x 3/8" lg.	Stainless Steel	25	25
ADS112	001-042-00	#6-32 x 1/2" lg.	Stainless Steel	25	25
ADS113	001-010-00	#6-32 x 5/8" lg.	Stainless Steel	25	25
ADS114	001-026-00	#6-32 x 7/8" lg.	Stainless Steel	25	25
ADS115	002-011-00	#6-32 x 1" lg.	Stainless Steel	25	25
ADS116	003-078-00	#4-40 x 1/4" lg.	Stainless Steel	25	25
ADS117	001-024-00	#4-40 x 3/8" lg.	Stainless Steel	25	25
ADS118	001-021-00	#4-40 x 1/2" lg.	Stainless Steel	25	25
ADS119	002-024-00	#4-40 x 3/4" lg.	Stainless Steel	25	25
ADS120	001-070-00	#2-56 x 1/2" lg.	Stainless Steel	25	25
ADS121	001-089-00	1/4-20 x 5/8" lg.	Stainless Steel	15	15

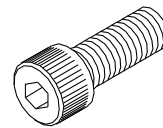

**SOCKET HEAD
CAP SCREW**

**RPI Part #RPT539
L-HEX WRENCH SET (METRIC)**

- 9 piece set
- 1.5 mm through 10 mm
- Corrosion protected steel
- Made by Bondhus®

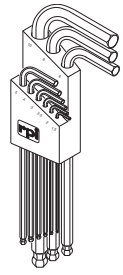

**RPI Part #RPT540
L-HEX WRENCH SET (INCH)**

- 13 piece set
- .050" through 3/8"
- Corrosion protected steel
- Made by Bondhus®

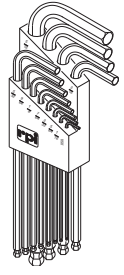

**RPI Part #RPA032
THREADLOCKER 242**

- 5 per package
- .02 fl. oz. per unit
- Prevents rust and corrosion
- Removable adhesive by Loctite®
- MSDS and Technical Data sheet available on RPI website

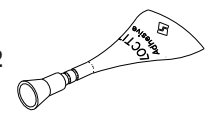

NOTES: _____



RPI Part #RPH743
OEM Part #003.031.00

PHILLIPS PAN HEAD SCREW #4

- 25 per package
 - Material: Zinc plated steel
 - Size: #4 Self Tapping Screw x 1/2" lg.
- Models:** Foot Control (OEM Part #38-0050-00), Foot Control II (OEM Part #38-0254-00), Foot Control III (OEM Part #'s 38.1601.00, 38.1603.00 & 38.1700.00), Foot Control 300 Series (OEM Part #38.1821.00), Foot Control 500 Series (OEM Part #38.1805.00) & Foot Control Lever Action (OEM Part #38-0200-00)



RPI Part #RPH742
OEM Part #003.0221.00

PHILLIPS PAN HEAD SCREW #6

- 25 per package
 - Material: Zinc plated steel
 - Size: #6 Self Tapping Screw x 1/2" lg.
- Models:** Foot Control (OEM Part #38-0050-00), Foot Control II (OEM Part #38-0254-00), Foot Control III (OEM Part #'s 38.1601.00, 38.1603.00 & 38.1700.00), Foot Control 300 Series (OEM Part #38.1821.00), Foot Control 500 Series (OEM Part #38.1805.00) & Foot Control Lever Action (OEM Part #38-0200-00)

RPI Part #ADS056
OEM Part #007-002-00 & 007.021.00



SOCKET HEAD SET SCREW

- 20 per package
 - Material: Stainless steel
 - Size: #6-32 x 3-16" lg.
- Models:** Foot Control (OEM Part #38-0050-00), Foot Control II (OEM Part #38-0254-00), Foot Control III (OEM Part #'s 38.1601.00, 38.1603.00 & 38.1700.00), Foot Control 300 Series (OEM Part #38.1821.00), Foot Control 500 Series (OEM Part #38.1805.00), Foot Control Lever Action (OEM Part #38-0200-00) & Trutorc & IC Handpiece Holders

RPI offers a wide selection of general shop aids including screws, nuts, bolts, washers, o-rings and more. Please see the General Shop Aids Section for details.

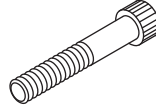

RPI Part #RPH741
OEM Part #001.102.00

SOCKET HEAD CAP SCREW

- 25 per package
 - Material: Stainless steel
 - Size: #4-40 x 7/8" lg.
- Models:** Foot Control (OEM Part #38-0050-00), Foot Control II (OEM Part #38-0254-00), Foot Control III (OEM Part #'s 38.1601.00, 38.1603.00 & 38.1700.00), Foot Control 300 Series (OEM Part #38.1821.00), Foot Control 500 Series (OEM Part #38.1805.00) & Foot Control Lever Action (OEM Part #38-0200-00)

RPI Part #ADS116
OEM Part #003-078-00



SOCKET HEAD CAP SCREW

- 25 per package
 - Material: Stainless steel
 - Size: #4-40 x 1/4" lg.
- Models:** Foot Control (OEM Part #38-0050-00), Foot Control II (OEM Part #38-0254-00), Foot Control III (OEM Part #'s 38.1601.00, 38.1603.00 & 38.1700.00), Foot Control 300 Series (OEM Part #38.1821.00), Foot Control 500 Series (OEM Part #38.1805.00) & Foot Control Lever Action (OEM Part #38-0200-00)

RPI Part #ADS054
OEM Part #001-073-00

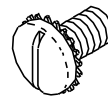

PAN HEAD SLOTTED SCREW

- 10 per package
 - Material: Stainless steel
 - Size: #6-32 x 1/4" lg.
- Fits:** End Cap, Excellence Arm Assembly & Flex Arm II

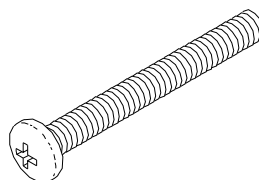

RPI Part #ADS109
OEM Part #001-023-00

PHILLIPS PAN HEAD MACHINE SCREW

- 25 per package
 - Material: Stainless steel
 - Size: #6-32 x 1-1/4" lg.
- Fits:** Vacuum Drain Actuator & Vacuum Sink Assembly



RPI Part #ADS169
OEM Part #002-118-00

BUTTON HEAD CAP SCREW

- 5 per package
 - Material: Stainless steel
 - Size: #4-40 x 3/16" lg.
- Can be used on all one piece hydraulic manifolds to retain flow adj. screws
- Model:** Handpiece Control Block Century Plus (OEM Part #38.0540.00)

RPI Part #ADS052
OEM Part #001-002-00

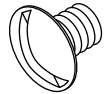

TRUSS HEAD SLOTTED SCREW

- 10 per package
 - Material: Stainless steel
 - Size: #2-56 x 1/8" lg.
- Models:** Handpiece Control Block Century II (OEM Part #38.0223.00), Handpiece Control Block Century Plus (OEM Part #38.0540.00), Handpiece Control Block Century Water Valve System (OEM Part #38.0098.00) & Tooth Dryer End Cap

RPI Part #ADS097
OEM Part #002-097-00

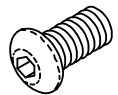

BUTTON HEAD SCREW

- 12 per package
 - Material: Stainless steel
 - Size: #4-40 x 1/4" lg.
- Model:** Handpiece Control Block Century II (OEM Part #38.0223.00)

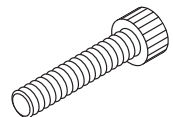

RPI Part #RPH740
OEM Part #001.240.00

SOCKET HEAD CAP SCREW

- 25 per package
 - Material: Stainless steel
 - Size: #6-32 x 3/4" lg.
- Models:** Handpiece Control Block 300 Series (OEM Part #38.1831.00) & 500 Series (OEM Part #38.1776.00)

RPI Part #ADS108
OEM Part #007-010-00



SOCKET HEAD SET SCREW

- 25 per package
 - Material: Stainless steel
 - Size: #4-40 x 1/8" lg.
- Model:** Handpiece Control Block Century Water Valve Assembly (OEM Part #38.0098.00)

Dental Equipment

Saliva Ejector Tips

RPI Part #ADT151
OEM Part #12-0183-01

SALIVA EJECTOR TIP (GRAY)

- 2 per package
 - Medical Grade Silicone; Autoclaveable
 - Color: Gray; Push-On Type
- Fits:** All Saliva Ejector Valves (Push On Type)



RPI Part #ADT060
OEM Part #12-0183-00

SALIVA EJECTOR TIP (BLACK)

- 2 per package
 - Medical Grade Silicone; Autoclaveable
 - Color: Black; Push-On Type
- Fits:** All Saliva Ejector Valves (Push On Type)



Vacuum Systems Parts & Kit

RPI Part #ADK033
OEM Part #90-0319-00

VACUUM DRAIN KNOB SERVICE KIT

- Includes all parts as shown
- Fits:** Vacuum Drain Actuator (OEM Part #40-0742-00) & Vacuum Sink Assembly (OEM Part #55-0200-00)

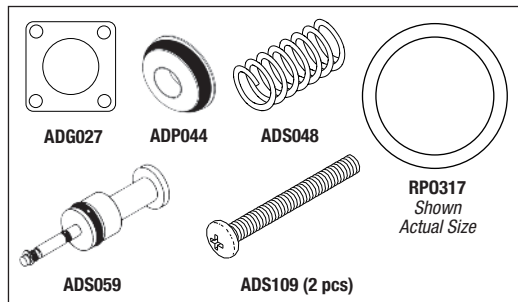

RPI Part #ADC073
OEM Part #028-008-00

PLUG CAP

- 10 per package
 - 1/2" OD x 1/4" ID
 - Plastic (Red)
- Fits:** Central Vacuum Solids Separators

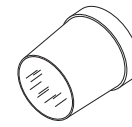

RPI Part #RP0485
OEM Part #034 013 01
Industry Part #AS568-013

O-RING

- 12 per package
 - Material: EPDM, Hardness: 70 Duro
 - Size: .426" ID x .566" OD x .070" C/S
- Fits:** High Vacuum Evacuation: Tip

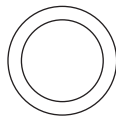

RPI Part #RP0444
OEM Part #034 019 01
Industry Part #AS568-019

O-RING

- 12 per package
 - Material: EPDM, Hardness: 70 Duro
 - Size: .801" ID x .941" OD x .070" C/S
- Fits:** High Vacuum Evacuation: Body & Rotor

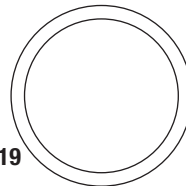

RPI Part #RP0305
OEM Part #030-010-00
Industry Part #AS568-010

O-RING

- 12 per package
 - Material: Nitrile (Buna N), Hardness: 70 Duro
 - Size: .239" ID x .379" OD x .070" C/S
- Fits:** Saliva Ejector: Rotor



RPI Part #RP0488
OEM Part #034-014-01
Industry Part #AS568-014

O-RING

- 12 per package
 - Material: EPDM, Hardness: 70 Duro
 - Size: .489" ID x .625" OD x .070" C/S
- Fits:** High Vacuum Evacuation: Rotor

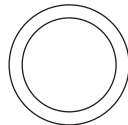

RPI Part #RP0498
OEM Part #034 012 01
Industry Part #AS568-012

O-RING

- 12 per package
 - Material: EPDM, Hardness: 70 Duro
 - Size: .364" ID x .504" OD x .070" C/S
- Fits:** High Vacuum Evacuation: Body & Rotor

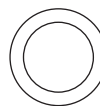

RPI Part #RP0317
OEM Part #030-016-00
Industry Part #AS568-016

O-RING

- 12 per package
 - Material: Nitrile (Buna N), Hardness: 70 Duro
 - Size: .614" ID x .754" OD x .070" C/S
- Models:** High Vacuum Evacuation: Rotor, Vacuum Drain Actuator (OEM Part #40-0742-00) & Vacuum Sink Assembly (OEM Part #55-0200-00)

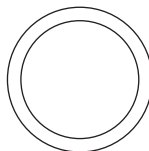

RPI Part #RP0491
OEM Part #034 107 00
Industry Part #AS568-107

O-RING

- 12 per package
 - Material: EPDM, Hardness: 70 Duro
 - Size: .206" ID x .412" OD x .103" C/S
- Fits:** Saliva Ejector: Tip



RPI Part #RP0321
OEM Part #030-034-00
Industry Part #AS568-034

O-RING

- 12 per package
 - Material: Nitrile (Buna N), Hardness: 70 Duro
 - Size: 2.114" ID x 2.254" OD x .070" C/S
- Fits:** Solids Collector Lid

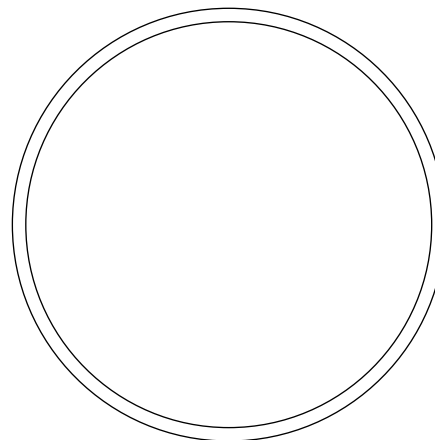

O-Ring illustrations are actual size

**RPI Part #ADS082
OEM Part #22-0040-00**



HELICAL COMPRESSION SPRING

- 10 per package
 - Material: Stainless steel
 - Size: .306" OD x .250" lg. x .026" wire dia.
- Models:** Foot Control (OEM Part #38-0050-00), Foot Control II (OEM Part #38-0254-00), Foot Control III (OEM Part #'s 38.1601.00, 38.1603.00, & 38.1700.00), Foot Control Lever Action (OEM Part #38-0200-00), Foot Control 300 Series (OEM Part #38.1821.00) & Foot Control 500 Series (OEM Part #38.1805.00)

**RPI Part #ADS081
OEM Part #10-0440-00**



HELICAL COMPRESSION SPRING

- 10 per package
 - Material: Stainless steel
 - Size: .092" OD x .230" lg. x .010" wire dia.
- Models:** Foot Control (OEM Part #38-0050-00), Foot Control II (OEM Part #38-0254-00), Foot Control III (OEM Part #'s 38.1601.00, 38.1603.00, & 38.1700.00), Foot Control Lever Action (OEM Part #38-0200-00), Foot Control 300 Series (OEM Part #38.1821.00) & Foot Control 500 Series (OEM Part #38.1805.00)

**RPI Part #ADS091
OEM Part #013-011-00**

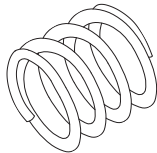

HELICAL COMPRESSION SPRING

- 10 per package
 - Material: Stainless steel
 - Size: .721" OD x .520" lg. x .060" wire dia.
- Fits:** Foot Control II (OEM Part #38-0254-00), Foot Control III (OEM Part #'s 38.1601.00, 38.1603.00, & 38.1700.00), Foot Control 300 Series (OEM Part #38.1821.00) & Foot Control 500 Series (OEM Part #38.1805.00)

**RPI Part #ADS086
OEM Part #22-0580-00**

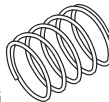

HELICAL COMPRESSION SPRING

- 10 per package
 - Material: Stainless steel
 - Size: .300" OD x .380" lg. x .024" wire dia.
- Models:** Foot Control (OEM Part #38-0050-00), Foot Control III (OEM Part #'s 38.1601.00, 38.1603.00, & 38.1700.00), Foot Control 300 Series (OEM Part #38.1821.00) & Foot Control 500 Series (OEM Part #38.1805.00)

**If it's an RPI part,
it's a part you
can trust.**

**RPI Part #ADS085
OEM Part #22-0135-00**



HELICAL COMPRESSION SPRING

- 10 per package
 - Material: Stainless steel
 - Size: 1.350" OD x .680" lg. x .063" wire dia.
- Model:** Foot Control (OEM Part #38-0050-00)

**RPI Part #ADS046
OEM Part #013-025-00**



HELICAL COMPRESSION SPRING

- 10 per package
 - Material: Stainless steel
 - Size: .245" OD x .260" lg. x .022" wire dia.
- Model:** Foot Control II (OEM Part #38-0254-00) & Handpiece Control Block Century II (OEM Part #38.0223.00)

**RPI Part #ADS045
OEM Part #013-022-00**

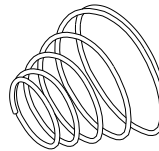

CONICAL COMPRESSION SPRING

- 10 per package
 - Material: Green chromate plated steel
 - Size: .208"/.480" OD x .460" lg. x .030" wire dia.
- Model:** Foot Control II (OEM Part #38-0254-00)

**RPI Part #ADS104
OEM Part #013-019-00**



HELICAL COMPRESSION SPRING

- 10 per package
 - Material: Stainless steel
 - Size: .180" OD x .500" lg. x .016" wire dia.
- Model:** Foot Control Lever Action (OEM Part #38-0200-00)

**RPI Part #ADS105
OEM Part #38-0208-00**

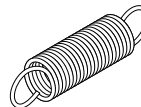

EXTENSION SPRING

- 10 per package
 - Material: Stainless steel
 - Size: .260" OD x 1.025" lg. x .016" wire dia.
- Model:** Foot Control Lever Action (OEM Part #38-0200-00)

**RPI Part #ADS102
OEM Part #22-0460-00**



CONICAL COMPRESSION SPRING

- 10 per package
 - Material: Stainless steel
 - Size: .293"/.252" OD x .350" lg. x .016" wire dia.
- Models:** Coolant Air Valve (OEM Part #22-0940-00), Coolant Water Valve (OEM Part #22-0960-00/22-0790-00) & Air Regulator Valve "White" Bodies (OEM Part #24-0135-00)

**RPI Part #ADS103
OEM Part # (No OEM Part # Available)**



HELICAL COMPRESSION SPRING

- 10 per package
 - Material: Stainless steel
 - Size: .318" OD x .550" lg. x .033" wire dia.
- Models:** Air Filter Regulator (OEM Part #026-021-01) & Water Filter Regulator (OEM Part #40-0654-00)

**RPI Part #ADS062
OEM Part #19-0230-00**

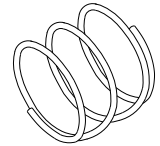

HELICAL COMPRESSION SPRING

- 10 per package
 - Material: Stainless steel
 - Size: .565" OD x .625" lg. x .032" wire dia.
- Models:** Air and Water Shut-Off Valve (Air Operated) (OEM Part #30-0330-00) & Water Filter Regulator (OEM Part #40-0654-00)

**RPI Part #ADS156
OEM Part #013-032-00**

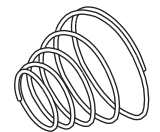

SPRING (CONICAL COMPRESSION)

- 10 per package
 - Material: Stainless steel
 - Size: .260"/.355" OD x .390" lg. x .022" wire dia.
- Model:** Water Regulator Valve "Black" Bodies (OEM Part #24-0355-00)

**RPI Part #ADS195
OEM Part #013-021-00**



COMPRESSION SPRING

- 10 per package
 - Material: Stainless steel
 - Size: .243" OD x .420" lg. x .016" wire dia.
- Model:** Handpiece Control Block Century Plus (OEM Part #38.0540.00)

**RPI Part #ADS048
OEM Part #013-004-00**

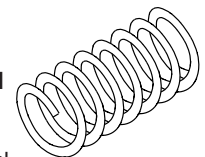

HELICAL COMPRESSION SPRING

- 10 per package
 - Material: Stainless steel
 - Size: .420" OD x .860" lg. x .038" wire dia.
- Fits:** Vacuum Drain Actuator & Vacuum Sink Assembly

**RPI Part #ADS047
OEM Part #013-038-01 / 013.064.01**



CONICAL COMPRESSION SPRING

- 10 per package
 - Material: Stainless steel
 - Size: .125"/.250" OD x .250" lg. x .018" wire dia.
- Fits:** Lever, Soft Touch Button & Continental Syringe

Dental Equipment

Retaining Springs & Rings



RPI Part #ADR253
OEM Part #010.056.00



RETAINING SPRING

- 3 per package
- Material: Stainless Steel
- Size: .62" ID

Models: Foot Control (OEM Part #38-0050-00), Foot Control II (OEM Part #38-0254-00), Foot Control III (OEM Part #'s 38.1601.00, 38.1603.00, & 38.1700.00), Foot Control Lever Action (OEM Part #38-0200-00), Foot Control 300 Series (OEM Part #38.1821.00) & 500 Series (OEM Part #38.1805.00)



RPI Part #ADR240
OEM Part #38.1779.01



RETAINING RING

- 5 per package
- Material: Plastic

Models: Handpiece Control Block 300 Series (OEM Part #38.1831.00) & 500 Series (OEM Part #38.1776.00)

RPI offers a wide selection of general shop aids including screws, nuts, bolts, washers, o-rings and more. Please see the General Shop Aids Section for details.

RPI Part #ADR043
OEM Part #010-019-00



RETAINING RING (EXTERNAL)

- 10 per package
- Fits: .125" dia. shaft
- Also available Vacuum Valve Stem (RPI Part #ADS059)

Fits: Vacuum Sink Assembly, Lever Syringe, Soft Touch Button Syringe & Vacuum Drain Actuator

RPI Part #ADR041
OEM Part #010-013-00



RETAINING RING (INTERNAL)

- 10 per package
 - Fits: .375" dia. hole
- Fits:** Air and Water Shut-Off Valve (Air Operated) (OEM Part #30-0330-00), Foot Control Lever Action (OEM Part #38-0200-00), Needle Valves, and Cartridge Valves

Syringe Parts

RPI Part #ADR043
OEM Part #010-019-00



RETAINING RING (EXTERNAL)

- 10 per package
- Size: .094" ID
- Fits: .125" dia. shaft
- Also in Vacuum Drain Knob Service Kit (RPI Part #ADK033)

Fits: Vacuum Sink Assembly, Lever Syringe, Soft Touch Button Syringe & Vacuum Drain Actuator

RPI Part #ADR042
OEM Part #010-017-00



RETAINING RING (INTERNAL)

- 10 per package
- Size: .250" OD
- Also in Lever Action Foot Control Service Kit (RPI Part #AKD122)

Fits: Drip Syringe & Faucet Assembly

RPI offers a wide selection of general shop aids including screws, nuts, bolts, washers, o-rings and more. Please see the General Shop Aids Section for details.

RPI Part #ADP050
OEM Part #011-038-00

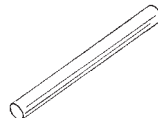

STRAIGHT PIN

- 10 per package
- Material: Stainless steel
- Size: .062 dia. x .430" lg.

Fits: Micro-Selector Valve, 2-Way Routing Selector Valve, 2-Way and 3-Way Toggle Valve & Autoclavable and Continental Syringes

RPI Part #ADS064
OEM Part #23-0886-00

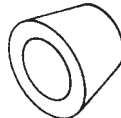

SWIVEL SLEEVE

- 5 per package
 - Material: Brass
- Fits:** Uni-Flo and Tri-Flo Syringe Nut

RPI Part #ADS047
OEM Part #013-038-01 / 013.064.01

CONICAL COMPRESSION SPRING

- 10 per package
- Size: .125/.250" OD x .250" lg. x .018" wire dia.
- Material: Stainless steel

Fits: Lever, Soft Touch Button & Continental Syringe



RPI Part #RPO307
OEM Part #030-006-03/030.006.02
Industry Part #AS568-006/2-006



O-RING

- 12 per package
 - Material: EPDM. Hardness: 70 Duro
 - Size: .114" ID x .254" OD x .070" C/S
- Fits:** Syringe (Rear Adapter)

RPI Part #RPO487
OEM Part #034 003 01
Industry Part #AS568-003



O-RING

- 12 per package
 - Material: EPDM, Hardness: Duro 70
 - Size: .056" ID x .176" OD x .060" C/S
- Fits:** Syringe (Nut)

RPI Part #RPO310
OEM Part #030-002-00
Industry Part #AS568-002



O-RING

- 12 per package
 - Material: Nitrile (Buna N), Hardness: Duro 70
 - Size: .042" ID x .142" OD x .050" C/S
- Fits:** Syringe (Non-Quick Disconnect Barb)

RPI Part #RPT264
OEM Part # (No OEM Part # Available)

Made from stainless steel for greater durability and a longer life than similar aluminum core tool.

VALVE CORE REMOVAL/SYRINGE TOOL

- Long Allen 3/32; Short Allen 5/32
- Stainless steel
- Syringe repair tool
- Removal tool for use with Valve Core (RPI Part #ADV001)

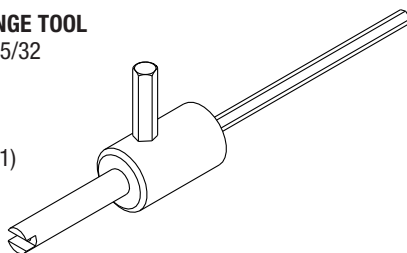

RPI Part #ADV001
OEM Part #026-033-01

VALVE CORE (SHORT)

- 12 per package
- Now has red banding instead of black

Models: Handpiece Control Block Century Water Valve Assembly (OEM Part #38.0098.00), Air Filter Regulator (OEM Part #26-021-01), Filters/Moisture Separator (OEM Part #026-066-00), Tri-Flo Syringe & Uni-Flo Syringe,

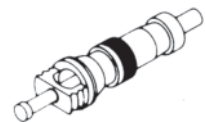

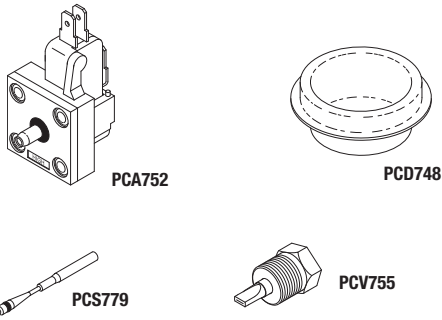

All Parts in Kit Also Sold Separately!

RPI Part #PCK780
OEM Part # (No OEM Part # Available)

FOOT CONTROL VALVE KIT
 • Includes all parts as shown
Fits: Foot Control Valve Block Assembly
Models: Spirit, Spirit II, Spirit IIE & Spirit EC

RPI Part #PCA752
OEM Part #33 03 042/51 74 052

MICRO-SWITCH & DIAPHRAGM ASSEMBLY

• Plastic
 • Includes O-ring (RPI Part #RPO314)
Fits: Foot Control Valve Block Assembly
Models: Spirit, Spirit II, Spirit IIE & Spirit EC

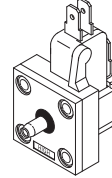

RPI Part #PCS779
OEM Part #33 03 067

STEM

• .092" dia. x 1.440" lg.
 • Stainless Steel
 • Includes Stem O-ring (RPI Part #RPO310)
Fits: Foot Control Valve Block Assembly
Models: Spirit, Spirit II, Spirit IIE & Spirit EC

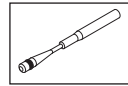

RPI Part #PCV755
OEM Part #33 03 000

CHECK VALVE ASSEMBLY

• Body of valve is brass
 • Duckbill is Buna-N
Fits: Foot Control Valve Block Assembly
Models: Spirit, Spirit II, Spirit IIE & Spirit EC

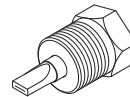

RPI Part #PCD748
OEM Part #33 02 978

REGULATOR DIAPHRAGM

• Acrylonitrile-Butadiene rubber
Fits: Foot Control Valve Block Assembly
Models: Spirit, Spirit II, Spirit IIE & Spirit EC

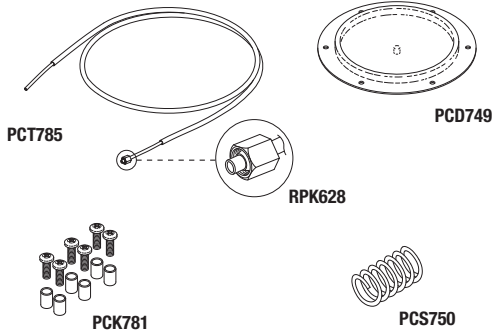
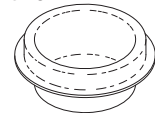

All Parts in Kit Also Sold Separately!

RPI Part #PCK784
OEM Part # (No OEM Part # Available)

FOOT CONTROLLER REPAIR KIT
 • Includes all parts as shown
Fits: Foot Controller Assembly
Models: Spirit, Spirit II, Spirit IIE & Spirit EC

RPI Part #PCD749
OEM #33 02 853

FOOT SWITCH DIAPHRAGM

• 3.188" dia.; Nylon fabric reinforced nitrile
Fits: Foot Controller Assembly
Models: Spirit, Spirit II, Spirit IIE & Spirit EC

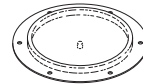

RPI Part #PCT785
OEM #: 023725

FOOT CONTROLLER TUBING ASSEMBLY

• Includes Foot Controller Tubing - 8 ft. (RPI Part #PCT786) and Compression Nut & Sleeve - 1/8" (RPI Part #RPK628)
Fits: Foot Controller Assembly
Models: Spirit, Spirit II, Spirit IIE & Spirit EC

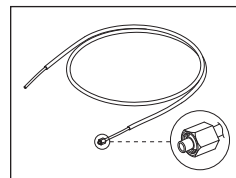

RPI Part #PCS750
OEM #33 02 879

CUSHION SPRING

• .475" OD x .750" lg. x .042" dia. music wire
Fits: Foot Controller Assembly
Models: Spirit, Spirit II, Spirit IIE & Spirit EC



RPI Part #PCK781
OEM Part # (No OEM Part # Available)

FOOT CONTROLLER SPACER KIT

• Includes: (6) brass spacers .190" ID x .218" OD x .312" lg. and (6) Phillips Pan Head Screws #8-32 x 1/2" lg. (RPI Part #RPH102)
Fits: Foot Controller Assembly
Models: Spirit, Spirit II, Spirit IIE & Spirit EC

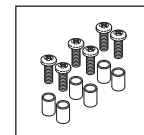

RPI Part #RPK628
OEM Part # (No OEM Part # Available)

COMPRESSION NUT & SLEEVE - 1/8"

• 10 per package; Brass; For use with 1/8" OD tube
 • Included in Foot Controller Tubing Assembly (RPI Part #PCT785)
Fits: Foot Controller Tubing
Models: Spirit, Spirit II, Spirit IIE & Spirit EC

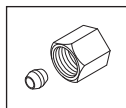

RPI Part #PCT786
OEM Part # (No OEM Part # Available)

FOOT CONTROLLER TUBING

• 25 ft. (tubing can be cut for custom applications)
 • Silicone rubber sheath with polyurethane 1/8" OD inner tubing
Fits: Foot Controller Assembly or any 1/16" OD barb
Models: Spirit, Spirit II, Spirit IIE & Spirit EC

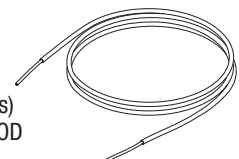

Dental Equipment

Models: Spirit®, Spirit® II, Spirit® IIE, Spirit® AC & Spirit® EC

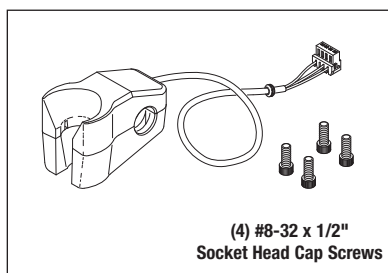

RPI Part #PCK776
New OEM #33 22 315 (Assy.),
15 35 546 (Top) & 15 35 827 (Bottom)
HANDPIECE HANGER ASSEMBLY (WHITE)

- White Nylon
- Photo-interrupter sensor with connector
- Includes all parts as shown

Fits: Delivery Units
Models: Spirit IIE & Spirit EC (prior to October, 1993)

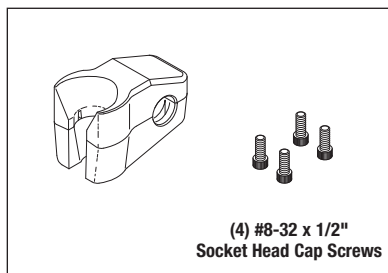

RPI Part #PCK778
OEM Part #33 39 889 (Assy.),
15 24 813 (Top) & 15 35 827 (Bottom)
SYRINGE HANGER ASSEMBLY (WHITE)

- White Nylon
- Includes all parts as shown

Fits: Delivery Units
Models: Spirit IIE & Spirit EC (prior to October, 1993)

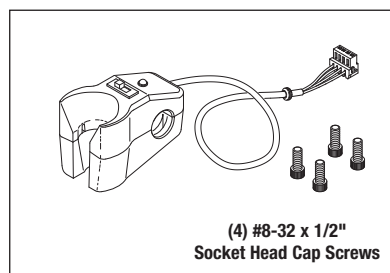

RPI Part #PCK732
OEM Part #021814 (Assy.),
020282 (Top) & 020185 (Bottom)
HANDPIECE HANGER ASSEMBLY (BLACK)

- Black Nylon
- On-off switch with LED
- Photo-interrupter sensor with connector
- Includes all parts as shown

Fits: Delivery Units
Models: Spirit (1983-1990) & Spirit II (1990-1995)

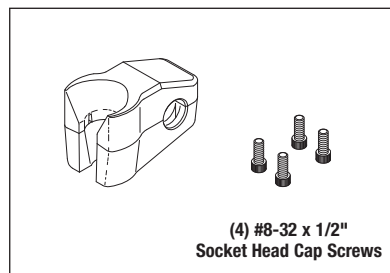

RPI Part #PCK741
OEM Part #021813 (Assy.),
020547 (Top) & 020185 (Bottom)
SYRINGE HANGER ASSEMBLY (BLACK)

- Black Nylon
- Includes all parts as shown

Fits: Delivery Units
Models: Spirit (1983-1990) & Spirit II (1990-1995)

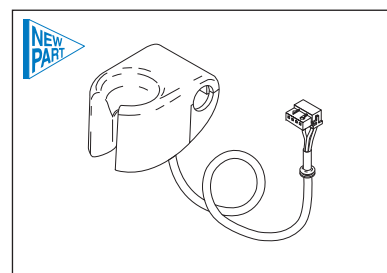

RPI Part #PCK759
OEM Part #15 32 535
HANDPIECE HANGER ASSEMBLY

- White Nylon
- Photo-interrupter sensor with connector
- Two anti-rotational inserts
- Includes (2) mounting screws

Fits: Delivery Unit Handpiece Rail
Models: Spirit EC (After Oct, 1993)

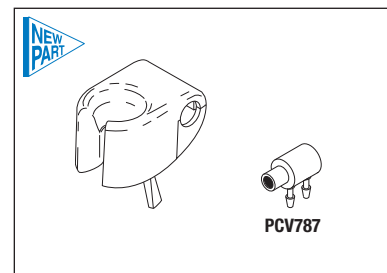

RPI Part #PCK783
OEM Part #33 39 970
HANDPIECE HANGER ASSEMBLY

- White Nylon
- Autoholder Valve (RPI Part #PCV787)
- Two anti-rotational inserts
- Includes (2) mounting screws

Fits: Delivery Unit Handpiece Rail
Models: Spirit AC

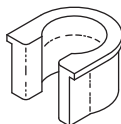

RPI Part #PCI753
OEM Part #020892
INSERT (SYRINGE)

- Black Nylon

Fits: Assistant's Holders (both manual and automatic activation units)
Models: Spirit, Spirit II, Spirit IIE, Spirit AC & Spirit EC

Visit the RPI website:
www.rpiparts.com

Order parts online:
order@rpiparts.com

FREE Tech Support
 (800) 221-9723



RPI Part #PCV787
OEM Part #33 07 431
AUTOHOLDER VALVE

- Nickel plated brass
- Normally closed
- 1/16" barb

Fits: Handpiece Hanger Assembly
Model: Spirit AC

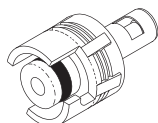

RPI Part #PCC773
OEM Part #94 33 533

MALE QUICK CONNECT (1/16")

- Barb fits 1/16" ID tubing
- Twist to connect
- Coupling rotates freely
- Material: Delrin®
- Mates with Female Quick Connect (1/16") (RPI Part #PCC772)

Fits: Delivery Unit
Model: Spirit AC

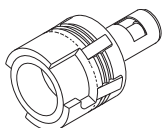

RPI Part #PCC772
OEM Part #94 33 541

FEMALE QUICK CONNECT (1/16")

- Barb fits 1/16" ID tubing
- Twist to connect
- Coupling rotates freely
- Material: Delrin®
- Mates with Male Quick Connect (1/16") (RPI Part #PCC773)

Fits: Delivery Unit
Model: Spirit AC

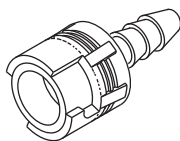

RPI Part #PCC756
OEM Part #94 33 525

IN-LINE COUPLING (1/8")

- Barb fits 1/8" ID tubing
- Twist to connect
- Coupling rotates freely
- Material: Delrin®
- Mates with Male Quick Disconnect (1/8") (RPI Part #PCC757)

Fits: Foot Control Valve Block Assembly
Model: Spirit, Spirit II, Spirit IIE & Spirit EC

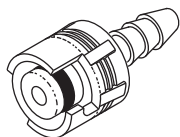

RPI Part #PCC757
OEM Part #94 33 517

MALE QUICK CONNECT (1/8")

- Barb fits 1/8" ID tubing
- Twist to connect
- Coupling rotates freely
- Material: Delrin®
- Mates with In-line Coupling (1/8") (RPI Part #PCC756)

Fits: Foot Control Valve Block Assembly
Models: Spirit, Spirit II, Spirit IIE & Spirit EC

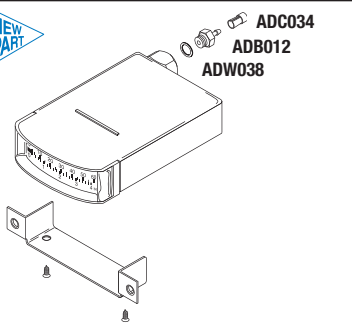

RPI Part #PCG760
OEM Part #30 04 484

PRESSURE GAUGE

- 1-3/4" w x 1/2" h x 2-1/4" lg.
- 0-60 PSI; 0-4 Bar
- Port: #10-32 threaded inlet
- Includes all parts as shown
- **Bracket must be removed for gauge to fit Spirit AC Units**

Fits: Delivery Unit
Models: Spirit AC

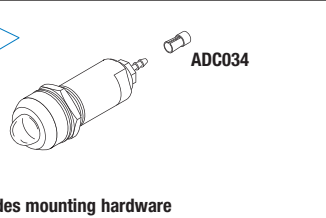

RPI Part #PCL768
OEM Part #30 03 402

AIR INDICATOR (GREEN)

- Nickel plated brass
- Black bezel
- Port: #10-32 threaded inlet with 1/16" barb
- Mounts in 1/2" dia. hole
- Includes all parts as shown

Fits: Delivery Unit
Models: Spirit AC

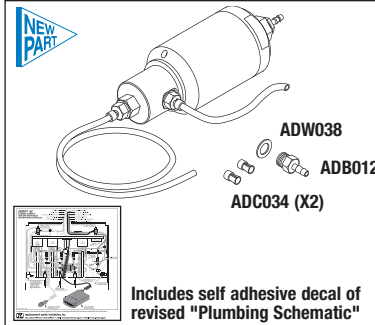

RPI Part #PCK775
OEM Part #51 51 779

ANTI-SIPHON VALVE KIT

- Kit can be used to upgrade from metering valve style to improve water delivery time, or as a replacement for units already upgraded to anti-siphon valve style
- Can also be used as a standard air controlled water valve
- Port: #10-32 threaded inlet with 1/16" barb
- Includes all parts as shown

Fits: Water Delivery Line
Model: Spirit AC (Serial #4839 and below)

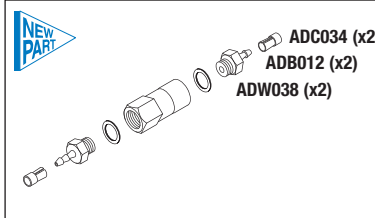

RPI Part #PCV767
OEM Part #18 98 902

CHECK VALVE

- Brass body
- Port: #10-32 threaded inlet with 1/16" barb
- Allows water or air to flow in one direction only
- Includes all parts as shown

Fits: Delivery Unit
Models: Spirit AC



RPI Part #PCV766
OEM Part #15 33 764

VALVE TOGGLE SWITCH

- Replacement for Purge or On/Off Toggle Valve
- Swivels for easy connection to tubing
- Material: Nickel plated brass
- Port: #10-32 threaded inlet with 1/16" barb
- Mounts in 1/2" dia. hole
- Includes all parts as shown

Fits: Delivery Unit
Model: Spirit AC

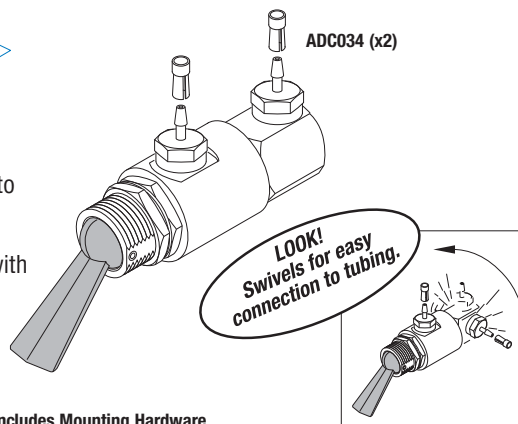

Includes Mounting Hardware

Dental Equipment

Models: Spirit®, Spirit® II, Spirit® IIE, Spirit® AC & Spirit® EC

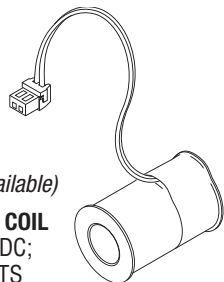

RPI Part #PCC777
OEM Part #
(No OEM Part # Available)

WATER SOLENOID COIL

- Coil Rating: 12VDC; ~44Ω; 3.28WATTS
- Coil: .990" lg. x .620" OD with .363" dia. through hole
- Wire #: 24 AWG; 5-3/8" lg. with JST connector
- Replacement for coil in the Drive Solenoid and Plug Assembly (OEM Part #15 35 371)

Fits: Drive Solenoid and Plug Assembly
Models: Spirit, Spirit II, Spirit IIE & Spirit EC

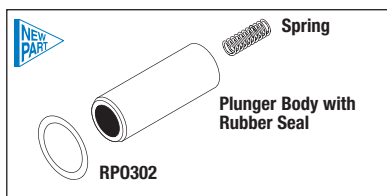

RPI Part #PCK754
OEM Part # *(No OEM Part # Available)*

WATER SOLENOID REPAIR KIT

- Includes all parts as shown
- Fits:** Drive Solenoid and Plug Assembly (OEM Part #15 35 371)
- Models:** Spirit, Spirit II, Spirit IIE & Spirit EC

Use to lube O-rings for easy installation!



RPI Part #RPL090

HIGH TEMP LUBRICANT

- 5 per package
- 1/2 gram per unit
- For non-silicone use only
- Temperature range: -40° to +400°F (-40° to +204°C)
- MSDS and Technical Data Sheet available on RPI website

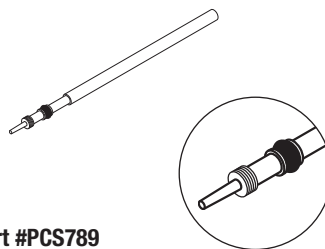

RPI Part #PCS789
OEM Part #020177

WATER VALVE STEM

- 3.13" lg.; Stainless steel
- Includes O-ring (RPI Part #RPO312)
- Fits:** High and Low Speed Handpiece Blocks
- Models:** Spirit, Spirit II, Spirit IIE & Spirit EC

View of Tip

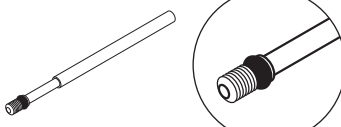

RPI Part #PCS788
OEM Part #021833

AIR VALVE STEM

- 2.56" lg.; Stainless steel
- Includes O-ring (RPI Part #RPO312)
- Uses 3/32" hex key
- Fits:** High and Low Speed Handpiece Blocks
- Models:** Spirit, Spirit II, Spirit IIE & Spirit EC

View of Tip



RPI Part #PCC790
OEM Part #33 02 762

HANDPIECE BLOCK CONNECTOR

- 8 per package
- .365" OD x .365" lg.
- Includes (2) O-rings (RPI Part #RPO305) per connector (installed)
- Brass
- Fits:** High and Low Speed Handpiece Blocks
- Models:** Spirit, Spirit II, Spirit IIE & Spirit EC

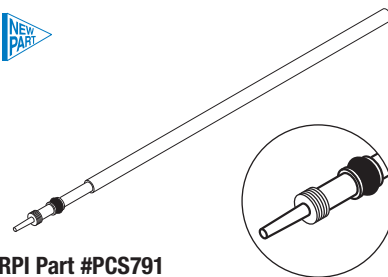

RPI Part #PCS791
OEM Part #94 47 897

WATER VALVE STEM

- 5.60" lg.; Stainless Steel
- Includes O-ring (RPI Part #RPO312)
- Uses 1/8" hex key
- Fits:** Scaler or Electronic Motor Assembly
- Models:** Spirit EC & IIE

View of Tip

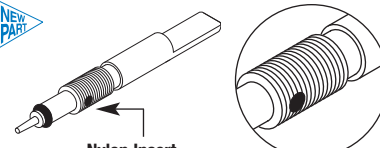

RPI Part #PCV765
OEM Part # *(No OEM Part # Available)*

VALVE STEM

- 1.45" lg.
- Copper with O-ring (RPI Part #RPO310)
- Fits:** Water Adjustment Valve (OEM Part #94 32 774)
- Model:** Spirit AC

View of Nylon Insert



Actual Size

RPI Part #RPO617
OEM Part #70 32 741

O-RING

- 12 per package
- .165" ID x .229" OD x .032" X-Sec
- Material: Buna N
- Duro: 70
- Fits:** Upper Valve Stem of Valve Block Assembly (OEM Part #15 37 443)
- Models:** Spirit AC

Pull-Push Wire, Cable, Tubing, and Fiber Optic Bundles with RPI Plastic & Metal Snakes

It's the RPI Advantage!

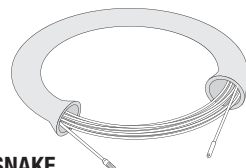

RPI Part #RPT620

PLASTIC TUBING SNAKE

- Metal Snake bends around tight corners for easy work on delivery systems
 - No worries working with the non-conductive Plastic Snake and "J" boxes
 - Easy screw-on tip attachments available for both the Metal and Plastic Snakes
 - Custom designed Fiber-Optic Puller attachment
- For more information, see our website or the General Shop Aids section of the catalog

RPI Part #RPT629

METAL TUBING SNAKE

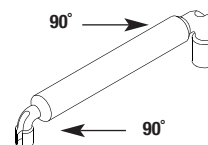
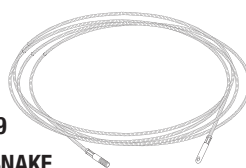

RPI Part #RPT296

UNIVERSAL SLEEVE TOOL

- Use on 1/4" OD tubing and 1/8" OD tubing
- Use to install 1/4" Sleeve clamp (RPI Part #ADC035) and 1/8" Uni-clamp (RPI Part #ADC034)
- The tool provides 90° angles on both ends for ease of use
- ~5" lg.



... Proud to be a **Healthcare Components Group** company ...



**HEALTHCARE
Components Group**

A-DEC

New Parts to fit

A-dec Dental Delivery Units

300 & 500 Series Control Blocks!

RPI Part #ADS279

OEM Part #38.1825.00 (Version 2)

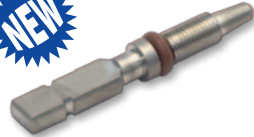

STEM (AIR COOLANT)

- Version 2 design
- Material: Stainless steel
- Double flat stem
- Includes: (1pc) O-Ring (RPI Part #RPO484)
- Also available: Knob (Flow Adj.) (RPI Part #ADK281), High Temp Lubricant (RPI Part #RPL090), and Version 1 Stem (Air Coolant) (RPI Part #ADS234)

Fits: Handpiece Control Block Version 2 (3 and 4 Position) Models: 332, 333, 334, 335, 336 & 541

Models: Stems, Handpiece Control Block 300 Series (38.1871.00), Handpiece Control Block 300 Series (38.1970.00) & Handpiece Control Block 500 Series (38.1972.00)

RPI Part #ADS280

OEM Part #38.1824.00 (Version 2)



STEM (WATER FLOW ADJ.)

- Version 2 design
- Material: Stainless steel
- Double flat stem
- Includes: (1 pc) O-Ring (RPI Part #RPO752)
- Also available: Knob (Flow Adj.) (RPI Part #ADK281), High Temp Lubricant (RPI Part #RPL090), and Version 1 Stem (Water Flow Adj.) (RPI Part #ADS233)

Fits: Handpiece Control Block Version 2 (3 and 4 Position) Models: 332, 333, 334, 335, 336 & 541

Models: Stems, Handpiece Control Block 300 Series (38.1871.00), Handpiece Control Block 300 Series (38.1970.00) & Handpiece Control Block 500 Series (38.1972.00)

RPI Part #ADK281

OEM Part #38.1823.00 (Version 2)



KNOB (FLOW ADJ.)

- Version 2 design
- 5 per package
- Material: Gray polyurethane
- Fits: Double flat stem
- Also available: Stem (Air Coolant) (RPI Part #ADS279) and Stem (Water Flow Adj.) (RPI Part #ADS280)

Fits: Handpiece Control Block Version 2 (3 and 4 Position) Models: 332, 333, 334, 335, 336 & 541

Models: Knobs, Handpiece Control Block 300 Series (38.1871.00), Handpiece Control Block 300 Series (38.1970.00) & Handpiece Control Block 500 Series (38.1972.00)



RPI Part #ADR283

OEM Part #38.1800.01

BARB RETAINER

- Version 1 (3 Position) and Version 2 (3 Position) compatible
- Material: White delrin

Fits: Handpiece Control Block Version 1 and 2 (3 Position) Models: 332, 333, 334, 335, and 336

Models: Barbs and Barb Kits, Handpiece Control Block 300 Series (38.1831.00), Handpiece Control Block 300 Series (38.1871.00)



RPI Part #ADD282

OEM Part #38.1833.01

DIAPHRAGM (3 POSITION)

- Version 1 (3 Position) and Version 2 (3 Position) compatible
- 5 per package
- Material: Fairprene

Fits: Handpiece Control Block Version 1 and 2 (3 Position) Models: 332, 333, 334, 335, and 336

Models: Diaphragms, Handpiece Control Block 300 Series (38.1831.00), Handpiece Control Block 300 Series (38.1871.00)

Don't Forget ...

RPI's offers other parts to fit A-dec 300 & 500 Handpiece Control Blocks including:

- Barb Retainer (4 Position)
- Diaphragm (4 Position)
- Control Block Kit (Major)
- Control Block Kit (Minor)
- Helical Compression Springs
- Many more!



replacement parts industries, inc. A Healthcare Components Group Company

CALL (800) 221-9723 • FAX (818) 882-7028 • EMAIL order@ripiparts.com • WEBSITE www.ripiparts.com

The above parts are manufactured by Replacement Parts Industries, Inc. to fit the equipment noted. All product names used in this document are trademarks or registered trademarks of their respective holders. 2003AD RD1 Show 11/22

SECTION

4

PAGE

554

UPDATED

11/22

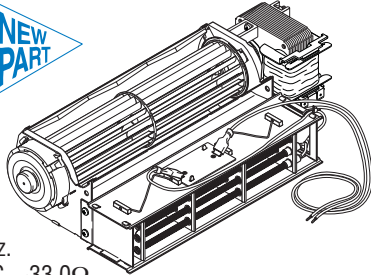

**RPI Part #ATA670
OEM Part #43330**

HEATER & FAN ASSY.

- Fan: 120VAC, 50/60 Hz.
- Heater: 360W, 120VAC, ~33.0Ω
- Includes FAN (RPI Part #ATF667), Heater Element (RPI Part #ATH668) & Overheat Thermostat (RPI Part #ATT669)
- Does not include the plastic mounting plate. If possible, use the existing mounting plate for installation.

Fits: Cover Assembly

Models: A/T2000, A/T2000 PLUS & A/T2000 XR

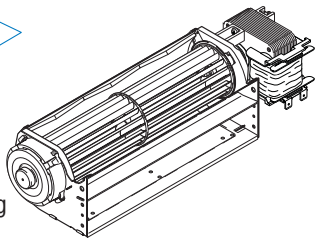

**RPI Part #ATF667
OEM Part #43530**

FAN

- 120VAC, 50/60 Hz.
- 2.77" W x 3.11" D x 10.43" Lg
- 1/4" tabs

• Also included in Heater and Fan Assembly (RPI Part #ATA670)

Fits: Heater and Fan Assembly

Models: A/T2000, A/T2000 PLUS & A/T2000 XR

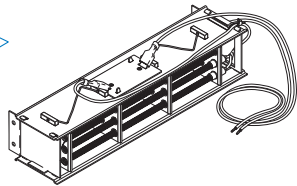

**RPI Part #ATH668
OEM Part #43811**

HEATER ELEMENT

- 360W, 120VAC, ~33.0Ω
- 1.61" T x 1.69" D x 7.64" Lg
- Includes Overheat Thermostat (RPI Part #ATT669)
- Also included in Heater and Fan Assembly (RPI Part #ATA670)

Fits: Heater and Fan Assembly

Models: A/T2000, A/T2000 PLUS & A/T2000 XR

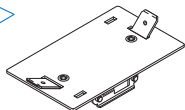

RPI Part #ATT669

OEM Part # (No OEM Part # Available)

OVERHEAT THERMOSTAT

- Factory set at 60° C
- 1/4" tabs
- Can only be used with Heater Element (RPI Part #ATH668) and Heater and Fan Assembly (RPI Part #ATA670)
- RPI Advantage! RPI's Thermostat is replaceable unlike the OEM's Thermostat

Fits: Heater Element

Models: A/T2000, A/T2000 PLUS & A/T2000 XR

**RPI Part #ATH639
OEM Part #43290**

HEATER BAR ASSEMBLY

- 115V, 100W, 130Ω
- 5kΩ Thermistors @ 25°C
- Includes (2) O-Rings (RPI Part #RPO244)

Fits: Base Assembly

Models: A/T2000 & A/T2000 PLUS

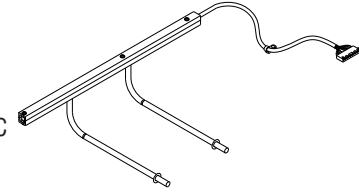

RPI Part #RPO244

OEM Part #43362

INDUSTRY PART #568-203

O-RING

- 6 per package
- Material: Silicone; Color: Red

Fits: Heater Bar Assembly

Models: A/T2000 & A/T2000 PLUS

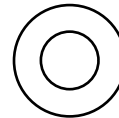

Actual Size

**RPI Part #ATA644
OEM Part #43224-1**

REMOTE SOLENOID WATER VALVE ASSEMBLY

- 115VAC: 60Hz

Fits: Incoming water line to processor base

Models: A/T2000 & A/T2000 PLUS

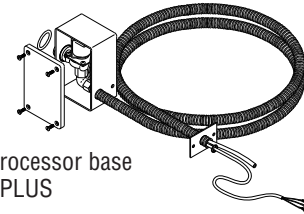

RPI Part #ATV645

OEM Part # (No OEM Part # Available)

SOLENOID VALVE ASSEMBLY

- 115VAC: 60Hz

Fits: Remote Solenoid Water Valve Assembly

Models: A/T2000 & A/T2000 PLUS

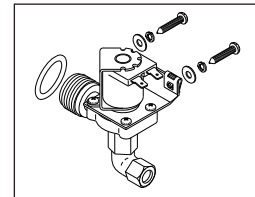

**RPI Part #ATS641
OEM Part #43447**

WATER LEVEL SENSOR

Fits: Base Assembly

Models: A/T2000 & A/T2000 PLUS

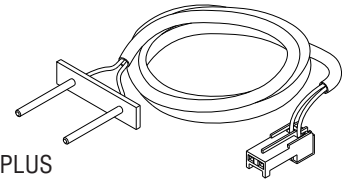

This PC Board is HumiSeal® Conformal Coated!

**RPI Part #ATB643
OEM Part #43420**

BASE PC BOARD

- 115VAC: 60Hz

Fits: Base Assembly

Models: A/T2000 only

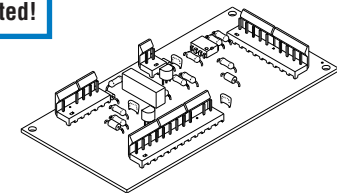

This PC Board is HumiSeal® Conformal Coated!

**RPI Part #ATK646
OEM Part #43942**

DRIVE MOTOR BOARD WITH HARNESS

- 115 VAC
- Includes: Speed Control PC Board, Butt Connector (RPI Part #RPT011), Wrench, Cable Tie 8" (RPI Part #RPT278), and (2) Cable Tie 4" (RPI Part #RPT083)

Fits: Motor Block Assembly

Models: A/T2000 only

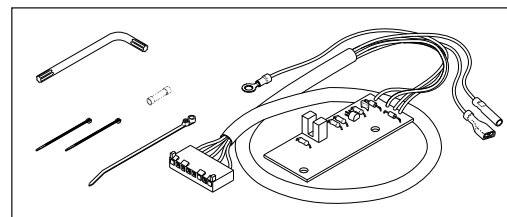

Dental Equipment

Model: A/T2000, A/T2000 PLUS & A/T2000 XR (continued)

NOTES: _____

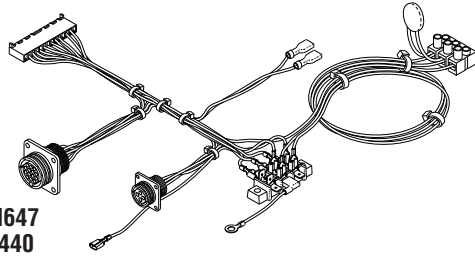

RPI Part #ATH647
OEM Part #43440

BASE WIRING HARNESS
Fits: Base Assembly
Models: A/T2000 only

RPI Part #RPH638
OEM Part #90219

FUSE HOLDER (MAIN)
 • 20A @ 250VAC
 • 3/16" quick connect tab
 • Accomodates standard 1/4" x 1-1/4" fuse
 • Fits .50" dia. mounting hole
 • Includes mounting hardware
Fits: Back Panel
Models: A/T2000, A/T2000 PLUS & A/T2000 XR

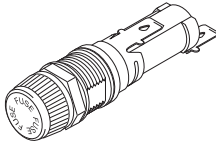

RPI Part #RPF552
OEM Part #41914

FUSE (8A, 250V) - TIME DELAY
 • 5 per package
 • Type: Ceramic
 • Size: 1/4" dia. x 1-1/4" lg.
Fits: Fuse Holder
Models: A/T2000, A/T2000 PLUS & A/T2000 XR

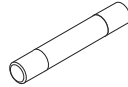

RPI Part #RPF362
OEM Part #43106

LEVELER LEG
 • 4 per package
 • 1/4-20 x 1-1/2" lg. stem
 • Nylon base with 7/8" hex
 for ease of adjustment
Fits: Leveling Base
Models: A/T2000, A/T2000 PLUS & A/T2000 XR

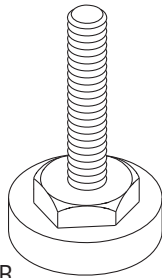

RPI Part #ATS642
OEM Part #30552

THUMB SCREW
 • 8 per package
 • 6-32 x 3/8
 • Nylon® 66
Fits: Molded Base/Fixer & Developer Circulator Cover
Models: A/T2000 & A/T2000 PLUS

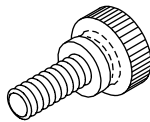

RPI Part #ATW638
OEM Part #43271

DRAIN TUBE WASHER
 • 6 per package
 • Material: EPDM
Fits: Drain Tube
Models: A/T2000, A/T2000 PLUS & A/T2000 XR

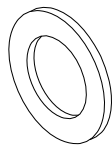

**PERI-PRO (90000),
PERI-PRO II (91000)
& PERI-PRO III (94000)**

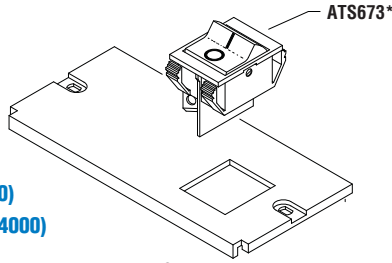

*Peri-Pro S/N #15000 and above & Peri-Pro II S/N #15143 and above

PERI-PRO II (91000)

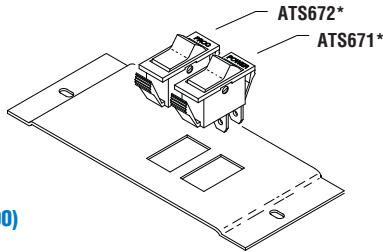

*Peri-Pro II S/N #15142 and below

**PERI-PRO II (91000)
& PERI-PRO III (94000)**

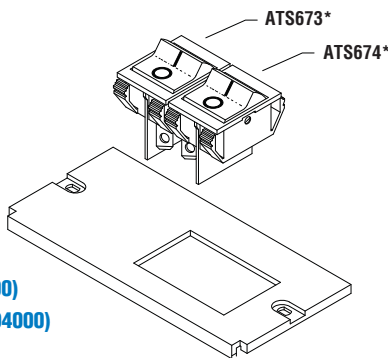

*Peri-Pro II S/N #15143 and above

**SWITCHES TO FIT
PERI-PRO (90000), PERI-PRO II (91000)
& PERI-PRO III (94000)**

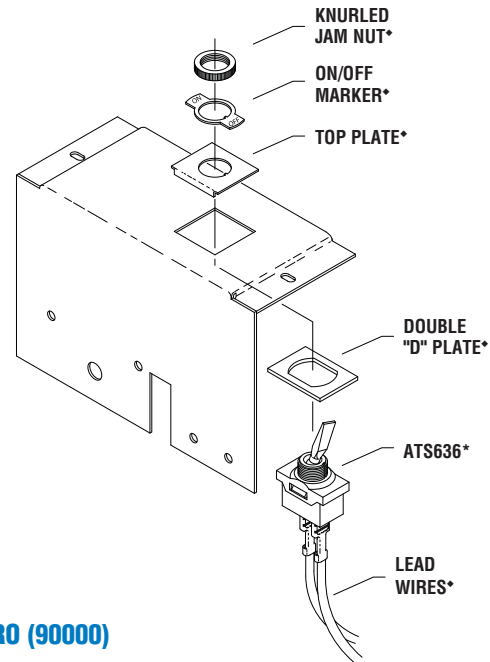

PERI-PRO (90000)

*Peri-Pro S/N #14999 and below

*Included in Power Switch Assembly (RPI Part #ATS636)

RPI PART #	OEM PART #	DESCRIPTION	PKG QTY	PERI-PRO			NOTES
				I	II	III	
ATS636	90221	POWER SWITCH ASSEMBLY	1	1			<ul style="list-style-type: none"> • Black toggle • SPST • 10A@250VAC; 20A@125VAC • Includes mounting hardware (see Footnote * above)
ATS671	116521	PROCESS SWITCH	1		2		<ul style="list-style-type: none"> • Panel cutout: .483" x 1.075" • SPST (on/off) rocker switch; 1/4" tabs • 16A@125/250VAC • Color: white body • Legend: "PROC" marked on bezel
ATS672	116520	POWER SWITCH	1		2		<ul style="list-style-type: none"> • Panel cutout: .483" x 1.075" • SPST (on/off) rocker switch; 1/4" tabs • 16A@125/250VAC • Color: white body • Legend: "POWER" marked on bezel
ATS673	94269 (Black)	POWER SWITCH (AMBER) <i>Note: Regarding the Peri-Pro II only - This black Power Switch (Black) replaces the OEM white Power Switch (OEM Part #90262).</i>	1	3	4	•	<ul style="list-style-type: none"> • Panel cutout: .880 x 1.080" • SPST (on/off) rocker switch; 1/4" tabs • 20A@125VAC • Color: illuminated amber lens; black body • Legend: I/O
ATS674	94977 (New) 94266 (Old)	PROCESS SWITCH (GREEN)	1		4	•	<ul style="list-style-type: none"> • Panel cutout: .880 x 1.080" • SPST (on/off) rocker switch; 1/4" tabs • 20A@125VAC; 28V lamp indicator • Color: illuminated green lens; black body • Legend: I/O

1 = Peri-Pro Serial #14999 and below
3 = Peri-Pro Serial #15000 and above

2 = Peri-Pro II Serial #15142 and below
4 = Peri-Pro II Serial #15143 and above

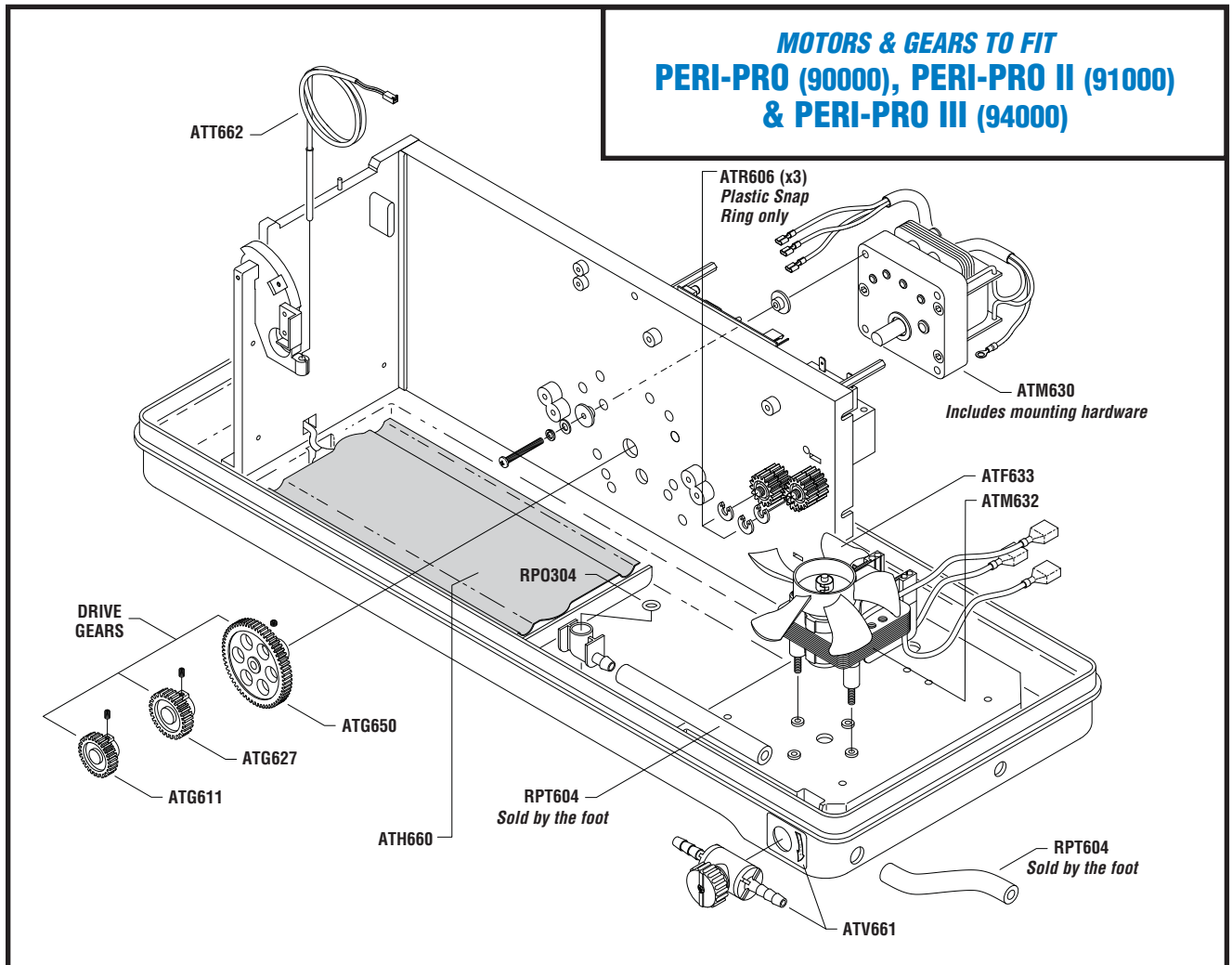

RPI PART #	OEM PART #	DESCRIPTION	PKG QTY	PERI-PRO			NOTES
				I	II	III	
ATG611	90995	MAIN DRIVE GEAR	1	•			<ul style="list-style-type: none"> • 30 teeth; .312" ID x 1.34" OD • Fits: Main Drive Motor
ATG627	90996	MAIN DRIVE GEAR	1		•		<ul style="list-style-type: none"> • 36 teeth; .312" ID x 1.57" OD • Fits: Main Drive Motor
ATG650	94995	MAIN DRIVE GEAR	1			•	<ul style="list-style-type: none"> • 66 teeth; .312" ID x 2.82" OD • Fits: Main Drive Motor
ATH660	94970	HEATER PLATE	1			•	<ul style="list-style-type: none"> • 40W, 24VDC; Thermal cutout opens at 112°F
ATM630	90147	MAIN DRIVE MOTOR	1	•	•	•	<ul style="list-style-type: none"> • 115VAC, 60 Hz. • Includes mounting hardware
ATM632	90880	DRYER FAN & MOTOR ASSEMBLY	1	•	•	•	<ul style="list-style-type: none"> • 115VAC, 60 Hz. • Includes Fan Blade (RPI Part #ATF633) • Includes mounting hardware
ATF633	90102	DRYER FAN BLADE	1	•	•	•	<ul style="list-style-type: none"> • Plastic • Mounts on 3/16" dia. motor shaft • Fits: Fan Motor Assembly
ATT662	94975	THERMISTOR PROBE	1			•	<ul style="list-style-type: none"> • Rated: 5000Ω at 25°C
ATV661	94994	DRAIN VALVE	1			•	<ul style="list-style-type: none"> • Includes valve handle, mounting hardware and decal • 1/4" hose barb
RPO304	60604	O-RING	12			•	<ul style="list-style-type: none"> • .301" ID x .441" OD x .070" C/S
RPT604	94124	DRAIN TUBING	Sold by the foot			•	<ul style="list-style-type: none"> • 1/4" ID x 3/8" OD • Material: clear flexible PVC • Fits: Drain Valve (RPI Part #ATV661)

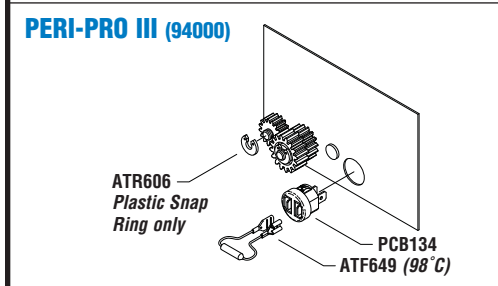
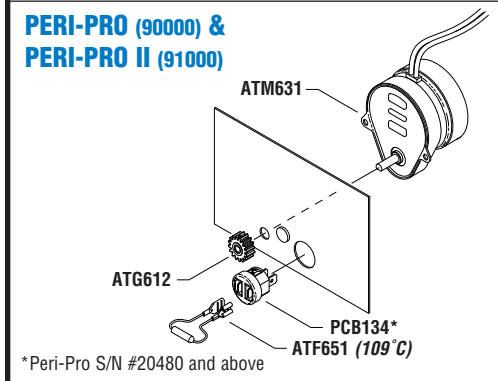
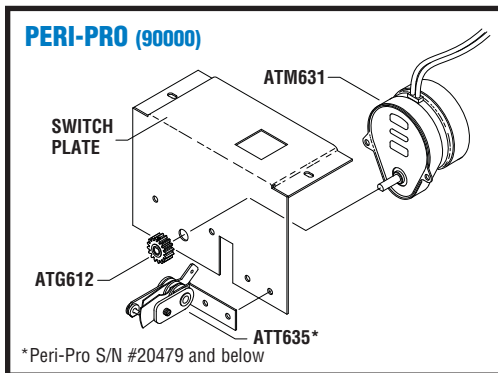

**HEATER & FUSES TO FIT
PERI-PRO (90000), PERI-PRO II (91000)
& PERI-PRO III (94000)**

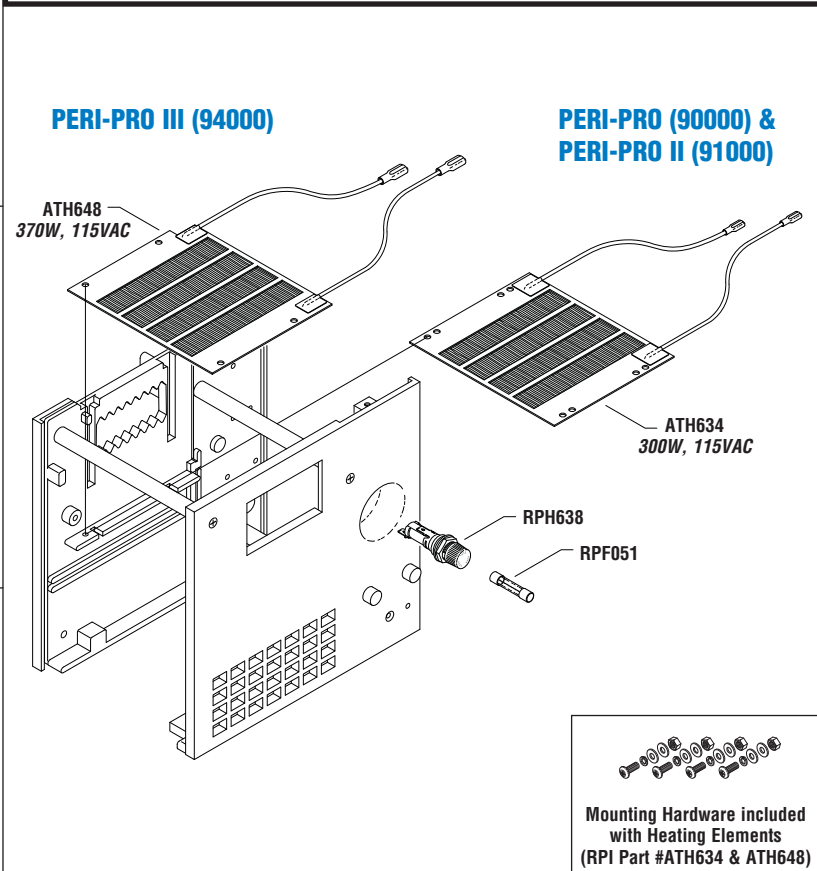

RPI PART #	OEM PART #	DESCRIPTION	PKG QTY	PERI-PRO			NOTES
				I	II	III	
ATF649	94278	THERMAL FUSE (98°C) (Only fits Peri-Pro III)	1			•	• Opens at temperature of 98°C • Fits: Terminal Bushing (RPI Part #PCB134)
ATF651	90278	THERMAL FUSE (109°C) (Only fits Peri-Pro I & II)	1	•	•		• Opens at temperature of 109°C • Fits: Terminal Bushing (RPI Part #PCB134)
ATG612	91993	DRYER DRIVE GEAR	1	•	•		• 16 teeth; .188" ID x .75" OD • Fits: Dryer Drive Motor
ATH634	90610	HEATING ELEMENT (DRYER)	1	•	•		• 300W; 115VAC; ~43.8Ω • Use with Thermal Fuse (RPI Part #ATF651) • Includes mounting hardware
ATH648	94630	HEATING ELEMENT (DRYER)	1			•	• 370W; 115VAC; ~35.5Ω • Use with Thermal Fuse (RPI Part #ATF649) • Includes mounting hardware
ATM631	90223	DRYER DRIVE MOTOR	1	•	•		• 115VAC, 60 Hz.
ATT635	90210	THERMOSTAT/BRACKET ASSEMBLY	1	1			• Opens at 165°F
PCB134	117327	ELECTRICAL TERMINAL BUSHING	1	2	•	•	• 3 per package • Mounts Thermal Fuse
RPF051	90265	FUSE (5A, 250VAC)	5	•	•	•	• Type: Glass; AGC Fast Acting • Size: 1/4" dia. x 1-1/4" lg.
RPH638	90219	FUSE HOLDER (MAIN)	1	•	•	•	• 3/16" quick connect tab • Accomodates standard 1/4" x 1-1/4" fuse • 20A@250VAC • Fits .50" dia. mounting hole • Includes mounting hardware

1 = Peri-Pro Serial #20479 and below

2 = Peri-Pro Serial #20480 and above

Call Us Toll-Free Monday-Friday, 8:00 AM-4:30 PM (Pacific Time), (800) 221-9723



Dental Equipment

Models: Peri-Pro® (90000), Peri-Pro II® (91000) & Peri-Pro III® (94000) (continued)

EXPLODED VIEW OF PERI-PRO (90000) & PERI-PRO II (91000)

UPDATED

RPI Has Expanded the Shutter Release Repair Kit & Transport Repair Kit to include MORE parts!

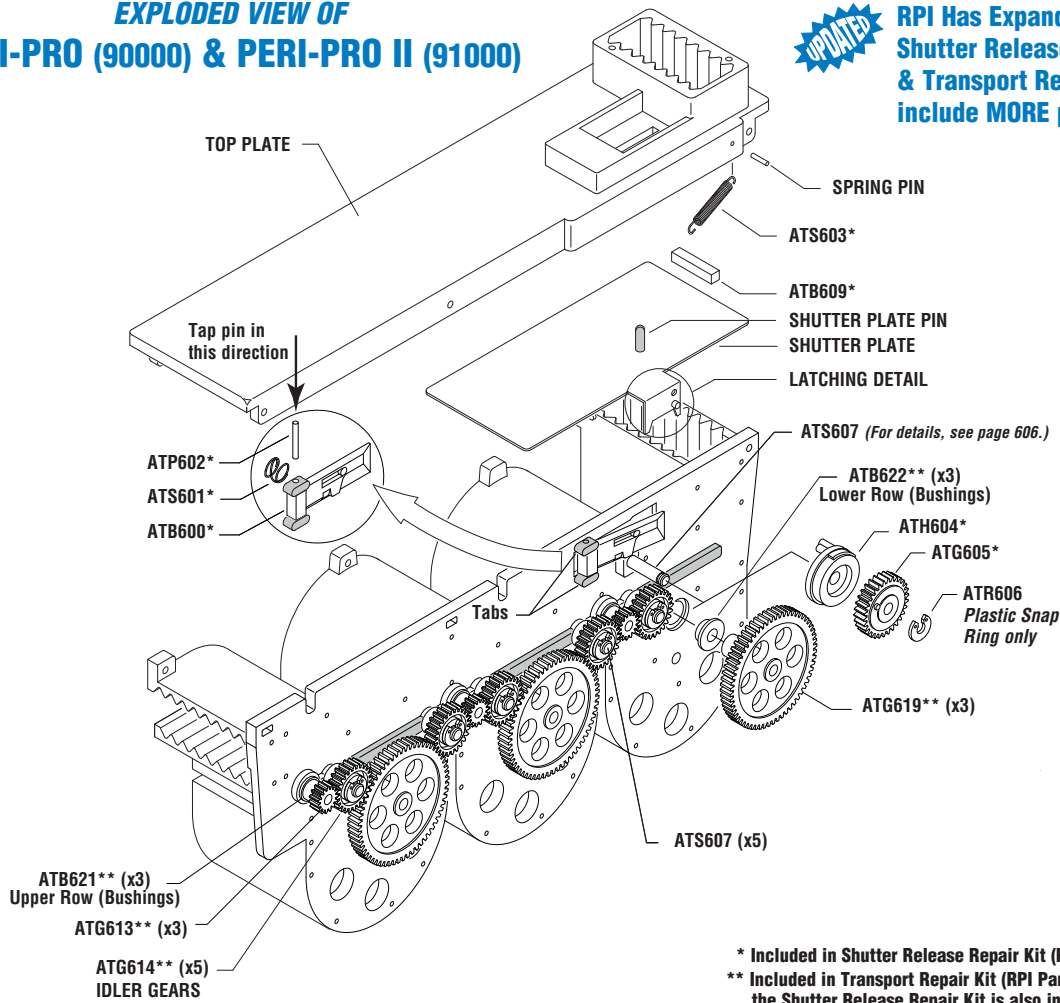

RPI PART #	OEM PART #	DESCRIPTION	KIT QTY	Reorder PKG QTY	PERI-PRO		NOTES
					I	II	
ATK629	90988	TRANSPORT REPAIR KIT		1	•	•	UPDATED Now includes all parts listed below
ATB616	90522	TRANSFER ARM BEARING	3	3	•	•	Fits: Transfer Arm Assemblies
ATB621	90523	"L" TRANSFER ARM BUSHING	6	6	•	•	Fits: Upper rows; .188" dia. shaft
ATB622	90524	TRANSFER ARM BUSHING	6	6	•	•	Fits: Lower rows; .250" shaft UPDATED Now includes 6 per package
ATG613	90525	"L" TRANSFER ARM GEAR	3	3	•	•	15 teeth; .171" ID x .70" OD
ATG614	90519	IDLER GEAR	5	5	•	•	24 teeth; .250" ID x 1.08" OD UPDATED Now includes 5 per package
ATG615	90518	TRANSFER ARM GEAR	3	3	•	•	24 teeth; .250" ID x 1.08" OD
ATG619	90517	TRANSFER ARM GEAR	3	1	•	•	60 teeth; .250" ID x 2.57" OD
ATG620	90516	TRANSFER GEAR	3	3	•	•	24 teeth; .250" ID x 1.08" OD
ATK628	(No OEM Part # Available)	SHUTTER RELEASE REPAIR KIT	1	1	•	•	See below for all parts included in this Kit
ATR606	90543	PLASTIC SNAP RING	10	10	•	•	
ATK628	(No OEM Part # Available)	SHUTTER RELEASE REPAIR KIT		1	•	•	UPDATED Now includes all parts listed below
ATB600	90548	SHUTTER RELEASE BAR	1	1	•	•	New Steel Stopper Pin for better performance
ATB609	90546	RUBBER BUMPER	1	6	•	•	Use Silicone Gasket Maker 598 (RPI Part#RPS639)
ATG605	90521	TIMER GEAR	1	1	•	•	30 teeth; .250" ID x 1.34" OD
ATH604	90540	HUB & PIN ASSEMBLY	1	1	•	•	Includes hub, and (2) stainless steel pins
ATP602	30391	SPRING PIN	1	6	•	•	Stainless steel; .093" OD x .937" lg.
ATR606	90543	PLASTIC SNAP RING	1	10	•	•	UPDATED Now includes 10 per package
ATS601	90545	COMPRESSION SPRING	1	6	•	•	Stainless steel; .375" OD x .250" lg. x .026" wire
ATS603	90512	SHUTTER RETURN SPRING	1	3	•	•	Stainless steel; .190" OD x 1.620" lg. x .020" wire

FAX: (818) 882-7028 • E-MAIL: order@rpiarts.com • WEBSITE: www.rpiarts.com

EXPLODED VIEW OF PERI-PRO (90000) & PERI-PRO II (91000)

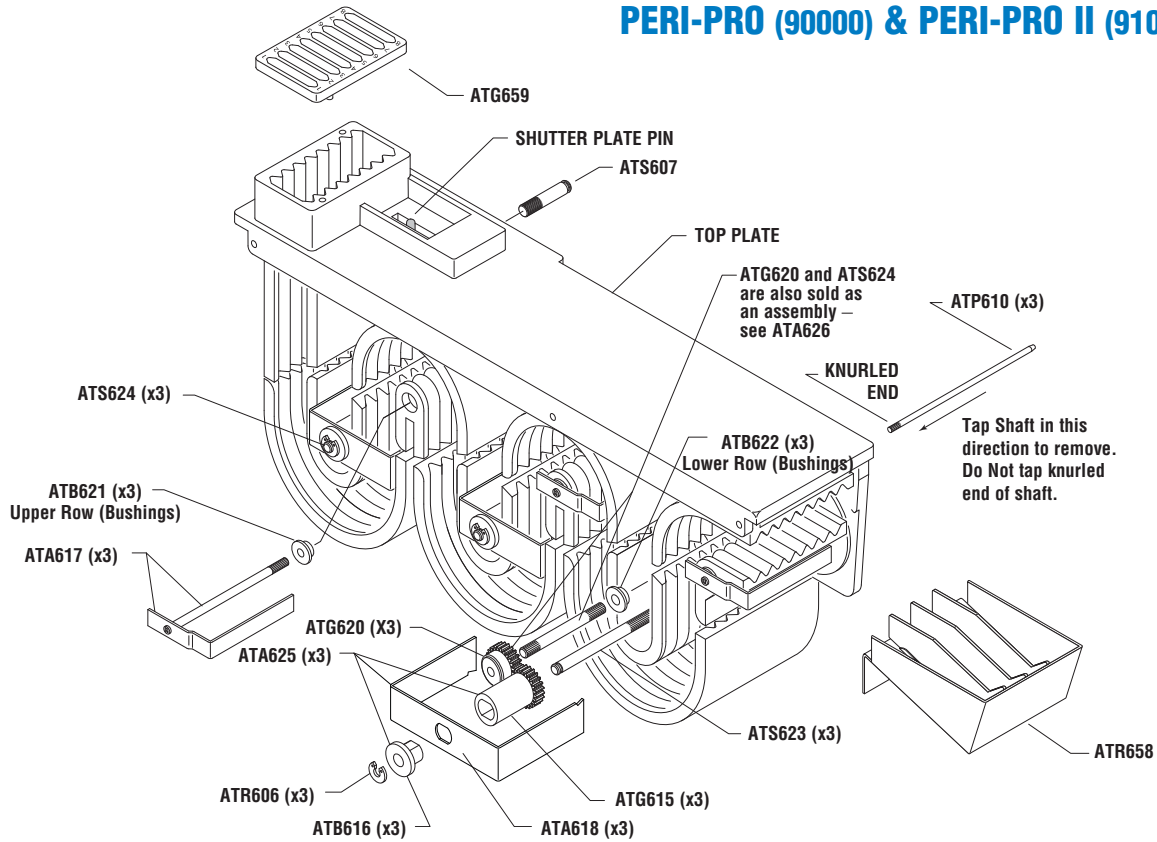

* Included in Shutter Release Repair Kit (RPI Part #ATK628)

** Included in Transport Repair Kit (RPI Part #ATK629)

RPI PART #	OEM PART #	DESCRIPTION	PKG QTY	PERI-PRO		NOTES
				I	II	
ATA617	90520	"L" TRANSFER ARM ASSEMBLY	1	•	•	Fits: Transport Assembly
ATA618	90564	"U" TRANSFER ARM	1	•	•	Fits: "U" Transfer Arm Assy (RPI Part #ATA625)
ATA625	90530	"U" TRANSFER ARM ASSEMBLY	1	•	•	Includes "U" Transfer Arm (RPI Part #ATA618), Transfer Gear (RPI Part #ATG615) and Transfer Arm Bearing (RPI Part #ATB616)
ATG659	90555	FILM INLET GRILLE	1	•	•	
ATP610	90505	TOP PLATE PIN	1	•	•	Stainless Steel; .125" OD x 3.562" lg. (Sold Individually; Transport requires 3)
ATR658	90810	FILM RECEPTACLE	1	•	•	Fits: Outer Cover
ATS623	90504	TRANSFER ARM SHAFT	1	•	•	Stainless Steel; .250" OD x 3.234" lg.
ATS607	90502	IDLER GEAR SHAFT	1	•	•	Stainless Steel; .250" OD x 1.085" lg.
ATA626	90550	"U" TRANSFER DRIVE ASSEMBLY		•	•	Includes all parts listed below
ATS624	90506	TRANSFER DRIVE SHAFT	1	•	•	Stainless Steel; .250" OD x 2.463" lg.
ATG620	90516	TRANSFER GEAR	1*	•	•	24 teeth; .250" ID. X 1.08" OD

* RPI Part #ATG620 is also sold separately as a package quantity of 3 pieces.

NOTES: _____

Dental Equipment

Models: Peri-Pro[®] (90000), Peri-Pro II[®] (91000) & Peri-Pro III[®] (94000) (continued)

EXPLODED VIEW OF PERI-PRO III (94000)



NOW AVAILABLE!
Shutter Release Repair Kit
& Transport Repair Kit!

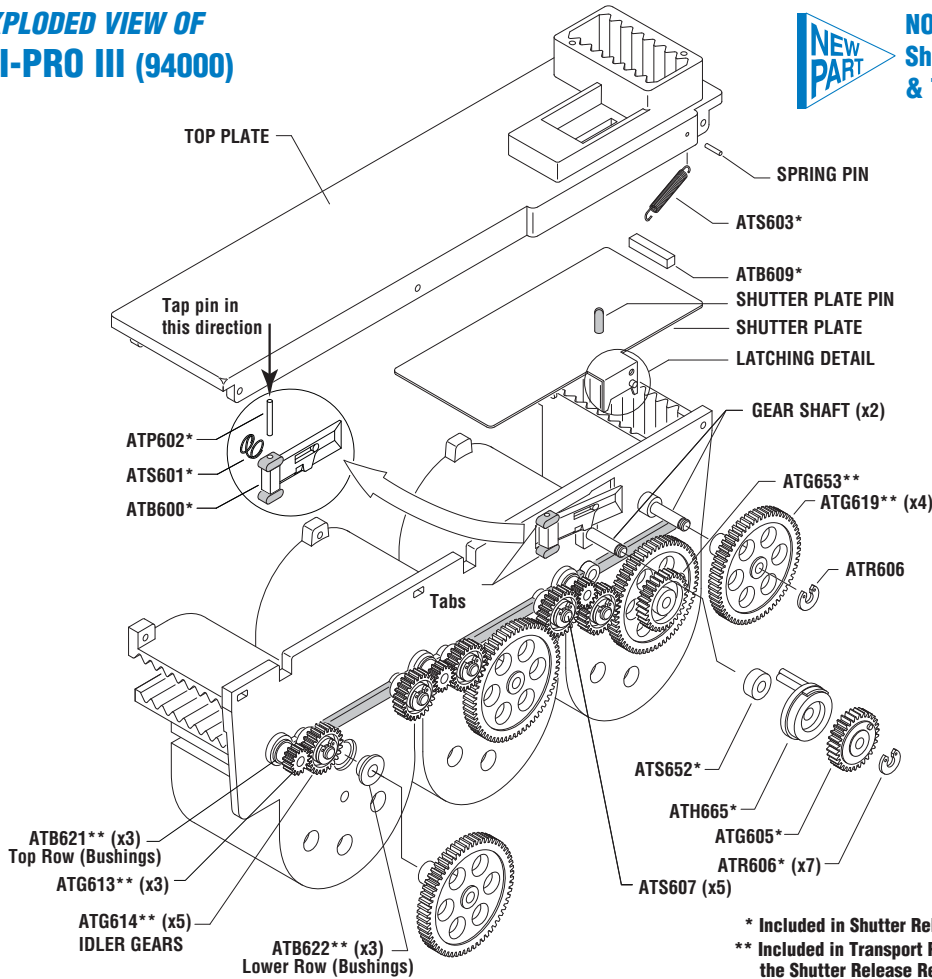

* Included in Shutter Release Repair Kit (RPI Part #ATK664)
** Included in Transport Repair Kit (RPI Part #ATK663) PLUS
the Shutter Release Repair Kit is also include in this Kit!

RPI PART #	OEM PART #	DESCRIPTION	KIT QTY	Reorder PKG QTY	PERI-PRO III	NOTES
ATK663	94988	TRANSPORT REPAIR KIT		1	•	<i>Includes all parts listed below</i>
ATB616	90522	TRANSFER ARM BEARING	3	3	•	Fits: Transfer Arm Assemblies
ATB621	90523	"L" TRANSFER ARM BUSHING	6	6	•	Fits: Upper rows; .188" dia. shaft
ATB622	90524	TRANSFER ARM BUSHING	6	6	•	Fits: Lower rows; .250" shaft Now includes 6 per package
ATG613	90525	"L" TRANSFER ARM GEAR	3	3	•	15 teeth; .171" ID x .70" OD
ATG614	90519	IDLER GEAR	5	5	•	24 teeth; .250" ID x 1.08" OD Now includes 5 per package
ATG615	90518	TRANSFER ARM GEAR	3	3	•	24 teeth; .250" ID x 1.08" OD
ATG619	90517	TRANSFER ARM GEAR	4	1	•	60 teeth; .250" ID x 2.57" OD
ATG620	90516	TRANSFER GEAR	3	3	•	24 teeth; .250" ID x 1.08" OD
ATG653	94501	SPEED REDUCER GEAR	1	1	•	30 teeth
ATK664	(No OEM Part # Available)	SHUTTER RELEASE REPAIR KIT	1	1	•	<i>See below for all parts included in this Kit</i>
ATR606	90543	PLASTIC SNAP RING	10	10	•	
ATK664	(No OEM Part # Available)	SHUTTER RELEASE REPAIR KIT		1	•	<i>Includes all parts listed below</i>
ATB600	90548	SHUTTER RELEASE BAR	1	1	•	New Steel Stopper Pin for better performance
ATB609	90546	RUBBER BUMPER	1	6	•	Use Silicone Gasket Maker 598 (RPI Part#RPS639)
ATG605	90521	TIMER GEAR	1	1	•	30 teeth; .250" ID x 1.34" OD
ATH665	94540	HUB & PIN ASSEMBLY	1	1	•	Includes hub, and (2) stainless steel pins
ATP602	30391	SPRING PIN	1	6	•	Stainless steel; .093" OD x .937" lg.
ATR606	90543	PLASTIC SNAP RING	1	10	•	Now includes 10 per package
ATS601	90545	COMPRESSION SPRING	1	6	•	Stainless steel; .375" OD x .250" lg. x .026" wire
ATS603	90512	SHUTTER RETURN SPRING	1	3	•	Stainless steel; .190" OD x 1.620" lg. x .020" wire
ATS652	(No OEM Part # Available)	SPACER	1	3	•	Nylon [®] ; .260" ID x .500" OD x .250" Thk

FAX: (818) 882-7028 • E-MAIL: order@rpiparts.com • WEBSITE: www.rpiparts.com

EXPLODED VIEW OF PERI-PRO III (94000)

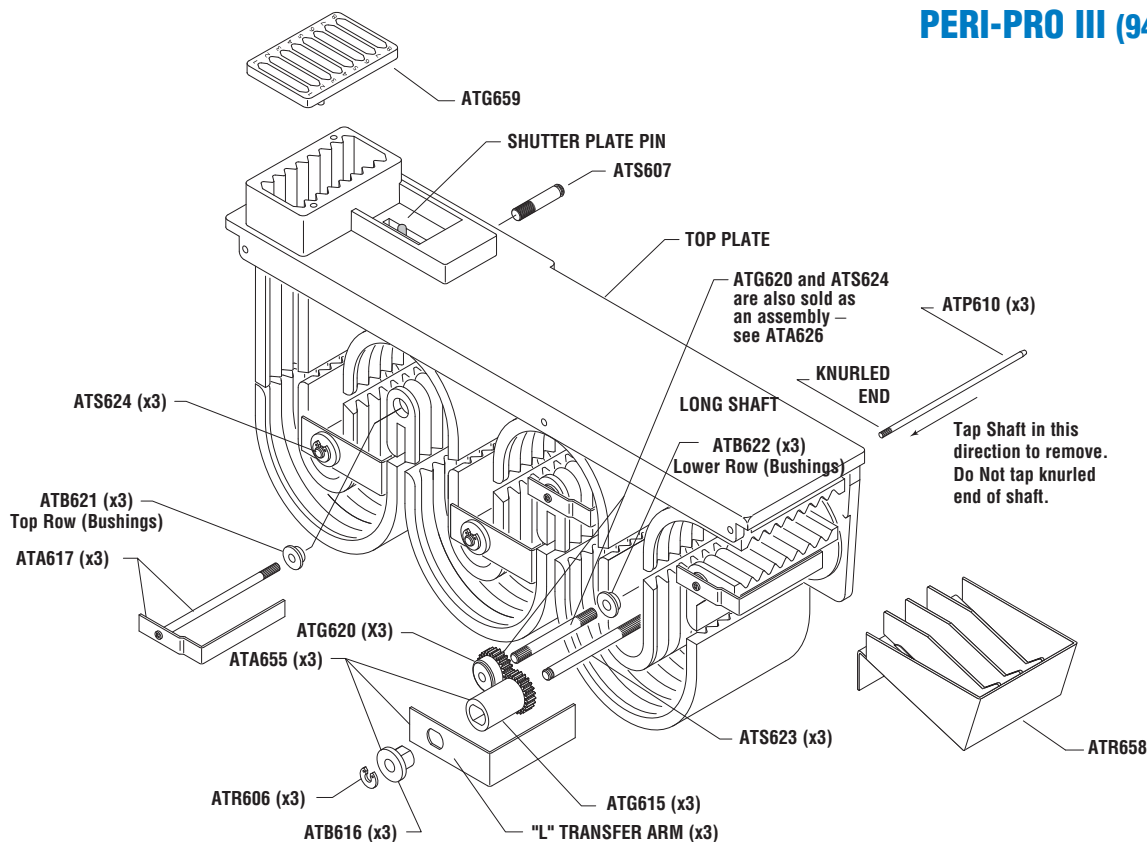

* Included in Shutter Release Repair Kit (RPI Part #ATK664)

** Included in Transport Repair Kit (RPI Part #ATK663)

RPI PART #	OEM PART #	DESCRIPTION	PKG QTY	PERI-PRO III	NOTES
ATA617	90520	"L" TRANSFER ARM ASSEMBLY	1	•	Fits: Transport Assembly
ATA655	94530	"L" TRANSFER ARM ASSEMBLY	1	•	Includes "L" Transfer Arm, Transfer Gear (RPI Part #ATG615) and Transfer Arm Bearing (RPI Part #ATB616)
ATG659	90555	FILM INLET GRILLE	1	•	
ATP610	90505	TOP PLATE PIN	1	•	Stainless Steel; .125" OD x 3.562" lg. (Sold Individually; Transport requires 3)
ATR658	90810	FILM RECEPTACLE	1	•	Fits: Outer Cover
ATS623	90504	TRANSFER ARM SHAFT	1	•	Stainless Steel; .250" OD x 3.234" lg.
ATS607	90502	IDLER GEAR SHAFT	1	•	Stainless Steel; .250" OD x 1.085" lg.
ATA626	90550	"U" TRANSFER DRIVE ASSEMBLY	1	•	Includes all parts listed below
ATS624	90506	TRANSFER DRIVE SHAFT	1	•	Stainless Steel; .250" OD x 2.463" lg.
ATG620	90516	TRANSFER GEAR	1*	•	24 teeth; .250" ID. X 1.08" OD

* RPI Part #ATG620 is also sold separately as a package quantity of 3 pieces.

NOTES:

RPI Part #PHP016
OEM Part #874-026393

SHORT DOUBLE KNURL PIN

- 5 per package
- Stainless steel
- 3/16" Dia. x 1-1/16" Lg.

Fits: Short Pin Plastic Roller (Developer, Fixer and Washer/Dryer Transport Module)
Models: 810 & 9000



RPI Part #PHP017
OEM Part #874-026883

LONG DOUBLE KNURL PIN

- 5 per package
- Stainless steel
- 3/16" Dia. x 1-1/2" Lg.

Fits: Long Pin Plastic Roller (Developer, Fixer and Washer/Dryer Transport Module)
Models: 810 & 9000



RPI Part #PHP018
OEM Part #874-026754

SHORT MIDDLE KNURL PIN

- 5 per package
- Stainless steel
- 3/16" Dia. x 1-1/16" Lg.

Fits: Short Pin Plastic Roller, Long Pin Plastic Roller, Ingress Plastic Roller, and Ingress Plastic Roller Assembly (Developer, Fixer and Washer/Dryer Transport Module)
Models: 810 & 9000



RPI Part #PHP019
OEM Part # N/A

LARGE KNURL PIN

- 5 per package
- Stainless steel
- 1/4" Dia. x 1-5/16" Lg.

Fits: Large Knurl Pin, Ingress Drive Shaft Assembly, Gear with Drilled Shaft, and Ingress Plastic Roller Assembly Developer, Fixer and Washer/Dryer Transport Module)
Models: 810 & 9000



ROLLER COMPONENTS CHART

	#1 Rubber Roller Assembly with Clip RPI Part #PHR001 OEM Part #874-00007	#2 Rubber Roller Assembly with Clip RPI Part #PHR002 OEM Part #874-01007	#3 Rubber Roller Assembly with Clip RPI Part #PHR003 OEM Part #874-02007	Short Pin Plastic Roller RPI Part #PHR004 OEM Part #874-00007	Long Pin Plastic Roller RPI Part #PHR006 OEM Part #874-00007	Ingress Plastic Roller Assembly RPI Part #PHR005 OEM Part # N/A	Ingress Plastic Roller Assembly RPI Part #PHR025 OEM Part #874-00007
Short Double Knurl Pin RPI Part #PHP016 OEM Part #874-026393				●			
Long Double Knurl Pin RPI Part #PHP017 OEM Part #874-026883					●		
Short Middle Knurl Pin RPI Part #PHP018 OEM Part #874-026754			●	●	●	●	
Large Knurl Pin RPI Part #PHP019 OEM Part # N/A				●			
Ingress Drive Shaft Assembly RPI Part #PHA022 OEM Part #866-02207						●	
Retaining Clip RPI Part #PHC015 OEM Part #875-033007	●	●					

RPI Part #PHC015
OEM Part #875-033007

RETAINING CLIP

- 5 per package
- Stainless steel
- 1/4" ID

Fits: #1 and #2 Rubber Roller Assembly (Developer, Fixer and Washer/Dryer Transport Module)
Models: 810 & 9000



RPI Part #PHS024
OEM Part #800-045461

IDLER SPRING

- 5 per package
- Stainless steel

Fits: Transport Drive Shaft Assembly (Developer and Fixer Transport Module)
Models: 810 & 9000



RPI Part #PHC020
OEM Part #866-010007

TRANSPORT DRIVE CHAIN

- Stainless steel

Fits: Developer and Fixer Transport Module
Models: 810 & 9000

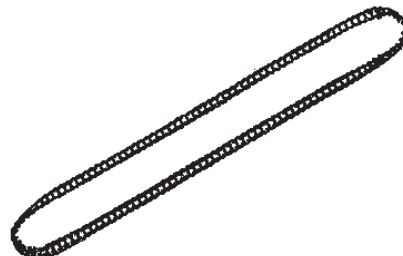

RPI Part #PHC021
OEM Part #867-010007

WASHER/DRYER DRIVE CHAIN

- Stainless steel

Fits: Washer/Dryer Transport Module
Models: 810 & 9000

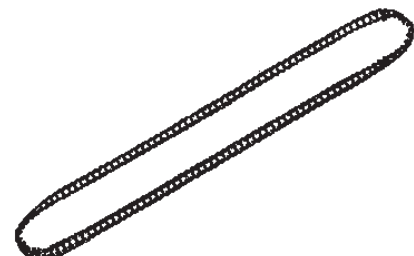

Dental Equipment

Models: 810 & 9000 Developer, Fixer & Washer/Dryer Transport Module (continued)

RPI Part #PHG009
OEM Part #875-000007

GEAR

- 10 per package
- Plastic
- 3/16" ID, 12 Teeth

Fits: Developer, Fixer and Washer/Dryer Transport Module
Models: 810 & 9000



RPI Part #PHS013
OEM Part #875-040007

SPROCKET

- 10 per package
- Plastic
- 3/16" ID, 9 Teeth

Fits: Developer, Fixer and Washer/Dryer Transport Module
Models: 810 & 9000



RPI Part #PHG010
OEM Part #875-010007

GEAR

- 10 per package
- Plastic
- 1/4" ID, 12 Teeth

Fits: Developer, Fixer and Washer/Dryer Transport Module
Models: 810 & 9000



RPI Part #PHS014
OEM Part #875-050007

SPROCKET

- 10 per package
- Plastic
- 1/4" ID, 9 Teeth

Fits: Developer, Fixer and Washer/Dryer Transport Module
Models: 810 & 9000



RPI Part #PHG011
OEM Part #875-020007

GEAR

- 2 per package
- Plastic
- 3/16" ID, 27 Teeth

Fits: Developer and Fixer Transport Module
Models: 810 & 9000



RPI Part #PHA022
OEM Part #866-022007

INGRESS DRIVE SHAFT ASSEMBLY

- Stainless steel
 - Includes gear (RPI Part #PHG012), and large knurl pin (RPI Part #PHP019)
- Fits:** Ingress Plastic Roller Assembly (RPI Part #PHR025) (Developer and Fixer Transport Module)
Models: 810 & 9000



RPI Part #PHG012
OEM Part #875-030007

GEAR

- Stainless steel
- 1/4" ID, 12 Teeth

Fits: Large Knurl Pin (RPI Part #PHP019), Gear with Drilled Shaft and Ingress Plastic Roller Assembly (RPI Part #PHR025) (Developer, Fixer and Washer/Dryer Transport Module)
Models: 810 & 9000



RPI Part #PHA023
OEM Part #866-021007

GEAR WITH DRILLED SHAFT

- Stainless steel
 - Includes gear (RPI Part #PHG012), and drilled shaft
- Fits:** Developer and Fixer Transport Module
Models: 810 & 9000



Our friendly, knowledgeable customer service representatives are here to assist you.

RPI Part #PHR001
OEM Part #874-000007

#1 RUBBER ROLLER

- 1/4" OD stainless steel shaft
- Includes retaining clip (RPI Part #PHC015)

Fits: Developer, Fixer and Washer/Dryer Transport Module
Models: 810 & 9000

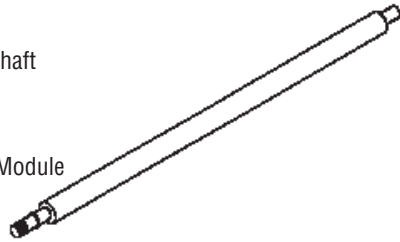

RPI Part #PHR002
OEM Part #874-010007

#2 RUBBER ROLLER

- 1/4" OD stainless steel shaft
- Includes retaining clip (RPI Part #PHC015)

Fits: Developer, Fixer and Washer/Dryer Transport Module
Models: 810 & 9000

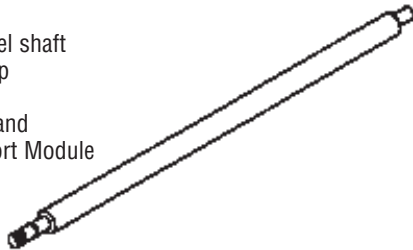

RPI Part #PHR003
OEM Part #874-020007

#3 RUBBER ROLLER

- 1/4" OD stainless steel shaft
- Knurled both ends

Fits: Developer, Fixer and Washer/Dryer Transport Module
Models: 810 & 9000

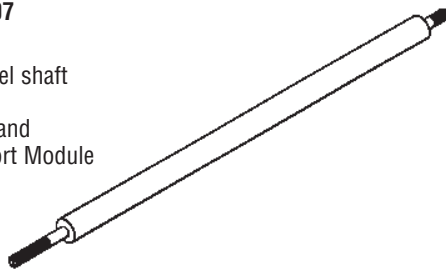

RPI Part #PHR004
OEM Part #874-030007

SHORT PIN ROLLER

- Plastic
- Includes stainless steel short double knurl pin (RPI Part #PHP016), and short middle knurl pin (RPI Part #PHP018)

Fits: Developer, Fixer and Washer/Dryer Transport Module
Models: 810 & 9000

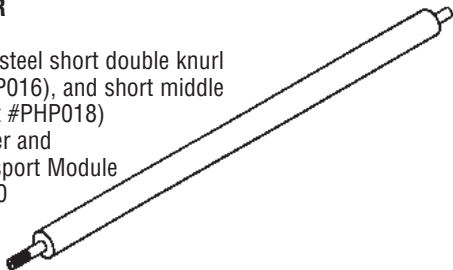

RPI Part #PHR005
OEM Part #874-040007

LONG PIN ROLLER

- Plastic
- Includes stainless steel long double knurl pin (RPI Part #PHP017), and short middle knurl pin (RPI Part #PHP018)

Fits: Developer, Fixer and Washer/Dryer Transport Module
Models: 810 & 9000

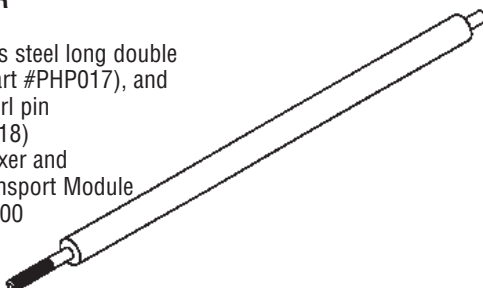

RPI Part #PHR006
OEM Part # N/A

INGRESS ROLLER

- Plastic
- Includes stainless steel short middle knurl pin (RPI Part #PHP018), and large knurl pin (RPI Part #PHP019)

Fits: Developer, Fixer and Washer/Dryer Transport Module
Models: 810 & 9000

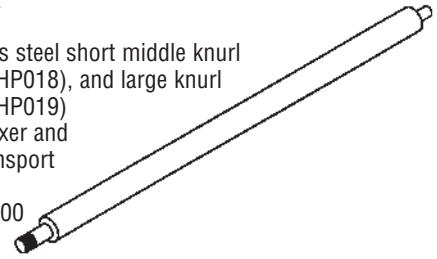

RPI Part #PHH007
OEM Part #874-070007

HANGER ASSEMBLY

- Plastic
- Includes plastic spreader, (2) plastic hanger, and (2) 1/4-20 x 1-1/2" Allen head screw

Fits: Developer, Fixer and Washer/Dryer Transport Module
Models: 810 & 9000

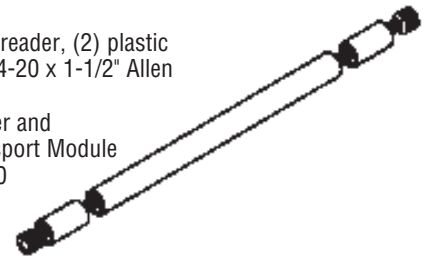

RPI Part #PHS008
OEM Part #874-081007

SPREADER ASSEMBLY

- Plastic
- Includes spreader, and (2) 1/4-20 x 5/8" stainless steel panhead screw

Fits: Developer, Fixer and Washer/Dryer Transport Module
Models: 810 & 9000

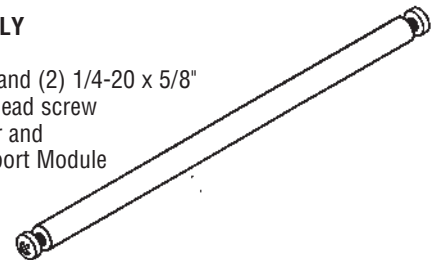

RPI Part #PHR025
OEM Part #874-060007

INGRESS ROLLER ASSEMBLY

- Plastic
- Includes stainless steel short middle knurl pin (RPI Part #PHP018), and ingress drive shaft assembly (RPI Part #PHA022)

Fits: Developer, Fixer and Washer/Dryer Transport Module
Models: 810 & 9000

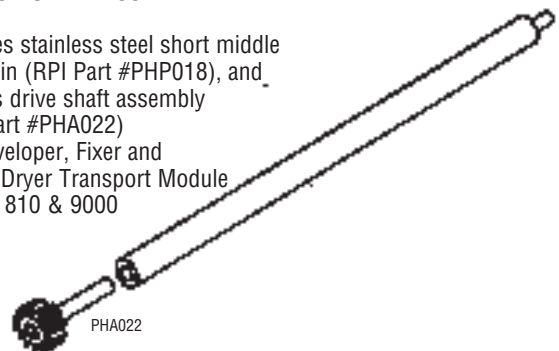

RPI is the best source for all your replacement parts.

Dental Equipment

Models: P4, P6 & P10

RPI Part #LIB001
New OEM Part #268-117
Old OEM Part #805-0016

DRIVE BELT (SHORT DRYER)

- 100 x L025 Timing Belt
- Effective belt length: 10"
- Belt width: 1/4"
- Grooves per inch: 5
- Pitch (measured from center line of tooth to center line of next tooth: 0.200

Fits: Dryer Rack
Models: P4, P6 & P10

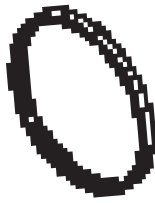

RPI Part #LIB002
New OEM Part #268-116
Old OEM Part #805-0017

MAIN DRIVE BELT

- 100 x L037 Timing Belt
- Effective belt length: 10"
- Belt width: 3/8"
- Grooves per inch: 5
- Pitch (measured from center line of tooth to center line of next tooth: 0.200

Fits: Main Drive System
Models: P4 & P6 only



RPI Part #LIB003
New OEM Part #268-118
Old OEM Part #805-0019

DRIVE BELT

- 160 x L025 Timing Belt
- Effective belt length: 16"
- Belt width: 1/4"
- Grooves per inch: 5
- Pitch (measured from center line of tooth to center line of next tooth: 0.200

Fits: Dryer Rack
Models: P4, P6 & P10



BELT CHART	QTY. INDICATES NUMBER OF BELTS REQUIRED PER RACK					
	QTY	MODEL P4	QTY	MODEL P6	QTY	MODEL P10
Developer Rack	2	LIB004	2	LIB004	2	LIB004
Fixer Rack	1	LIO005	1	LIO005		
	2	LIB004	2	LIB004	2	LIB004
Washer Rack	2	LIB004	2	LIB004	2	LIB004
Dryer Rack	1	LIB003	1	LIB003	1	LIB003
	1	LIB001	1	LIB001	1	LIB001

RPI Part #LIB004
New OEM Part #268-119
Old OEM Part #805-0007

DRIVE BELT

- 170 x L025 Timing Belt
- Effective belt length: 17"
- Belt width: 1/4"
- Grooves per inch: 5
- Pitch (measured from C/L of tooth to C/L of next tooth: 0.200

Fits: Developer, Fixer, and Washer Racks
Models: P4, P6 & P10



RPI Part #LIO005
New OEM Part #268-120
Old OEM Part #805-0009
Industry Part #2-155

O-RING

- Material: Buna-N (Nitrile)
 - Hardness: 70 Duro
 - ID: 4.011, OD: 4.219, C/S: .104
- Fits:** Developer and Fixer Racks
Models: P4 & P6 only

O-Ring illustrations are actual size

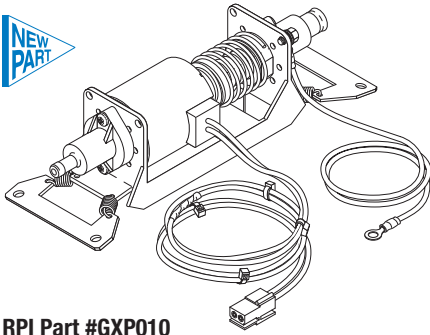

RPI Part #GXP010
OEM Part #112-0529G1

OSCILLATING PUMP

- 115VAC, .38 AMP, 25W
- 24" lead wires with connector
- Includes mounting brackets with springs
- Also available: Tubing (RPI Part #RPT652), Kwik™ Clamps (RPI Part #RPC637) and Silicone Gasket Maker 598 (RPI Part #RPS639)

Fits: Film Processor
Model: GXP

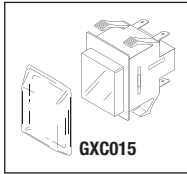

RPI Part #GXS013
OEM Part #632-0046P1

PUSH BUTTON SWITCH (WHITE)

- Run/Stand-by and On/Off Switches
- 3/16" quick connect tab
- DPST normally open
- 10A @ 125/250VAC
- Includes all parts as shown

Fits: Switch Panel
Model: GXP

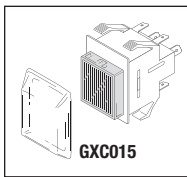

RPI Part #GXS014
OEM Part #632-0045P1

PUSH BUTTON SWITCH (RED)

- Illuminated Endo Switch
- 3/16" quick connect tab
- DPST normally open
- 10A @ 125/250VAC
- Includes all parts as shown

Fits: Switch Panel
Model: GXP



RPI Part #GXC015
OEM Part #433-0060P1

SWITCH COVER

- Transparent protective cover boot
 - Use with Push Button Switches (RPI Part #'s GXS013 & GXS014)
- Fits:** All Push Button Switches and Lamps
Model: GXP

RPI Part #GXB009
OEM Part #420-0007P1

DRIVE BELT

- 190XL025 Power Grip Timing Belt
- Effective belt length: 19"
- Belt width: .25"
- Grooves per inch: 5
- Pitch (measured from center line of tooth to center line of next tooth): .200"
- Number of teeth: 95

Fits: Developer, fixer, wash and dryer racks
Model: GXP

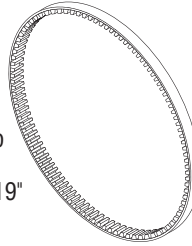

RPI Part #GXG007
OEM Part #303-0015P1

DRIVE GEAR

- Helical/pulley gear
- Material: Black Delrin®

Fits: Racks; Developer, Fixer and Wash
Model: GXP

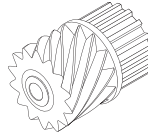

RPI Part #GXG008
OEM Part #112-0579G1

DRIVE GEAR

- Helical/pulley/spur gear
- Material: Black Delrin®

Fits: Dryer Racks
Model: GXP

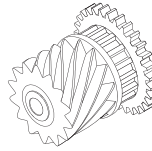

RPI Part #PHG009
OEM Part #303-0016P1 (White)
& #303-0016P2 (Black)

GEAR

- 10 per package
- Material: White plastic
- 3/16" ID, 12 teeth
- This White Gear fits the Ideler Roller (5A #303-0016P1), and can also be used to replace the Black Gear that fits the Driver Roller (5B #303-0016P2)

Fits: Ideler Roller and Driver Roller
Model: GXP

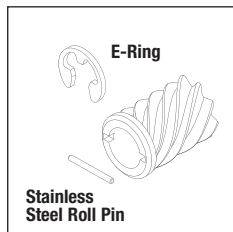
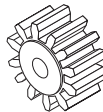

RPI Part #GXK006
OEM Part #112-0635G1

HELICAL GEAR KIT

- Gear material: Black Delrin®
- Includes all parts as shown

Fits: Drive Shaft
Model: GXP

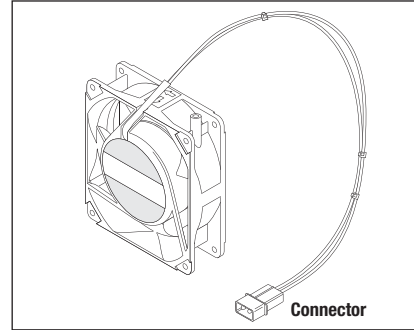

RPI Part #GXF011
OEM Part #122-0096G1

COOLING FAN

- 3.15" square x 1" wide
- 115VAC
- Airflow: 17-20 CFM
- Precision ball bearing
- Aluminum housing
- Includes all parts as shown

Fits: Back Panel
Model: GXP

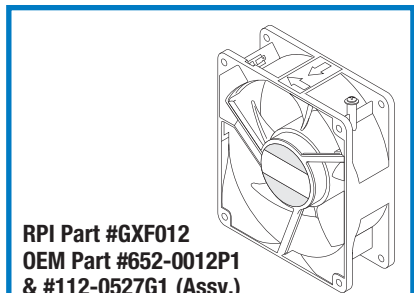

RPI Part #GXF012
OEM Part #652-0012P1
& #112-0527G1 (Assy.)

HEATER FAN

- 4.69" square x 1.5" wide
- 115VAC
- Airflow: 88-102 CFM
- Precision ball bearings
- Aluminum housing

Fits: Heater/Fan Assembly
Model: GXP

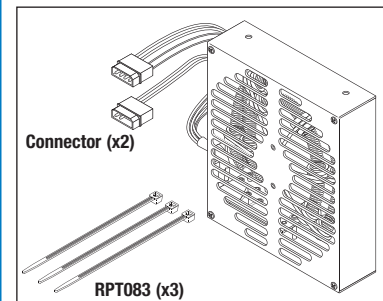

RPI Part #GXH039
OEM Part #112-0094G1
& #112-0527G1 (Assy.)

HEATER

- 4.68" square x 1.25" wide
- 120VAC, 750W
- Thermally protected
- Includes all parts as shown

Fits: Heater/Fan Assembly
Model: GXP

Dental Equipment

Model: GXP™

RPI Part #G XK041

OEM Part # (No OEM Part # Available)

MASTER TUBING KIT

- Includes (1 ea) of RPI Part #'s GXK026, GXK027, GXK028, GXK029, GXK030 and GXK031 – see details below.

Fits: Fluid Interface Assembly to Solution Container **Model:** GXP

INCLUDES ALL INLET & OUTLET TUBING KITS FOR A COMPLETE REBUILD!

Color Coded Spirals For Easy Identification!

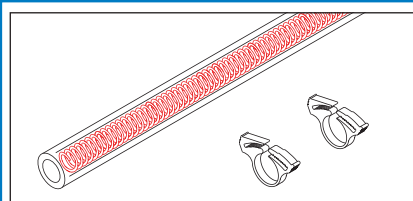
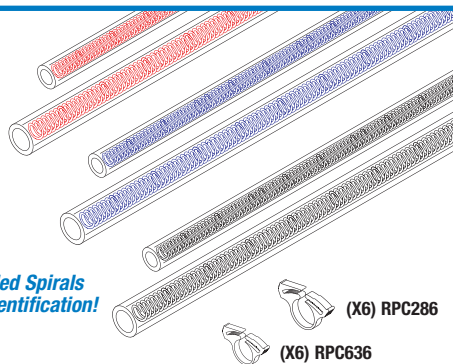

RPI Part #G XK026
OEM Part #112-0623G1

INLET TUBING KIT (RED)

- Includes 6' of 3/8" ID PVC Clear Tubing (RPI Part #RPT646), (2) 3/8" OD x 3' lg. Red Spiral Insert (RPI Part #GXS032) & (2) Kwik™ Clamp (RPI Part #RPC636)

Fits: Fluid Interface Assembly to Solution Container **Model:** GXP

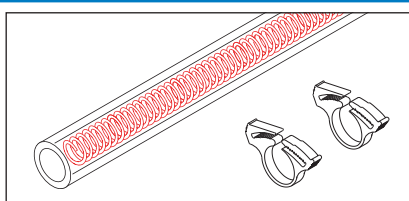

RPI Part #G XK029
OEM Part #112-0622G1

OUTLET TUBING KIT (RED)

- Includes 6' of 1/2" ID PVC Clear Tubing (RPI Part #RPT647), (2) 1/2" OD x 3' lg. Red Spiral Insert (RPI Part #GXS035) & (2) Kwik™ Clamp (RPI Part #RPC286)

Fits: Fluid Interface Assembly to Solution Container **Model:** GXP

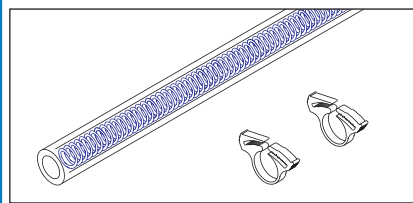

RPI Part #G XK027
OEM Part #112-0623G2

INLET TUBING KIT (BLUE)

- Includes 6' of 3/8" ID PVC Clear Tubing (RPI Part #RPT646), (2) 3/8" OD x 3' lg. Blue Spiral Insert (RPI Part #GXS033) & (2) Kwik™ Clamp (RPI Part #RPC636)

Fits: Fluid Interface Assembly to Solution Container **Model:** GXP

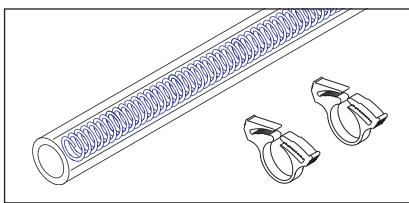

RPI Part #G XK030
OEM Part #112-0622G2

OUTLET TUBING KIT (BLUE)

- Includes 6' of 1/2" ID PVC Clear Tubing (RPI Part #RPT647), (2) 1/2" OD x 3' lg. Blue Spiral Insert (RPI Part #GXS036) & (2) Kwik™ Clamp (RPI Part #RPC286)

Fits: Fluid Interface Assembly to Solution Container **Model:** GXP

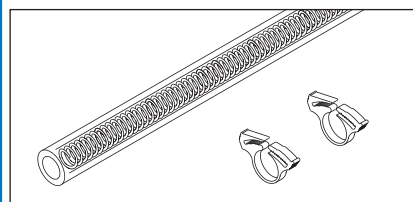

RPI Part #G XK028
OEM Part #112-0623G3

INLET TUBING KIT (CLEAR)

- Includes 6' of 3/8" ID PVC Clear Tubing (RPI Part #RPT646), (2) 3/8" OD x 3' lg. Black Spiral Insert (RPI Part #GXS034) & (2) Kwik™ Clamp (RPI Part #RPC636)

Fits: Fluid Interface Assembly to Solution Container **Model:** GXP

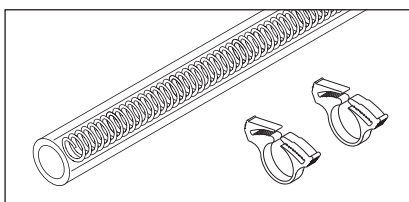

RPI Part #G XK031
OEM Part #112-0622G3

OUTLET TUBING KIT (CLEAR)

- Includes 6' of 1/2" ID PVC Clear Tubing (RPI Part #RPT647), (2) 1/2" OD x 3' lg. Black Spiral Insert (RPI Part #GXS037) & (2) Kwik™ Clamp (RPI Part #RPC286)

Fits: Fluid Interface Assembly to Solution Container **Model:** GXP

RPI Part #GXS032

OEM Part # (No OEM Part # Available)

SPIRAL INSERT (RED 3/8" OD)

- Material: PVC; Color: Red
- Fits:** Inlet Tubing **Model:** GXP

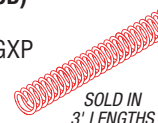

RPI Part #GXS035

OEM Part # (No OEM Part # Available)

SPIRAL INSERT (RED 1/2" OD)

- Material: PVC; Color: Red
- Fits:** Outlet Tubing **Model:** GXP

RPI Part #GXS033

OEM Part # (No OEM Part # Available)

SPIRAL INSERT (BLUE 3/8" OD)

- Material: PVC; Color: Blue
- Fits:** Inlet Tubing **Model:** GXP

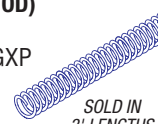

RPI Part #GXS036

OEM Part # (No OEM Part # Available)

SPIRAL INSERT (BLUE 1/2" OD)

- Material: PVC; Color: Blue
- Fits:** Outlet Tubing **Model:** GXP

RPI Part #GXS034

OEM Part #407-0156P1

SPIRAL INSERT (BLACK 3/8" OD)

- Material: PVC; Color: Black
- Fits:** Inlet Tubing **Model:** GXP



RPI Part #GXS037

OEM Part #407-0156P2

SPIRAL INSERT (BLACK 1/2" OD)

- Material: PVC; Color: Black
- Fits:** Outlet Tubing **Model:** GXP

RPI Part #RPC286

OEM Part #407-0159P5

KWIK™ CLAMP (6/pkg)

- Clamping Range: 11/16" - 13/16" (.688" - .812")
- Fits:** 11/16" OD Tubing **Model:** GXP



RPI Part #RPC636

OEM Part #407-0159P2

KWIK™ CLAMPS (6/pkg)

- Clamping Range: 15/32" - 17/32" (.468"-.594")
- Fits:** 1/2" OD Tubing **Model:** GXP

Nylon (White)

RPI Part #RPT646

OEM Part # (No OEM Part # Available)

TUBING (CLEAR 3/8" ID PVC)

- 3/8" ID x 1/2" OD; Sold by the foot
- Fits:** Inlet Fitting **Model:** GXP

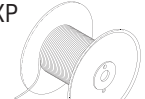

RPI Part #RPT647

OEM Part # (No OEM Part # Available)

TUBING (CLEAR 1/2" ID PVC)

- 1/2" ID x 11/16" OD; Sold by the foot
- Fits:** Outlet Fittings and Internal Pump Connections **Model:** GXP

Does not include reel

RPI Part #GXM002
OEM Part #112-0534G1

DRIVE MOTOR

- 1/30 Hp, 90VDC, 25 RPM
- Includes all parts as shown

Fits: Drive Motor
Model: GXP

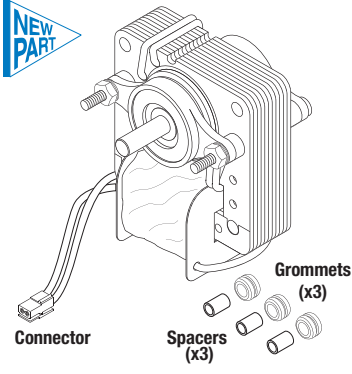
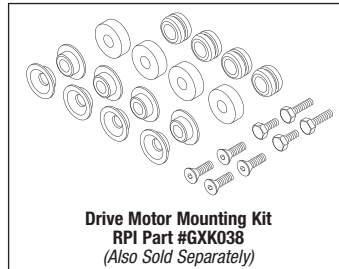
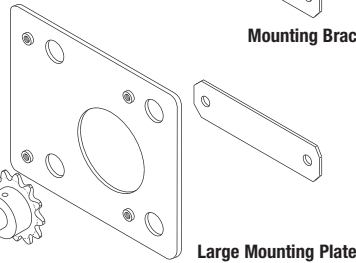
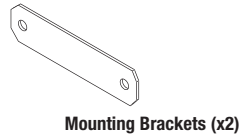
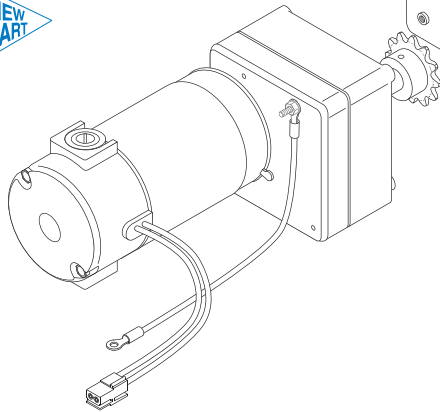

RPI Part #GXM023
OEM Part #112-0531G1

AGITATOR MOTOR

- 120VAC, 60 Hz., 3000 RPM
- Impedance protected
- 1/4" dia. shaft; 3/4" lg.
- Sealed ball bearings
- Includes all parts as shown

Fits: Agitator Assembly (Bottom Tanks)
Model: GXP



RPI Part #G XK038
OEM Part # (OEM Part # Not Available)

DRIVE MOTOR MOUNTING KIT

- Includes all parts as shown

Fits: Drive Motor
Model: GXP

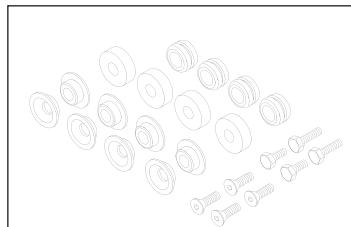

- Includes:**
- (2) #10-32 x 1/2" Hex Head Screws
 - (2) #10-32 x 3/4" Hex Head Screws
 - (4) #10-32 x 3/4" Flat Head Screws
 - (4) Screw Retainer Top
 - (4) Screw Retainer Bottom
 - (4) Grommets
 - (4) Spacers

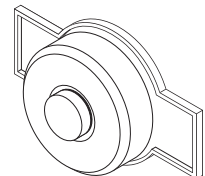

RPI Part #GXA025
OEM Part #112-0563G1

SOLUTION AGITATOR

- Magnetic material

Fits: Solution Tank
Model: GXP

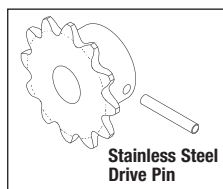

RPI Part #GXS003
OEM Part #303-0042P1

SPROCKET

- Dark grey glass filled nylon
- 12 tooth
- 1.08" OD
- 5/16" bore
- For #25 (1/4" pitch) Roller Chain
- Includes all parts as shown

Fits: Main Drive Motor
Model: GXP

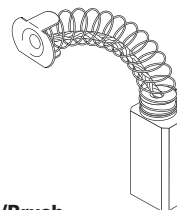

RPI Part #GXB004
OEM Part #652-0015P1/Brush

MOTOR BRUSH

- 2 per package
- .187" x .312" x .625"
- Radius: 1/2"
- Spring length: .88"
- Copper shunt wire
- Cap sold separately (RPI Part #RPC038)

Fits: Brush Holder Assembly On
Main Drive Motor

Model: GXP



RPI Part #RPC038
OEM Part #652-0015P1/Cap

BRUSH CAP

- 6 per package
- Material: Bakelite
- 1/2-27 thread
- Brush sold separately (RPI Part #GXB004)

Fits: Main Drive Motor
Model: GXP

Dental Equipment

Model: GXP™

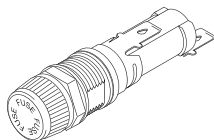

RPI Part #RPH638
OEM Part # 646-0047P1

FUSE HOLDER (MAIN)

- 3/16" quick connect tabs
- Fits standard 1/4" x 1-1/4" fuse
- 20A @ 250VAC
- Includes mounting hardware

Fits: Rear Panel
Model: GXP

RPI Part #RPF070
OEM Part #646-0048P1

FUSE (MAIN) (12A, 250VAC)

- 5 per package
- Type: Ceramic; MDA Time Delay
- Size: 1/4" x 1-1/4"

Fits: Fuse Holder (Main)
Model: GXP

RPI Part #RPF045
OEM Part #646-0054P16

FUSE (1A, 250VAC)

- 5 per package
- Type: Glass; AGC Fast Acting
- Size: 1/4" x 1-1/4"

Fits: PC Board Position: F1
Model: GXP

RPI Part #RPF046
OEM Part #46-170021P34

FUSE (1-1/2A, 250VAC)

- 5 per package
- Type: Glass; AGC Fast Acting
- Size: 1/4" x 1-1/4"

Fits: PC Board Position: F2
Model: GXP

RPI Part #RPF053
OEM Part #46-170021P33

FUSE (8A, 250VAC)

- 5 per package
- Type: Glass; AGC Fast Acting
- Size: 1/4" x 1-1/4"

Fits: PC Board Position: F3
Model: GXP

RPI Part #RPF512
OEM Part # (No OEM # Available)

FUSE (1A, 250VAC)

- 5 per package
- Type: Glass; Fast Acting
- Size: 5mm x 20 mm

Fits: PC Board Position: F4
Model: GXP

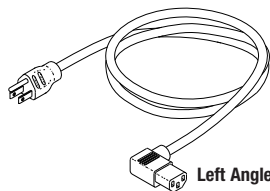

Left Angle Plug

RPI Part #RPC291
OEM Part #644-0009P1

INDUSTRIAL GRADE POWER CORD

- Length: 6 ft.
- 14/3 SJT, 105°C; 15A @ 125VAC
- NEMA 5-15P; EN60320-C13L Left Angle

Model: GXP

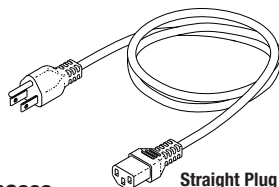

Straight Plug

RPI Part #RPC262
OEM Part # (No OEM # Available)

INDUSTRIAL GRADE POWER CORD

- Length: 10 ft.
- 14/3 SJT, 60°C; 15A @ 125VAC
- NEMA 5-15P; EN60320-C13

Model: GXP



RPI Part #RPC637
OEM Part #407-0159P1

KWIK™ CLAMPS (6/pkg)

- Material: Nylon; Color: White
- Clamping Range: 23/64" - 25/64" (.359" - .390")

Fits: 3/8" OD Tubing (Pump Tubing)
Model: GXP

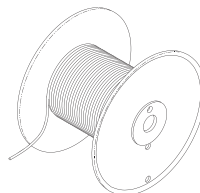

RPI Part #RPT652
OEM Part #273-0010P1

TUBING (1/4" TYGON®)

- Pump tubing
- 1/4" ID x 3/8" OD
- Black
- Sold by the foot (Does not include reel)

Fits: Pump and Pump Connections
Model: GXP



RPI Part #RPS639
OEM Part # (No OEM # Available)

SILICONE GASKET MAKER 598

- 5 per package
- .05 fl. oz. per unit
- Material: RTV Black Silicone
- Provides a sealant for the pump tubing connections

Model: GXP

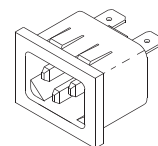

RPI Part #HBM011
OEM Part #651-0068P1

POWER MODULE

- 15A @ 250VAC
- 1/4" quick connect tabs

Fits: Rear Panel
Model: GXP

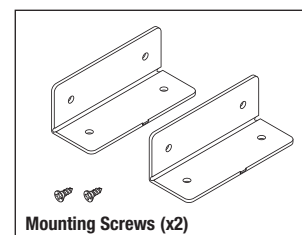

Mounting Screws (x2)

RPI Part #GXK040
OEM Part #406-0015P1

HINGE KIT

- 1-1/2" x 2"
- Plastic hinge (white)
- Includes all parts as shown

Fits: Upper Cover to Bottom Frame
Model: GXP

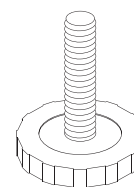

RPI Part #GXF024
OEM Part #112-0629G1

LEVELING FOOT

- 4 per package
- 1.50" dia. non-skid PVC base
- 3/8-16 x 1-1/4" lg. stainless steel stud

Fits: Bottom Frame
Model: GXP

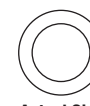

Actual Size

RPI Part #RPO360
OEM Part #404-0036P2
Industry Part #AS568-011

O-RING

- 6 per package
- .301" ID x .441" OD x .070" C/S
- Material: EPDM
- Duro: 80

Fits: Standpipe
Model: GXP

RPI Part #AMB028
OEM Part #93-90-029

LIGHT BULB

- Standard NE51 bulb
- Fits:** Light socket
- Models:** 660 & Mark III



RPI Part #AIS034
OEM Part # N/A

LIGHT SOCKET

- 120V
- Accommodates standard NE51 bulb
- Uses lens caps (RPI Part #AIC035--AIC044)
- Fits:** Front panel
- Model:** 660 & Mark III

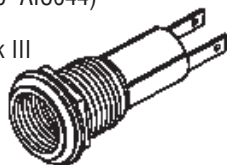

RPI Part #AIC035
OEM Part #93-90-330

LENS CAP (RED)

- Fits:** Light socket
- Model:** 660 & Mark III



RPI Part #AIC036
OEM Part #93-90-329

LENS CAP (WHITE)

- Fits:** Light socket
- Model:** 660 & Mark III



RPI Part #PCL027
OEM Part # N/A

"POWER ON" LIGHT (RED)

- Includes light, and (2) quick disconnect (.250 female tab, 18-14 AWG)

Fits: Front panel
Model: 650 & Mark II

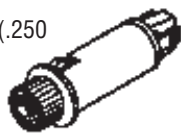

RPI Part #PCL028
OEM Part # N/A

"HEAT ON" LIGHT (AMBER)

- Includes light, and (2) quick disconnect (.187 female tab, 22 x 16 AWG)

Fits: Front panel
Model: 650 & Mark II



RPI Part #RCB096
OEM Part #93-90-065

BUZZER

- 120 Volt, 60 Hz, .05 Amps
- 6" wire leads with 1/4" quick disconnect terminals

Fits: Chassis/Control Module
Models: All ovens

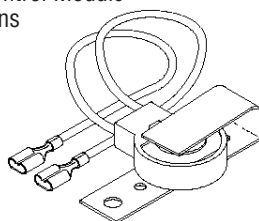

RPI Part #MDT012
OEM Part # N/A

TIMER WITH BELL

- 60 minute mechanical timer
- Includes timer, face plate, and mounting nut

Fits: Chassis
Models: Mark II

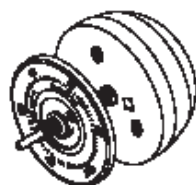

RPI Part #MDK018
OEM Part # N/A

VACUUM CONTROL KNOB

- Fits:** Vacuum valve shaft
- Models:** 660, Mark III & Mark IV (New style valve only)

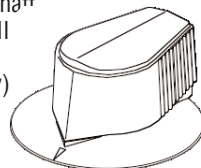

RPI Part #BUK042
OEM Part # N/A

TEMPERATURE ADJUSTMENT KNOB

- Fits:** Pyrometer shaft
- Models:** 650, 660, Mark II, Mark III on older meters only



RPI Part #PCS133
OEM Part # N/A

CASING SCREW

- 12 per package
- 10-24 x 3/8
- Slotted binder head
- Stainless steel

Fits: Speednut
Models: All ovens



RPI Part #PCN136
OEM Part # N/A

SPEEDNUT

- 10 per package
- "U" type 10-24 thread

Fits: Chassis
Models: All ovens



RPI Part #ADS129
OEM Part # N/A

POWER SWITCH (VACUUM PUMP SWITCH)

- SPST
- 20A, 125VAC; 10A 250VAC
- Includes (2) Pig Tail (RPI Part #RPT014)

Fits: Vacuum chamber assembly
Model: 650 & Mark II

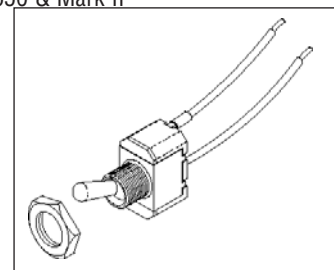

RPI Part #PCC004
OEM Part #93-90-401

POWER CORD WITHOUT CONNECTORS

- 8 ft.
- Rated: 16 AWG
- 3 conductor
- Type: HSJO (90°C heater cord)

Fits: Back panel
Models: All ovens

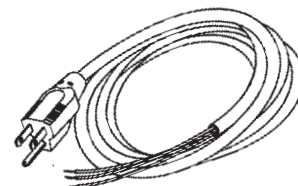

RPI guarantees your satisfaction with every part you order!

Dental Equipment

Porcelain Ovens - Ney Dental *(continued)*

Model: 650, 660, Mark II, Mark III & Mark IV

RPI Part #RPB159
OEM Part #93-90-361

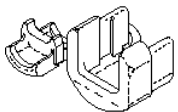

STRAIN RELIEF BUSHING

- 6 per package
- UL/CSA Type SR-7P-2
- Wall or panel thickness 1/8" maximum
- AWG/Conductors 18/2-18/3, 16/2-16/3
- Mounting hole diameter 3/4"
- Also in Strain Relief Bushing Kit (RPI Part #RPK412)

Fits: Back panel
Models: All ovens

RPI Part #RPT172

STRAIN RELIEF BUSHING PLIERS

- Hand pliers adjustable for all bushings that assemble into to 7/

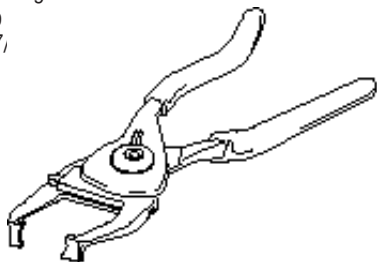

RPI Part #RP0315
OEM Part # N/A
Industry Part #2-009



O-RING

- 12 per package
- Material: Buna-N (Nitrile)
- Hardness: 70 Duro
- ID: .208, OD: .348, C/S: .070

Fits: Vacuum Valve Stem
Models: All ovens

New RPI Part #RP0303
OEM Part # N/A
Industry Part #2-012

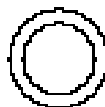

O-RING

- 12 per package
- Material: Buna-N (Nitrile)
- Hardness: 70 Duro
- ID: .364, OD: .504, C/S: .070

Fits: Vacuum Valve Stem
Models: All ovens

RPI Part #RPA032

THREADLOCKER 242

- 5 per package
- .02 FL. OZ per unit
- Prevents rust and corrosion
- Removable adhesive by Loctite®



RPI Part #RPW086

HIGH TEMPERATURE WIRE (WHITE)

- Sold by the foot
- Teflon® insulated
- Type EE, 1000V
- Maximum operating temperature 200°C
- Fits:** Muffle leads to plug
- Models:** All ovens



DON'T FORGET!

RPI Part #RPL090

HIGH TEMP LUBRICANT

- 5 per package
- 1/2 gram each package
- **Non-silicone** lubricant
- Temperature range: -40°F to +400°F

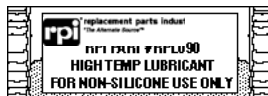

See GENERAL SHOP AIDS section for High Temperature Wire in other gauges and colors.

RPI is name you can trust for quality parts - We Guarantee It!

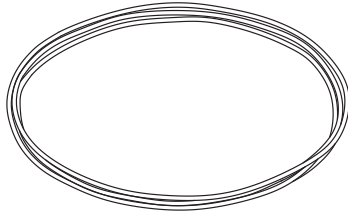

RPI Part #WLB002
OEM Part #AS404

BELT (6' 6")

- Material: Pyrrathane
 - Size: .093" dia. C/S x 6' 6" circumference
- Models:** Arms: AS051 (Whisper short arm) and Arms: AS011 (Piccolo engine arm)

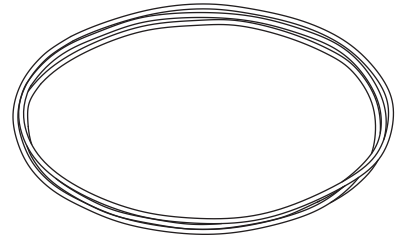

RPI Part #WLB003
OEM Part #AS406

BELT (9' 8")

- Material: Pyrrathane
 - Size: .093" dia. C/S x 9' 8" circumference
- Models:** Arms: AS052 (Whisper long arm) and Arms: AS012 (Standard engine arm)

RPI Part #PCC004
OEM Part # (No OEM Part # Available)

POWER CORD WITHOUT CONNECTORS

- Length: 8 ft.; Color: Black
- 16/3; 105°C; 13A @ 125VAC
- Plug Type: NEMA 5-15P
- Connector Type: None; 0.33" OD Cord
- Service Tip: When replacing power cord, use a new Strain Relief Bushing (RPI Part #RPB164)

Fits: Motor Hood
Models: Hood & Motor: E026, E027, E028 & E029

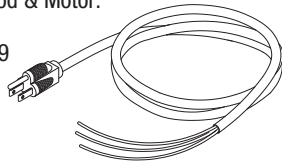

RPI Part #RPB164
OEM Part # (No OEM Part # Available)

STRAIN RELIEF BUSHING

- 8 per package
- Type: SR-6N3-4
- Mounting Hole: 5/8" x 1/8" THK max.
- Cord Type: .325" - .360" round cable
- Use when replacing power cord (RPI Part #PCC004)
- Also included in: Strain Relief Bushing Kit (RPI Part #RPK412)

Fits: Motor Hood
Models: Hood & Motor: E026, E027, E028 & E029

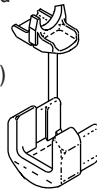

RPI Part #RPT172
OEM Part # (No OEM Part # Available)

STRAIN RELIEF BUSHING PLIERS

- Hand pliers adjustable for all bushings that assemble into mounting hole up to 7/8" diameter
 - Size: ~ 7" lg.
- Models:** Hood & Motor: E026, E027, E028 & E029

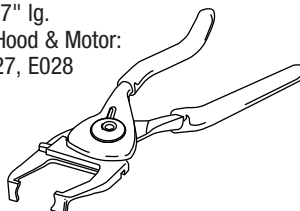

RPI Part #CAF011
OEM Part # (No OEM Part # Available)

RUBBER FOOT

- 4 per package
- Material: Black rubber with molded in steel washer
- Size: ~ .750" O.D. x .50" lg.; #10 clearance hole

Fits: Foot Control and Hood
Models: Hood & Motor: E026, E027, E028 & E029 and Foot Controls: F011 & F013

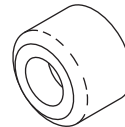

RPI Part #RPT017
OEM Part # (No OEM Part # Available)

WIRE NUT

- 15 per package
- Range: #22-#16 AWG (Gray)
- Also included in: Crimp-On Wire Connector & Wire Nut Kit (RPI Part #RPK401)

Models: Hood & Motor: E026, E027, E028 & E029

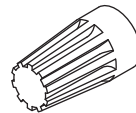

RPI Part #RPF051
OEM Part # (No OEM Part # Available)

FUSE (5A, 250V)

- 5 per package
- Type: AGC Glass, Fast-Acting
- Size: 1/4" dia. x 1-1/4" lg.
- Also included in: Fuse Kit (Fast-Acting) (RPI Part #RPK410)

Fits: Foot Control Fuse Holder
Models: Foot Controls: F011 & F013

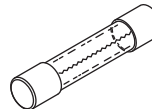

RPI Part #WLB001
OEM Part #E-101



BRUSH

- 2 per package
- Size: .125" x .187" x .596" lg.
- Radius: .470"
- Spring Length: .75"
- Copper shunt wire

Models: Hood & Motor: E026, E027, E028 & E029 and Motor: Baldor - E132 & E133

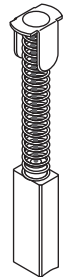

RPI Part #DRB001
OEM Part #E-105

BRUSH

- 2 per package
- Size: .250" x .375" x .817" lg.
- Radius: .625"
- Spring length: 1.375"

Models: Hood & Motor: E026, E027, E028 & E029 and Motor: Bodine (Large brush) - E-131

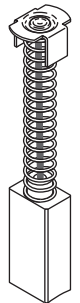

RPI Part #BDB001
OEM Part #E-107

BRUSH

- 2 per package
- Size: .250" x .187" x .650" lg.
- Radius: None
- Spring Length: 1.100"
- MFG 1983-1987

Models: Hood & Motor: E026, E027, E028 & E029 and Motor: Bodine (Small brush) - E-129 & E-130

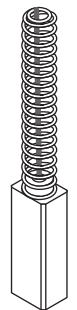

RPI Part #EMB001
OEM Part #E-106

BRUSH

- 2 per package
- Size: .250" x .250" x .657" lg.
- Radius: .500"
- Spring Length: 1.343"

Models: Hood & Motor: E026, E027, E028 & E029 and Motor: WSM

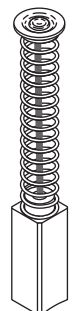

Dental Equipment

Ray Foster Dental Equipment

Model: 10" & 12" Trimmer

RPI Part #ADS129
OEM Part #M081

POWER SWITCH

- SPST
 - 20A @ 125VAC; 12A @ 250VAC
 - Includes all parts as shown
- Fits:** Motor, Switch Cover Plate
Model: All models

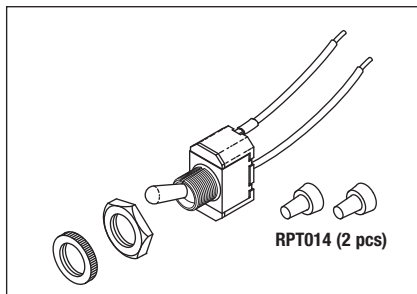

RPI Part #PCF179

OEM Part # (No OEM Part # Available)

RUBBER FOOT ASSEMBLY

- 2 per package
- Includes all parts as shown

Fits: Lower Frame
Models: All models

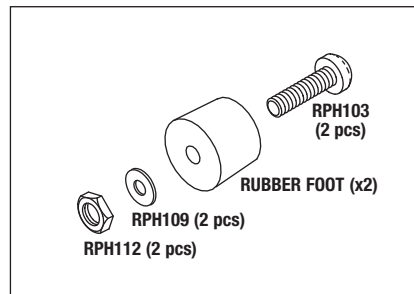

Whip Mix

Model: Vac-U-Vester

RPI Part #ADS129
OEM Part #M081

POWER SWITCH

- SPST
 - 20A @ 125VAC; 12A @ 250VAC
 - Includes all parts as shown
- Fits:** Housing
Model: D

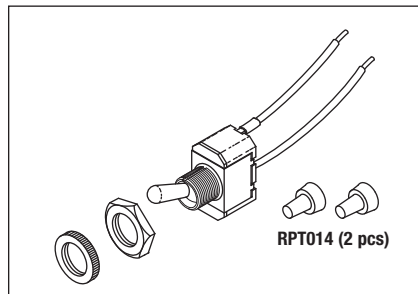

RPI Part #PCF179

OEM Part # (No OEM Part # Available)

RUBBER FOOT ASSEMBLY

- 2 per package
 - Includes all parts as shown
- Fits:** Bottom plate assembly
Models: Table top models

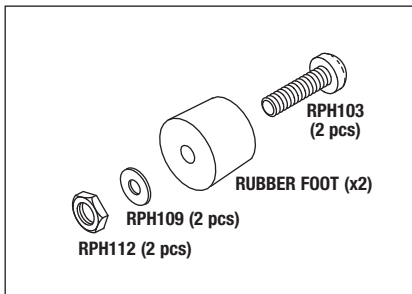

RPI Part #GOL022

OEM Part # (No OEM Part # Available)

ROTARY PUMP OIL

- 4 fl. oz.
 - Includes yorker spout
 - ISO68
 - For MSDS, see RPI website
- Fits:** All Rotary Pumps (dispenses into oil reservoir)

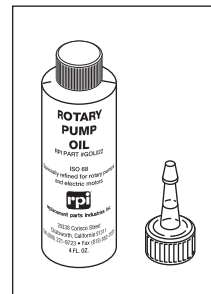

RPI Part #PCC004
OEM Part #6001C

POWER CORD WITHOUT CONNECTORS

- Length: 8 ft.; Color: Black
- 16/3; 105°C; 13A @ 125VAC
- Plug Type: NEMA 5-15P
- Connector Type: None; 0.33" OD Cord
- Service Tip: When replacing power cord, use a new Strain Relief Bushing (RPI Part #RPB159)

Fits: Motor pump
Models: All models

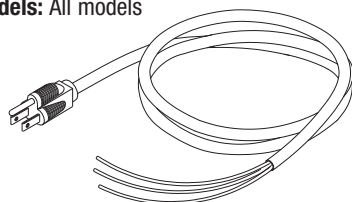

RPI Part #RPB159

OEM Part #6206

STRAIN RELIEF BUSHING

- 6 per package
- Type: SR-7P-2
- Mounting hole: 3/4" x .125 THK max.
- Cord type: .360" x .430" round cable
- Also included in: Strain Relief Bushing Kit (RPI Part #RPK412)

Fits: Motor pump
Model: D combination unit

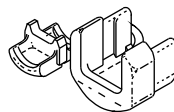

RPI Part #RPT172

OEM Part # (No OEM Part # Available)

STRAIN RELIEF BUSHING PLIERS

- Hand pliers adjustable for all bushings that assemble into mounting hole up to 7/8" diameter
- Size: ~ 7" lg.

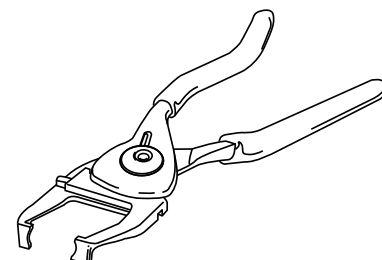

RPI Part #LMP604
Industry Part #ENZ

LAMP

- 30V, 50W
- Base: 2-pin
- Models:** EFOS Lite, Henry Schein, Kinetic Instrument Sunspot, L.D. Caulk (Prisma-Lite), MDT (Rolux II), Proden Executor, S.S. White Profile Curing Lite & Teledyne Getz Focus

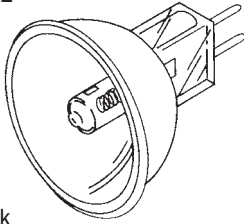

RPI Part #LMP605
Industry Part #ETJ

LAMP

- 120V, 250W
- Base: 2-pin, special
- Models:** Chapman Huffman, Midwest (Insight I & II), Kavo (Curing Light), Healthco (VCL Illum.), Lares (Quartz Fire SX) & Vicon (LS, DLS, Polor II)

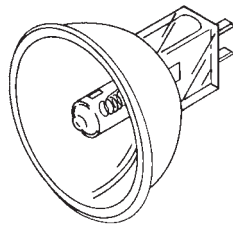

RPI Part #LMP606
Industry Part #ELZ

LAMP

- 21V, 150W
- Base: 2-pin
- Models:** Midwest (Oral Illuminator II & III)

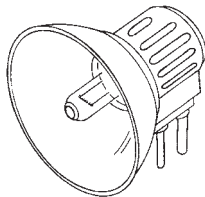

RPI Part #LMP603
Industry Part #EJL

LAMP

- 24V, 200W
- Base: 2-pin
- Models:** Caulk (Prisma) & MDT (Rolux I)

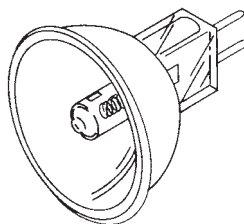

RPI Part #LMP600
Industry Part #FCS

LAMP

- 24V, 150W
- Base: 2-pin
- Also available: Socket (RPI Part #ADS125) to fit A-dec
- Models:** Faro (original unit Sunlight 70), Eurodent & J. Morita



RPI Part #LMP609
OEM Part #041.709.00/041.179.00/041.179.01/28.1004.00 (Bulb & Holder only)

LAMP (17V, 95W)

- Halogen Bulb
- G6.35 2-Pin base
- Also available: Lamp Socket Assembly (RPI Part #ADS125)
- Fits:** Light Socket Assembly
- Models:** A-dec 6300 Series



RPI Part #LMP601
Industry Part #H-3

LAMP

- 12V, 55W
- PK22S base style with 1/4" quick connect tab
- Halogen
- Also available: Socket (RPI Part #BES012) to fit Belmont X-Calibur
- Models:** A-dec Performer, Belmont X-Calibur Models 040, 046, 047 & 048, Chayes Light, Fiad (The Light) & Healthco Aristocrat and X-Calibur

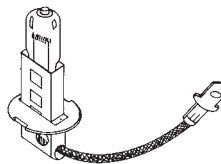

RPI Part #LMP026
OEM Part #501074

LAMP

- 24 VDC, 60W
- PK22S base style with 1/4" quick connect tab
- Black tip on bulb
- Halogen
- Models:** Belmont Clesta 501, 502 & 505



RPI Part #LMP602
Industry Part #125T10/P

LAMP

- 120V, 125W
- Base: Medium, prefocus
- Models:** Castle (Panavision)



RPI Part #LMP607
Industry Part #FDS/DZE

LAMP

- 24V, 150W
- Base: 2-pin
- Models:** Ritter (Knight, "K" Super Starlite), Faro (Koolbeam, Sunlight S-90 & 70 upgrade) Henry Schein Starbrite, Marus Starbrite & Porter Daystar S-90B

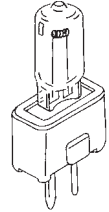

RPI Part #LMP608
Industry Part #75T3Q/CL; 075/CL/DC-28

LAMP

- 28V, 75W
- Base: Double contact, bayonet
- Halogen
- Models:** Ritter "J" (Starlite)

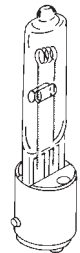

RPI Part #AMB028
Industry Part #NE51

LIGHT BULB

- T-3-1/4 mini bayonet
- 120V, .3ma
- Also available: Light Socket (RPI Part #AIS034), Lens Cap (Red) (RPI Part #AIC035), Lens Cap (White) (RPI Part #AIC036) & Lens Cap (Amber) (RPI Part #AIC037)
- Fits:** Panel Light Sockets
- Models:** Aristocrat (1022), Dynaclave 613R (576A), 8816A, 8816M (608A), Ney Dental Porcelain Ovens (660 & Mark III) & Volt/Matt

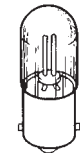

RPI Part #PCL606
Industry Part #150T4Q/CL25V
P&C OEM #3321879 (017133)

LAMP

- 25V, 150W
- Base: Double ended
- Halogen
- Also available: Sockets (RPI Part #'s PCS605 & PCS607) and Socket Retractor Tool (RPI Part #PCT685) to fit Pelton & Crane
- Models:** All Pelton & Crane LF, LF+, LFII, LFIII, LFIIS & LFIISE

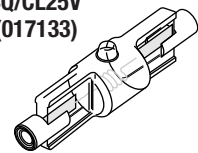

RPI Part #PCT685
P&C OEM #006800

SOCKET RETRACTOR TOOL

- Size: ~ 3-1/4" lg.
- For installation of Lamp (RPI Part #PCL606)
- Models:** Pelton & Crane LFI & LF+

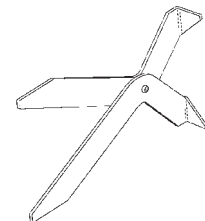

RPI Part #ADL126
OEM Part #28-0503-01

LENS SPLASH SHIELD

- Clear plastic
- Mounting hardware not included

Fits: Light head

Models: 6300 Series

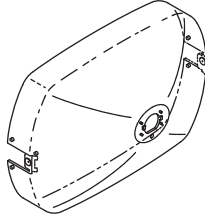

RPI Part #ADR185
OEM Part # (No OEM Part # Available)

REFLECTOR

- New glass - Not Re-coated
- Includes all parts as shown

Fits: Light head

Models: 6300 Series

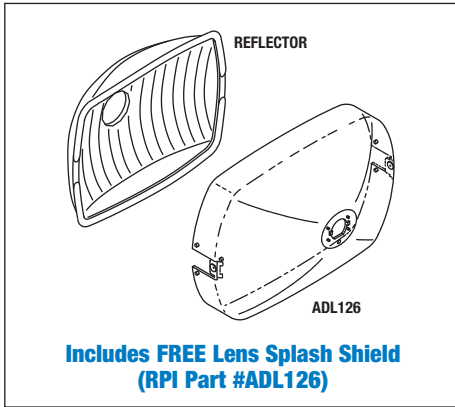

RPI Part #ADK269
OEM Part #28.0503.02

LENS KIT

- Includes all parts as shown
- All parts sold separately
- Also available: Lever & Bracket Kit (RPI Part #ADK274)

Fits: Lens Assembly
Models: 6300 Series

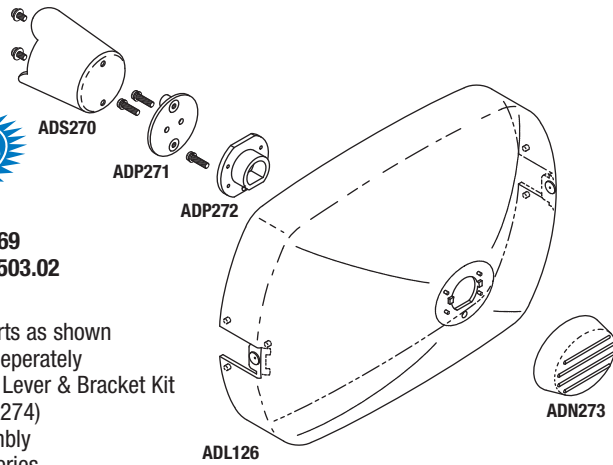

RPI PART #	OEM PART #	DESCRIPTION	MATERIAL	QTY PER PACKAGE
ADL126	28-0503-01	Lens Splash Shield	Clear Plastic	1
ADN273	75.007.00 & 28.0504.00	Nosepiece	Plastic	1
ADP271	28.0554.00	Mount Plate (Lamp Shield) • Includes: Mounting Screw	Plastic	1
ADP272	28.0553.00	Mount Plate (Nosepiece) • Includes: Mounting Screw	Plastic	1
ADS270	28.0555.00	Lamp Shield • Includes: (2) Mounting Screws	Flat Black Steel	1

RPI Part #ADK258
OEM Part #28.0770.00 (Bearing Sleeve only)/**018.063.00** (Black Hole Plug only)/**28.1536.00** (Surf Hole Plug only)

PIVOT TENSION KIT

- Includes all parts as shown
- All parts sold separately

Fits: Yoke Assembly
Models: 6300 Series

Note: The assembly order of the parts included in our Pivot Tension Kit vary dramatically depending upon the Light Head. The Light Heads will use all or some of the parts included in our Pivot Tension Kit.

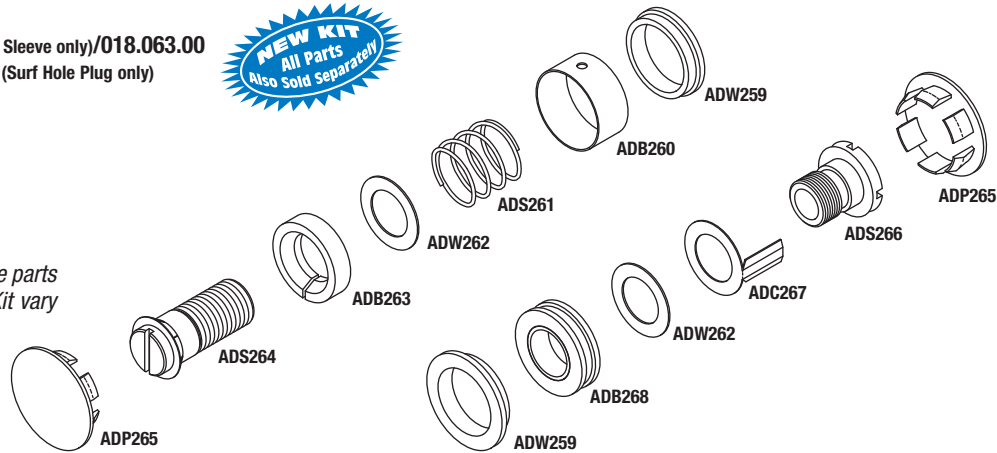

RPI PART #	OEM PART #	DESCRIPTION	MATERIAL	KIT QUANTITY	REORDER QUANTITY
ADB260	28.0770.00	Bearing Sleeve	Nickel Plated Brass	1	1
ADB263	No OEM Part # Available	Bushing (Right)	White Plastic	1	1
ADB268	No OEM Part # Available	Bushing (Left)	White Plastic Sleeve & Brass Bushing	1	1
ADC267	No OEM Part # Available	Ground Contact	Copper	1	1
ADP265	018.063.00 (Black) & 28.1536.00 (Surf)	Hole Plug	Off-White Plastic	2	2
ADS261	No OEM Part # Available	Spring	Music Wire	1	1
ADS264	No OEM Part # Available	Screw (Tension Adj. Right)	Brass	1	1
ADS266	No OEM Part # Available	Screw (Tension Adj. Left)	Brass	1	1
ADW259	No OEM Part # Available	Washer (Sleeve)	White Plastic	2	1
ADW262	No OEM Part # Available	Flat Washer	White Plastic	2	1

Call Us Toll-Free Monday-Friday, 8:00 AM-4:30 PM (Pacific Time), (800) 221-9723

Dental Equipment

Models: 6300 Series

RPI Part #ADK274
OEM Part #28.1012.00 Surf/
28.0643.00 (Black)



LEVER & BRACKET KIT

- 2 per package
- Color: Gray
- Fits:** Lens Assembly
- Models:** 6300 Series

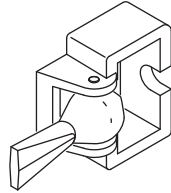

RPI Part #ADS125
OEM Part #28-0633-00

LAMP SOCKET ASSEMBLY

- Includes all parts as shown
- Also available: Lamp (RPI Part #LMP609)
- Fits:** Inside of Focus Tube
- Models:** 6300 Series

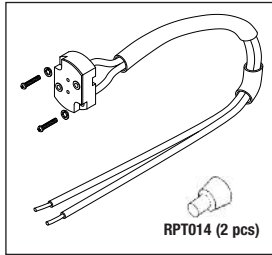

RPI Part #LMP609
OEM Part #041.709.00/041.179.00/
041.179.01/28.1004.00 (Bulb & Holder only)

LAMP (17V, 95W)

- Halogen Bulb
- G6.35 2-Pin base
- Also available: Lamp Socket Assembly (RPI Part #ADS125)
- Fits:** Light Socket Assembly
- Models:** 6300 Series



RPI Part #ADT127
OEM Part #28-0566-00

LOCKING TAB

- Material: Oilite bronze
- Fits:** Pivot Arm to Mounting Hub
- Model:** 6300 Series



RPI Part #ADK275
OEM Part #28.0628.00 (Handle only)/
28.0629.00 (Handle only)



HANDLE INSERT KIT

- 2 per package
- Material: Plastic
- Includes all parts as shown
- Fits:** Handles
- Models:** 6300 Series

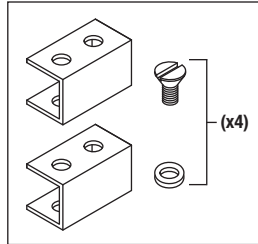

RPI Part #ADS129
OEM Part #041-336-00/90.1039.00

POWER SWITCH

- Toggle switch
- 20A @ 125VAC; 10A @ 250VAC; SPST
- Includes all parts as shown
- Fits:** Head Assembly and Swivel Block
- Models:** 6300 Series

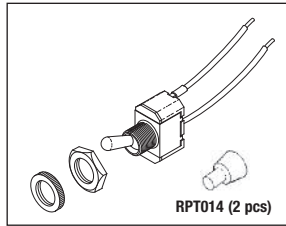

RPI Part #ADS130
OEM Part #041-177-00

INTENSITY SWITCH

- Toggle switch
- 6A @ 125VAC; 3A @ 250VAC
- On-On-On; DPDT; .093" Tabs
- Includes: Mounting hardware
- Fits:** Transformer Housing, Box Assembly and Pivot Arm Assembly
- Models:** 6300 Series

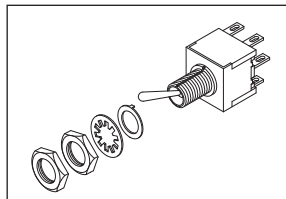

RPI Part #RPH243
OEM Part #046-123-000

CIRCUIT BREAKER

- 10A @ 250VAC
- Includes all parts as shown
- Manual reset
- Fits:** Transformer Housing of Ceiling, Wall, Unit and Track Assembly
- Models:** 6300 Series

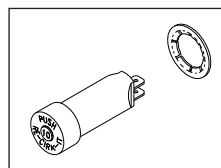

RPI Part #ADT132
OEM Part #28-0724-00/90.1041.00

TRANSFORMER

- 120/240V, 50/60Hz
- Includes all parts as shown
- Fits:** Preference II, Box Assembly
- Models:** 6300 Series

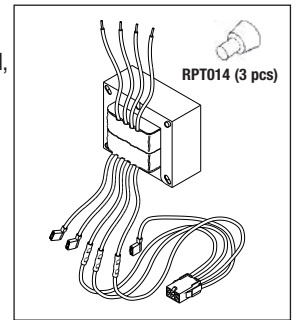

RPI Part #ADT133
OEM Part #28-0822-00/90.1040.00

TRANSFORMER

- 120/240V, 50/60Hz
- Includes all parts as shown
- Fits:** Track Light, Box Assembly
- Models:** 6300 Series (before 1993)

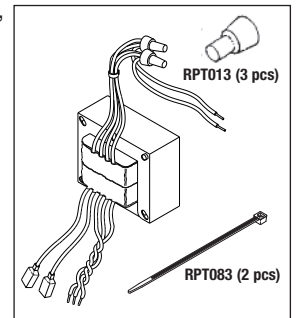

RPI Part #ADT134
OEM Part #28-0720-00/90.1040.00

TRANSFORMER

- 120/240V, 50/60Hz
- Includes all parts as shown
- Fits:** Rigid Arm Assembly on Ceiling, Wall and Unit Mounted Lights
- Models:** 6300 Series - Excellence and Preference I

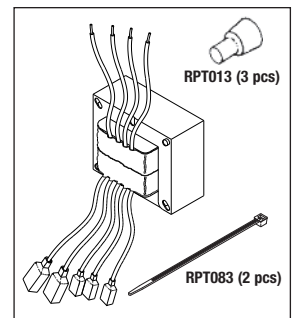

Model: A-dec Performer

RPI Part #LMP601
Industry Part #041-513-00

LAMP

- 12 V, 55 W
- PK22S base style
- Halogen
- 1/4" Quick Connect tab
- Model:** Performer

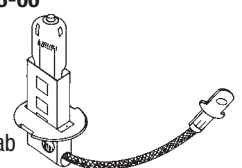

RPI Part #MAR001
 OEM Part #: Knight #152615;
 Marus #52R412; Henry Schein #1702250

REFLECTOR

Includes **FREE** Lens Splash Shield

- Reflectors are new, not re-coated
- Includes Reflector, and Lens Splash Shield (RPI Part #MAL002)

Fits: Light head **without** handles

Henry Schein Models: Crusader Style

Star-bright #'s 800-1, 800-3, 800-5 and 800-7

Knight Model: "L" Operating Light

Marus Models: Luxstar, CL1000, UL1000 and TL1000



RPI Part #MAL002
 OEM Part #: Knight #122845
 Henry Schein/Marus #52R430

LENS SPLASH SHIELD

Fits: Light head **without** handles

Henry Schein Models: Crusader Style

Star-bright #'s 800-1, 800-3, 800-5 and 800-7

Knight Model: "L" Operating Light

Marus Models: Luxstar, CL1000, UL1000 & TL1000



RPI Part #LMP608
 RITTER Part #75T3Q/CL (FDS/DZE)

LAMP

- 28 V, 75 W
- Base: Double contact, bayonet
- Halogen

Fits: Dental Light

Ritter Model: "J" Starlite



RPI Part #LMP607
 OEM Part #: Henry Schein #014R207;
 Knight #121720; Marus #014R207;
 Industry Part #75T3Q/CL

LAMP

- 24 V, 150 W
- Base: 2-pin

Fits: Dental Light

Henry Schein Models: Crusader Style

Star-bright #'s 800-1, 800-3, 800-5 and 800-7

Knight Model: "L" Operating Light

Marus Models: Luxstar, CL1000, UL1000 & TL1000



RPI Part #RCR608
 OEM Part #148774

REFLECTOR with HANDLES

Includes **FREE** Lens Splash Shield

- Reflectors are new, not re-coated
- Includes Reflector, and Lens Splash Shield (RPI Part #RCL609)

Fits: Light head **with** handles

Knight Model: "K" Super Starlite

Ritter Models: "J" Starlite & "K" Super Starlite



RPI Part #RCL609
 OEM Part #148234

LENS SPLASH SHIELD

Fits: Light head **with** handles

Knight Model: "K" Super Starlite

Ritter Models: "J" Starlite & "K" Super Starlite



RPI Part #RPC274
 OEM Part #016392

POWER CORD

- Length: 6 ft. lg.
- Color: Black
- Type: 16/3 SPT-2
- Plug NEMA 5-15P
- Flat-style cord
- Cord is rated 13 A @ 125 VAC

Models: All post mount units only



RPI Part #RCS605
 OEM Part #WO-34566

POWER SWITCH

- 8 A @ 125 VAC
- SPST
- Includes all parts as shown

Fits: Dental Light

Ritter Models: "J" Starlite & "K" Super Starlite

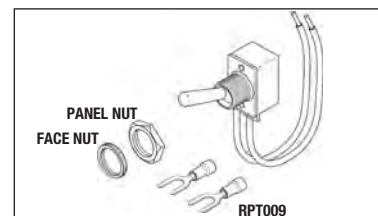

Dental Equipment

Models: Castle (Panavision & Accuvision)

RPI Part #LMP602
Industry Part #125T10/P

LAMP

- 120 V, 125 W
- Base: Medium, prefocus
- Fits:** Dental Light
- Model:** Castle (Panavision)



RPI Part #RCS605
OEM Part #WO-34566

POWER SWITCH

- 8 A @ 125 VAC
- SPST
- Includes all parts as shown
- Fits:** Dental Light
- Model:** Castle (Accuvision)

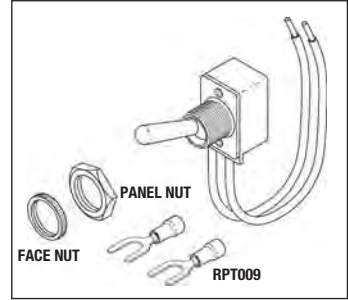

NOTES: _____

RPI Part #BES034
New OEM Part #8000-02005
Old OEM Part #800-02005

FRONT SHIELD

- Clear Lexan®
- 6.250" Dia. x 4.870" Flats x .062" THK.
- Fits:** All oval handles
- Models:** All Belmont X-Calibur with oval handles



RPI Part #BES033
OEM Part #HLU 2005

FRONT SHIELD

- Clear Lexan®
- 6.3" x 5.375" x .062" THK
- Fits:** All square handles
- Models:** All Belmont X-Calibur with square handles; All Healthco X-Calibur with square handles

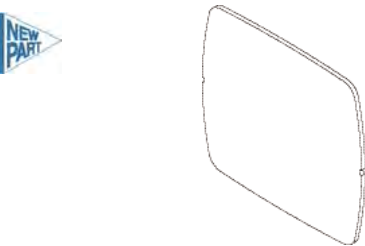

RPI Part #LMP601
Industry Part #H-3

LAMP

- 12 VDC; 55 W
- PK22s base style
- Fits:** Light socket
- Models:** All Belmont X-Calibur models; All Healthco X-Calibur models

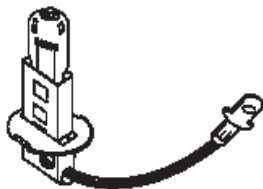

RPI Part #BEH030
OEM Part #HLU 1130

WIRE HARNESS

- Includes connectors
- 6 ft. lg.
- Fits:** Balance arm assembly
- Models:** Belmont X-Calibur 046/BLW & 047/BLC; Healthco X-Calibur 046/HLW & 047/HLC

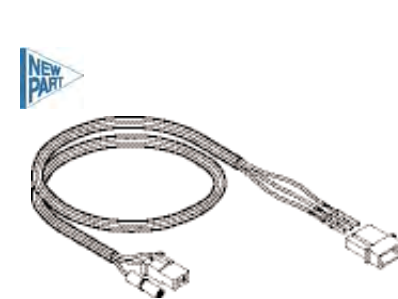

RPI Part #BEH031
OEM Part #HLU 0350

WIRE HARNESS

- Includes connectors
- 10 ft. lg.
- Fits:** Balance arm assembly
- Models:** Belmont X-Calibur HLPW; Healthco X-Calibur BLPW



RPI Part #BEH032
OEM Part #HLU 1140

WIRE HARNESS

- Includes connectors
- 8 ft. lg.
- Fits:** Track mount BLT
- Models:** Belmont X-Calibur 048/BLT; Healthco X-Calibur 048/HLT



RPI Part #BES023
OEM Part #8000-1001

POWER SWITCH

- Includes all parts as shown
- SPDT (On-Off-On); Nylon toggle
- 10 A @ 250 VAC; 15 A @ 125 VAC
- 3/4 hp, 125-250 VAC
- Fits:** Head assembly
- Models:** All Belmont X-Calibur models; All Healthco X-Calibur models

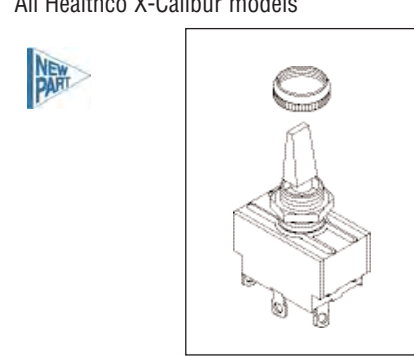

RPI Part #BES006
OEM Part #HLU 2004

SCREW (FRAME BACK COVER)

- Includes all parts as shown
- Stainless
- Special thread: #8-36 UNF
- Fits:** Back frame cover
- Models:** All Belmont X-Calibur models; All Healthco X-Calibur models

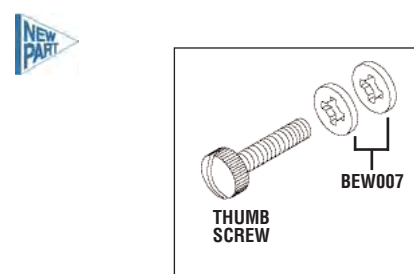

RPI Part #BET029
New OEM Part #HLU 1060

AJUSTMENT TOOL (SPRING TENSION)

- Used to adjust spring tension and head position
- Models:** All Belmont X-Calibur models; All Healthco X-Calibur models

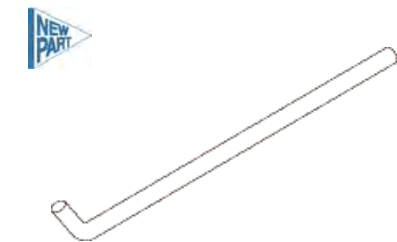

Dental Equipment

Model: Belmont X-Calibur and Healthco X-Calibur

RPI Part #BEK027

OEM Part # (No OEM Part # Available)



LIGHT SOCKET KIT

- Includes all parts as shown
- All parts also sold separately - see below

Fits: Light head assembly

Models: All Belmont X-Calibur models;
All Healthco X-Calibur models

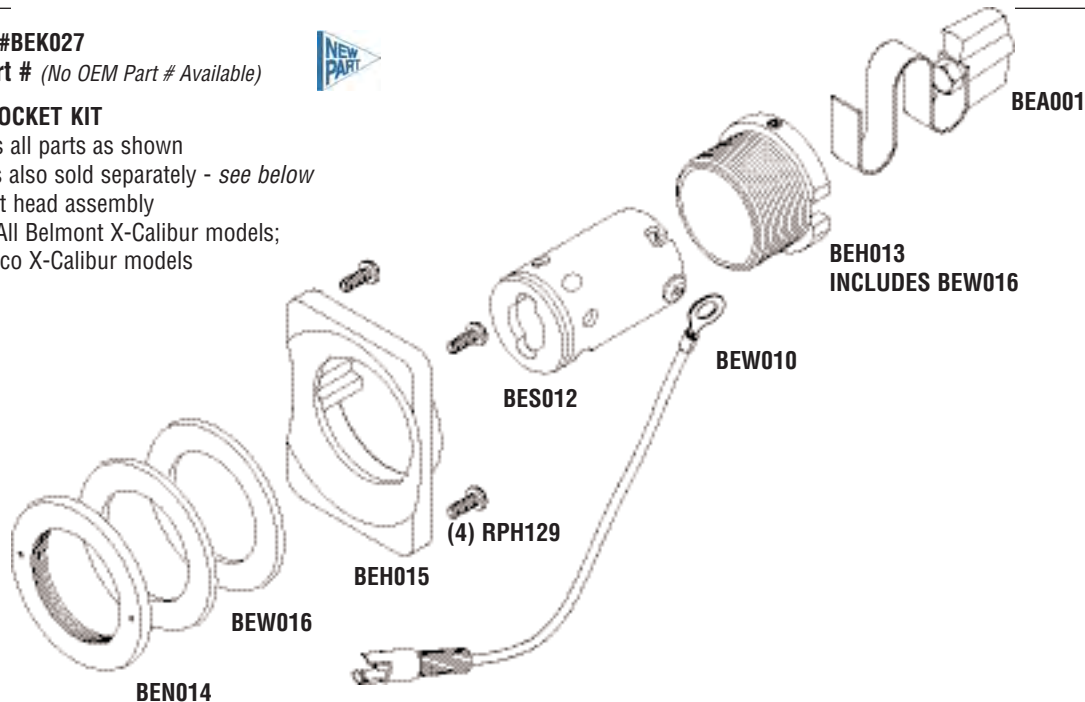

All Parts in Kit Also Sold Separately – See Below!

RPI Part #BEA001

OEM Part #8000-2023

SPRING CLIP HOLDER ASSEMBLY

Fits: Light Socket

Models: All Belmont X-Calibur models;
All Healthco X-Calibur models

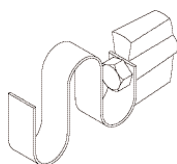

RPI Part #BES012

OEM Part #HLU 2025

LIGHT SOCKET

- Includes all parts as shown

Fits: Light Head Assembly

Models: All Belmont X-Calibur models;
All Healthco X-Calibur models

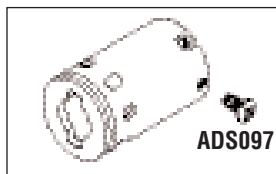

RPI Part #BEH015

OEM Part #HLU 2010

SOCKET HOUSING

- Includes all parts as shown

Fits: Light socket assembly

Models: All Belmont X-Calibur models;
All Healthco X-Calibur models

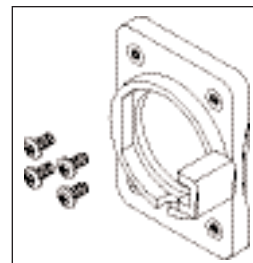

RPI Part #BEH013

OEM Part #8000-2027

SOCKET HOLDER

- Includes all parts a shown
- Brass

Fits: Light head

Models: All Belmont X-Calibur models;
All Healthco X-Calibur models

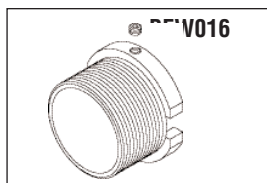

RPI Part #BEW010

New OEM Part #HLU 2026

GROUNDING WIRE ASSEMBLY

Fits: Light socket assembly

Models: All Belmont X-Calibur models;
All Healthco X-Calibur models



RPI Part #BEW016

New OEM Part #HLU 2011

RUBBER WASHER

- 2 per package
- 1.210" ID x 1.780" OD x .087" THK
- Clear silicone

Fits: Both sides of reflector assembly

Models: All Belmont X-Calibur models;
All Healthco X-Calibur models



RPI Part #BEN014

OEM Part #HLU 2012

NUT (SOCKET HOLDER)

- Anodized black

Fits: Light socket holder

Models: All Belmont X-Calibur models;
All Healthco X-Calibur models



Dental Equipment

Model: Belmont Clesta 501, Clesta 502 & Clesta 505



RPI Part #BES044
OEM Part #501071

FRONT SHIELD

- Material: Clear plastic
- Fits:** Light Head
- Models:** Clesta 501, 502 & 505

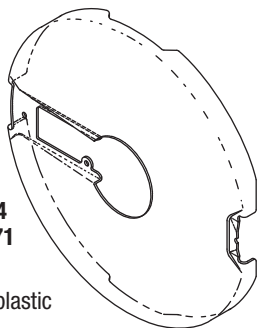

RPI Part #LMP026
OEM Part #501074

LAMP

- 24VDC, 60W
- PK22S base style with 1/4" quick connect tab
- Black tip on bulb
- Halogen
- Models:** Clesta 501, 502 & 505



RPI Part #BES046
OEM Part #501073

SPRING CLIP

- Material: Stainless steel wire
- Also Available: Lamp (Black Tip) (RPI Part #LMP026)
- Fits:** Lamp Socket Assembly
- Models:** Clesta 501, 502 & 505

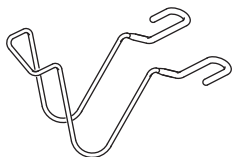

RPI Part #BES050
OEM Part #501058

PROTECTIVE RUBBER SHEET

- Material: Black rubber
- Fits:** Bracket T
- Models:** Clesta 501, 502 & 505

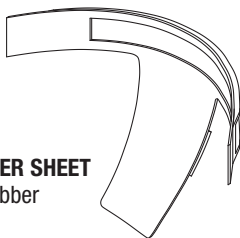

RPI Part #BEC049
OEM Part #501026

YOKE WIRE COVER

- 2 per package
- Material: Black rubber
- Fits:** Bracket T
- Models:** Clesta 501, 502 & 505

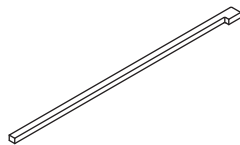

RPI Part #BEH048
OEM Part #501044 (Silicone Tubing only)/**501045** (Silicone Tubing only)/**501046** (4 Pin-Connector, Male & Harness G set only)/**501049** (4 Pin-Connector, Female only)

HARNESS (TOUCHLESS SWITCH)

- ~ 20" lg.
- Includes all parts as shown
- Fits:** Yoke Assembly
- Models:** Clesta 501, 502 & 505



RPI Part #BEC041
OEM Part #501054 (Touchless Switch Cover Kit only)/**501055** (Touchless Switch Cover only)/**501056** (Tape only)

TOUCHLESS SWITCH COVER

- Material: Transparent smoked plastic lens
- Includes: Touchless Switch Cover and Die Cut 2-Sided Tape
- Fits:** Bracket T
- Models:** Clesta 501, 502 & 505

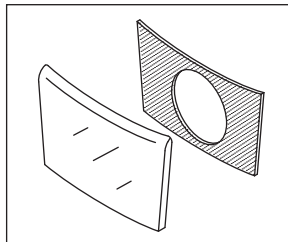

RPI Part #BEH047
OEM Part #501016 (1 Pin-Connector Female only)/**501043** (Silicone Tubing only)/**501047** (Harness I with Connector Pin & Cover only)/**501048** (Harness H with Connector Pin only)

HARNESS (LIGHT)

- ~27.50" lg.
- Includes all parts as shown
- Fits:** Yoke Assembly
- Models:** Clesta 501, 502 & 505

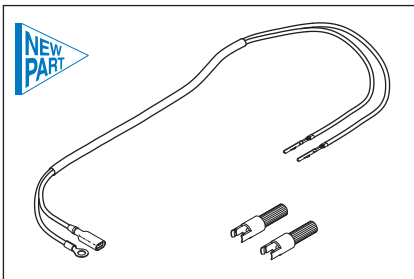

RPI Part #BES035
OEM Part #501009 (Assembly only)/**501010** (Intensity Switch only)/**501011** (2P-Connector & Harness B set only)/**501012** (2P-Connector Female)/**501013** (Harness with Connector Pin only)/**501014** (Harness with Connector Pin only)/**501015** (1P-Connector & Harness D set only)/**501016** (1P-Connector Female only)/**501017** (Harness D with Connector Pin only)/**501018** (1P-Connector & Harness C set only)/**501019** (1P-Connector Male only)/**501020** (Harness C with Connector Pin only)

INTENSITY SWITCH

- 6A @ 125VAC, 3A @ 250VAC
- 3 position (low, medium, high)
- Includes all parts as shown
- Fits:** Rear Yoke Mount Cover
- Models:** Clesta 501, 502 & 505

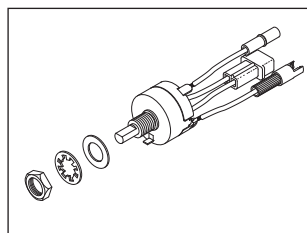

RPI Part #BEK051
OEM Part #501003 (Screw (M3x5) only)/**501004** (External Tooth Washer only)/**501005** (Nut only)/**501006** (Washer (35-29-0.25) only)/**501008** (Yoke Screw only)

YOKE PIVOT KIT

- Includes all parts as shown
- Fits:** Yoke Assembly
- Models:** Clesta 501, 502 & 505

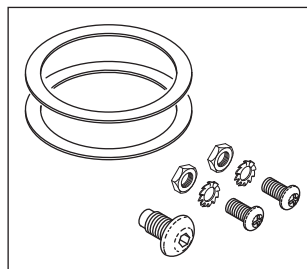

RPI Part #BEK037
OEM Part #501031 (Shaft only)/**501032** (Set Screw only)/**501033** (Washer only)/**501034** (Wave Washer only)/**501035** (Washer only)/**501041** (Retaining Ring only)/**501042** (Washer only)

YOKE DRIFT KIT

- 2 sets per package
- Material: Zinc plated steel
- Includes all parts as shown
- Fits:** Yoke Assembly
- Models:** Clesta 501, 502 & 505

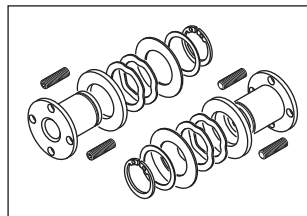

SERVICE TIP

If you are replacing the original **TROLLEY BRACKET ASSEMBLY** with RPI Part #PCA657 (pictured below), you must also replace the wire harness with RPI Part #PCW620 (pictured below). The connectors on the original assembly are obsolete and were replaced by a new style connector.

RPI Part #PCA657
OEM Part #001030

TROLLEY BRACKET ASSEMBLY

Fits: Trolley to Track Power Cord connection and Wire Harness (RPI Part #PCW620)

See **SERVICE TIP** above

Models: LFT & LFT+

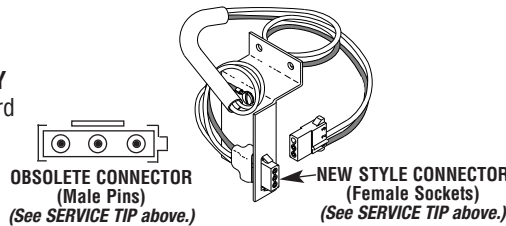

RPI Part #PCW620
OEM Part #013721

WIRE HARNESS

• Plugs into Trolley Bracket Assembly
Fits: Track Trolley Power Cord Connection

See **SERVICE TIP** above

Models: LFT & LFT+

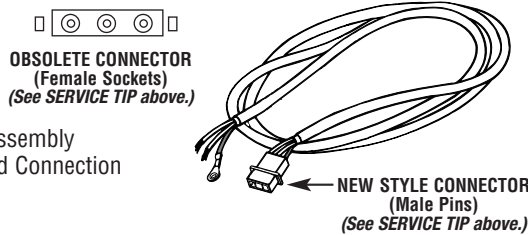

RPI Part #PCS604
New OEM Part #3321853
Old OEM Part #007096

POWER SWITCH

- SPST
- 15 A @ 125 VAC
- Toggle with 1-1/2" long bat handle and mounting hardware
- Includes all parts as shown

Fits: Switch Plate

Models: All LF & LF+

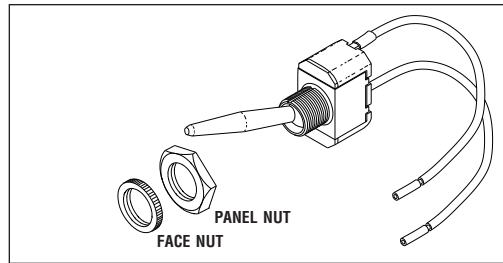

RPI Part #CAG035
OEM Part #017187

COVER GASKET

- 1/4" diameter; 36" long
- Black neoprene sponge
- Retains light socket wiring

Fits: Light Head, Yoke Groove

Models: All LF & LF+

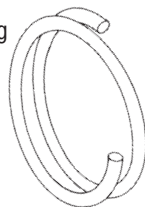

RPI Part #PCT685
OEM Part #006800

SOCKET RETRACTOR TOOL

- For installation of lamp (RPI Part #PCL606)

Models: All LF & LF+

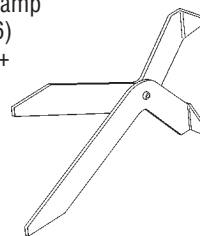

RPI Part #PCR709
New OEM Part #022438
Old OEM Part #H33-006698

REFLECTOR WITH LENS SPLASH SHIELD

- New - Not Re-coated
- Includes all parts as shown

Fits: Light Head

Models: All LF & LF+



RPI Part #PCL612
OEM Part #006777

LENS SPLASH SHIELD

- Lexan® protective shield

Fits: Lens Assembly

Models: All LF & LF+



RPI Part #PCL606
New OEM Part #3321879
Old OEM Part #017133

LAMP

- 25 V, 150 W
- Base: Double ended
- Halogen
- Requires Socket Retractor Tool (RPI Part #PCT685) for installation

Models: All LF & LF+

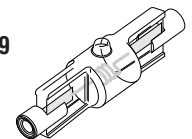

RPI Part #PCP712
OEM Part #006701

PRESSURE PAD

- 2 per package
- Fits:** Light Head

Models: All LF & LF+

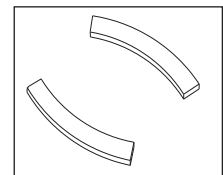

It's a GE Socket!

RPI Part #PCS605
OEM Part #007028

LIGHT SOCKET

- Made by GE
- Fits:** Socket Holder

Models: All LF & LF+

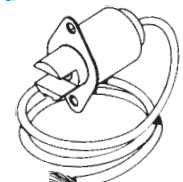

Visit RPI's Website www.rpiparts.com

Call Us Toll-Free Monday-Friday, 8:00 AM-4:30 PM (Pacific Time), (800) 221-9723

Dental Equipment

Models: LF & LF+ Series (continued)



FOR YOUR SAFETY

Use a Main Arm Spring Safety Pin (RPI Part #PCP691) to lock the Main Arm Spring Assembly in place before you service or replace the following:

- RPI Part #PCA692 Wire Harness Assembly
- RPI Part #PCC646 Knuckle & Rod Connector
- RPI Part #PCP663 Connector Hinge Pin
- RPI Part #PCK645 Arm Knuckle
- RPI Part #PCR699 Leveling Rod & Nut
- RPI Part #PCP662 Arm Hinge Pin

RPI Part #PCP691
OEM Part #022676

MAIN ARM SPRING SAFETY PIN

- See "FOR YOUR SAFETY" above.
- Stainless steel

Fits: Holes in tubular Spring Guide of Main Arm Spring Assembly

Models: All LF, LF+ & LFC+

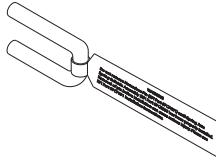

RPI Part #PCC646
OEM Part #006718

KNUCKLE & ROD CONNECTOR

- See "FOR YOUR SAFETY" above.
- Part is primed and ready to paint
- Aluminum **Not Painted**

Fits: Arm Knuckle to Leveling Rod

Models: LF, LF+ & LFC+

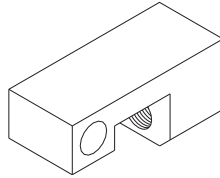

RPI Part #PCR699
OEM Part #006695 & 090412

LEVELING ROD & NUT

- See "FOR YOUR SAFETY" above.
- 5/16-24 x 17-3/8" long threaded rod with flange nut
- Stainless steel

Fits: Front Arm/Spring Guide Assembly

Models: LF, LF+ & LFC+

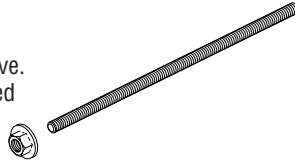

RPI Part #PCP663
OEM Part #006755

CONNECTOR HINGE PIN

- See "FOR YOUR SAFETY" above.
- 5/16" dia. x 1-5/16" long
- Stainless steel

Fits: Front Arm Assembly

Models: LF, LF+ & LFC+

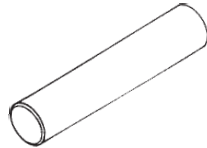

RPI Part #PCK690
OEM Part #N/A

SPRING ARM SPRING & GUIDE KIT

- See "FOR YOUR SAFETY" above.
- Includes Spring, Leveling Rod and Nut (RPI Part #PCR699), Main Arm Spring Safety Pin (PCP691), (2) Knuckle & Rod Connector (RPI Part #PCC646), and (2) Connector Hinge Pin (RPI Part #PCP663)

Fits: Front Arm Assembly

Models: LF, LF+ & LFC+

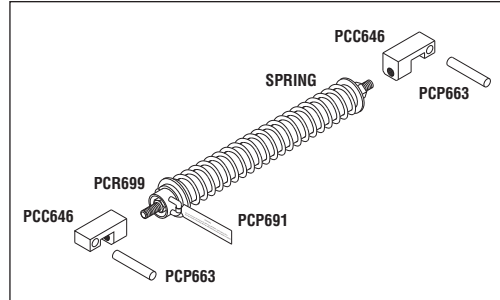

RPI Part #PCA692
OEM Part #007327

WIRE RETAINER ASSEMBLY

- See "FOR YOUR SAFETY" above.
- Includes (2) brass wire retainer, (2) 5' long #18 AWG wire, and (2) 8" long clear tubing

Fits: Main Arm Spring Assembly

Models: All LF, LF+ & LFC+

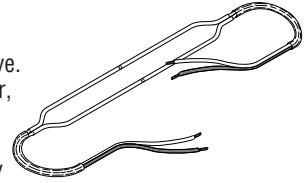

RPI Part #PCP662
OEM Part #006756

See "FOR YOUR SAFETY" above.

ARM HINGE PIN

- Includes: (2) RPI Part #RPH255 and (2) RPI Part #RPH107
- 5/16" dia. x 1-5/8" long
- Stainless steel

Fits: Front Arm Assembly

Models: LF, LF+ & LFC+

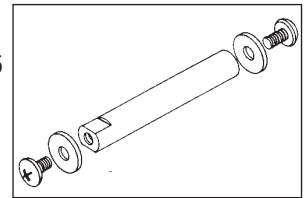

READ THIS BEFORE ORDERING DRIFT KIT (RPI PART #PCK651) TO SERVICE THE LF, LF+ or LFC+

The RPI Drift Kit (RPI Part #PCK651) can **only** be used with the redesigned RPI Arm Knuckle (RPI Part #PCK645).

RPI Part #PCK645
OEM Part #007037

ARM KNUCKLE

- See Drift Kit (RPI Part #PCK651)
- Part is primed and ready to paint
- Aluminum **Not Painted**
- Use in front or rear position

Fits: Front Arm Assembly

Models: LF, LF+ & LFC+

REDESIGNED TO ELIMINATE DRIFT
when used with RPI Drift Kit (RPI Part #PCK651)

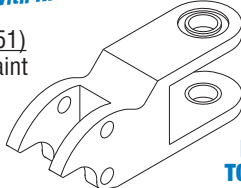

READY TO PAINT!

RPI Part #PCK651
OEM Part #N/A

DRIFT KIT

- For use **only** with the redesigned RPI Arm Knuckle (RPI Part #PCK645)
- Includes snubbing pin, wave washer and flat washer
- Use to eliminate drift in light

Fits: Arm Knuckle to Leveling Rod

Models: LF, LF+ & LFC+

ELIMINATE DRIFT!
For use **ONLY** with the RPI redesigned Arm Knuckle (RPI Part #PCK645)

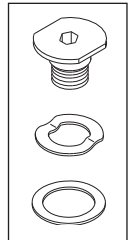

**RPI Part #PCA644
OEM Part #007038**

ARM ADAPTER

- Part is primed and ready to paint
 - Aluminum (**Not Painted**)
 - Includes arm adapter, and (2) set screw (RPI Part #RPH201)
- Fits:** Rear Arm to Arm Knuckle
Models: LF & LF+

READY TO PAINT!

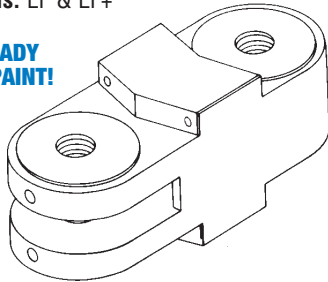

**NEW RPI Part #RPH201
OLD RPI Part #PCS666
OEM Part #090251**

SOCKET HEAD SET SCREW

- 50 per package
 - #8-32 x 1/4" lg.
 - Black alloy
 - Also in Socket Head Set Screw Kit (RPI Part #RPK418)
- Fits:** Adaptor Arm (RPI Part #PCA644)
Models: LF & LF+



**RPI Part #PCB616
Old OEM Part #H32-104**

BUSHING YOKE

- 2 per package
 - Stainless steel
- Fits:** Head and yoke assembly
Model: All LF & LFT+

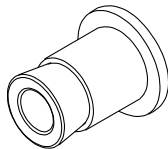

**RPI Part #RPH192
OEM Part # (None)**

SOCKET HEAD SCREW

- 50 per package
 - #6-32 x 3/8" lg.
 - Stainless steel
- Fits:** Yoke to bushing
Model: All LF & LFT+



**RPI Part #PCB617
OEM Part #006914**

STUD - HEAD BUSHING

- 2 per package
 - Stainless steel
- Fits:** Head and yoke assembly
Model: All LF & LFT+

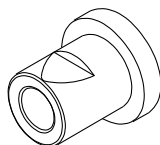

**RPI Part #PCS659
OEM Part #006704**

COUNTER BALANCE SPRING

- 2 per package
 - 2.575" lg. x .360" OD
 - Stainless steel
- Fits:** Front Arm Assembly
Models: LF & LF+

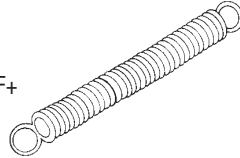

**RPI Part #PCC664
OEM Part #006767**

COUNTER BALANCE SPRING COVER

- 2 per package
 - Steel, zinc plated (**Not Painted**)
 - Used to cover Counter Balance Spring
- Models:** LF & LF+

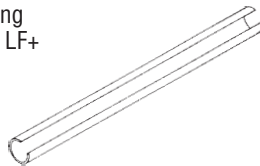

**RPI Part #PCI661
OEM Part #006687**

COUNTER BALANCE SPRING COVER INSERT

- 4 per package
 - Gray rubber
- Fits:** Counter Balance Spring Cover
Models: LF & LF+

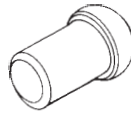

**RPI Part #PCR673
OEM Part #006747**

COUNTER BALANCE SPRING RETAINER

- Stainless steel
 - Includes counter balance spring retainer, and (2) #8-32 x 1/4" lg. Phillips head screw
 - Use Socket Head Screw (RPI Part #RPH198) to mount retainer
- Fits:** Rear Arm Knuckle
Models: All LF & LF+

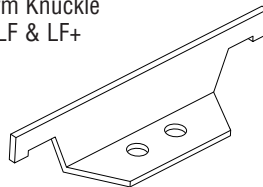

**RPI Part #RPH234
OEM Part #3325284**

BALANCE RETAINER SCREW

- 12 per package
 - #8-32 x 1/4 lg. Round Head Phillips
 - 18-8 Stainless steel
- Fits:** Counter Balance Spring Retainer (RPI Part #PCR673)
Models: All LF & LF+



**RPI Part #PCK660
OEM Part #006769**

SPRING RETAINER WITH WASHER

- 2 per package
 - Stainless steel
- Fits:** Counter Balance Spring/Front Arm
Models: LF & LF+

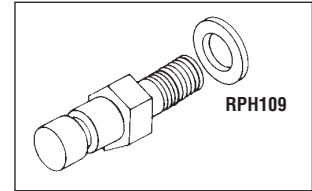

**RPI Part #RPH233
OEM Part #3324151**

FRONT ARM COVER SCREW

- 12 per package
 - #10-32 x 3/8" lg. Round Head Phillips
 - 18-8 Stainless steel
- Fits:** Front Arm Cover
Models: All LF & LF+ Series

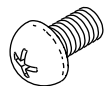

**RPI Part #PCS689
OEM Part #006700**

FOCUS SPRING

- 2 per package
- Fits:** Focus Bracket on Head Assembly
Models: LF & LF+

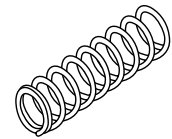

**RPI Part #PCS658
OEM Part #007031**

KNUCKLE HINGE SCREW

- 2 per package
 - 7/16-20
 - 3/16 hex socket
 - Stainless steel
- Fits:** Arm Knuckle
Models: LF, LF+ & LFC



**RPI Part #PCW665
OEM Part #006702**

KNUCKLE WASHER

- 12 per package
 - Nylon® (white)
 - 9/16 ID x 1" OD x .020 thk
- Fits:** Arm Knuckle & Arm Adapter
Models: LF, LF+ & LFC



**RPI Part #PCS675
OEM Part #3322968**

SPACER

- 12 per package
 - Nylon® (white)
 - .257" ID x .500" OD x .031" thk
- Fits:** Front Arm Assembly
Models: All LF & LF+



Dental Equipment

Models: LF & LF+ Series *(continued)*

RPI Part #PCS681
New OEM Part #3321820
Old OEM Part #013553

DIMMER SWITCH

- 3 position
- 15 AMP, 125 VAC, 1/2 H.P.
- 1/2" hole mount
- On some lights, it may be necessary to increase the size of the mounting hole to accommodate this switch

Fits: Rear Arm

Models: LF, LF+ & LFC

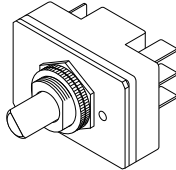

RPI Part #BUK042
New OEM Part #3322646
Old OEM Part #015408

DIMMER KNOB

Fits: Dimmer Switch

Models: LF, LF+ & LFC



RPI Part #PCT621
New OEM Part #3321846
Old OEM Part #015768

TRANSFORMER

- Primary=120V, 60 Hz. tap;
- Secondary=Com. 19V, 21V, 23V, 25V, 6A

Fits: Rear Arm

Models: LF, LF+ & LFC+

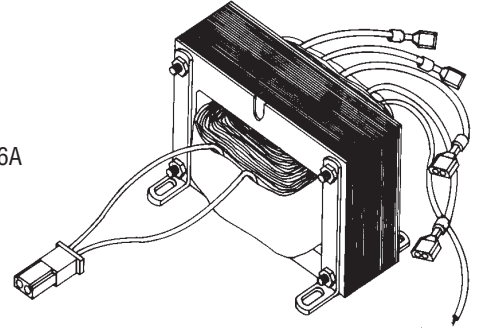

RPI Part #RPC274
OEM Part #016392

POWER CORD

- 13 A @ 125 VAC
- Length: 6 feet
- Color: Black
- Type: 16/3 SPT-2
- Plug NEMA 5-15P
- Flat-style cord

Models: LF & LF+ post mounted units only

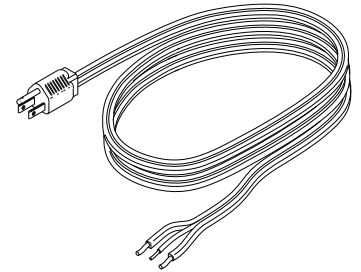

RPI Part #PCT622
OEM Part #015892

TRANSFORMER

- Primary=120V, 60 Hz. tap.;
- Secondary=0V, 25V, 27V, 6A

Fits: Rear Arm

Models: LFT+ & LFIT-D

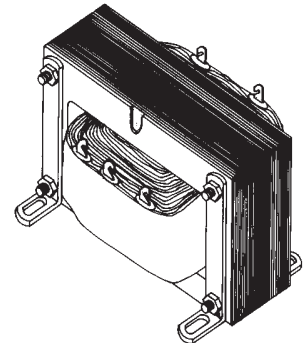

NOTES: _____

RPI Part #PCL606
OEM Part #3321879 & 017133

LAMP

- 25VAC, 150W; Halogen
- Base: Double ended
- Also available: Light Socket (RPI Part #PCS607)

Models: All LFII, LFIII, LFIIIS & LFIIISE

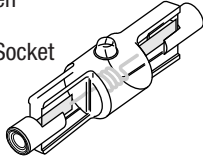

RPI Part #PCS607
OEM Part #3336992 & 015208

LIGHT SOCKET

- Also available: Lamp (RPI Part #PCL606)

Fits: Socket Holder

Models: All LFII, LFIII, LFIIIS & LFIIISE

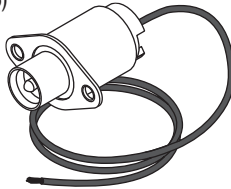

RPI Part #CAG035
OEM Part #017187

COVER GASKET

- Black neoprene sponge
- 1/4" dia. x 36" lg.
- Retains light socket wiring

Fits: Light Head, Yoke Groove

Models: All LFII, LFIII, LFIIIS & LFIIISE



RPI Part #PCB623
OEM Part #014901 (1 per pkg.) & 023940 (2 per pkg.)

REFLECTOR PIVOT BUSHING KIT

- 2 per package
- Plastic

Fits: Yoke to Yoke Cover

Models: All LFII, LFIII, LFIIIS & LFIIISE

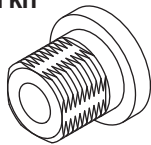

RPI Part #RPH203
OEM Part #090959

SOCKET HEAD SET SCREW

- 50 per package
- Material: Black oxide steel
- Size: #8-32 x 3/8" lg.
- Also available: Socket Head Set Screw Kit (RPI Part #RPK418)

Fits: Head Assembly

Models: All LFII

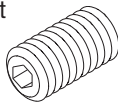

RPI Part #RPH197
OEM Part #090245

SOCKET HEAD SET SCREW

- 50 per package
- Material: Black oxide steel
- Size: #6-32 x 5/16" lg.
- Also available: Socket Head Set Screw Kit (RPI Part #RPK418)

Fits: Head Assembly

Models: All LFII



RPI Part #PCA805
OEM Part #33 21 838



HANDLE ASSEMBLY

- Material: Off White ABS
- Snaps onto Light Head and is easily removable

Fits: Light Head Assembly

Models: All models of LFII & LFIII

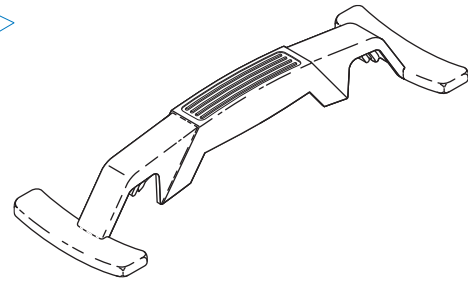

RPI Part #PCR710
OEM Part #3321887 & HB3-014062

REFLECTOR WITH LENS SPLASH SHIELD

- **NEW - Not Re-coated**
- Includes all parts as shown

Fits: Light Head

Models: All LFII

FREE
LENS SPLASH SHIELD & CUSHION KIT
WITH PURCHASE OF REFLECTOR!

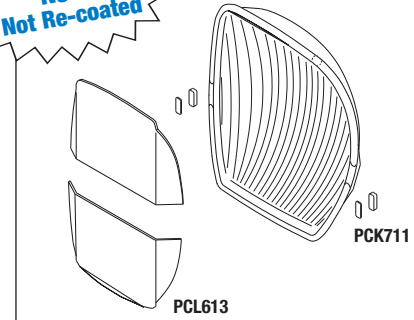

RPI Part #PCL613
OEM Part #3321598 & 015310

LENS SPLASH SHIELD

- Includes: upper shield, and lower shield
- Lexan® protective shield
- Also included in: Reflector With Splash Shield (RPI Part #PCR710)

Fits: Lens Assembly

Models: All LFII, LFIII, LFIIIS & LFIIISE

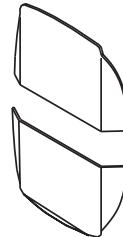

RPI Part #PCK711
OEM Part #015458 (Pad Only) & 015899 (Cushion Only)

CUSHION KIT

- Includes: (2 pcs) Pressure Pad and (2 pcs) Reflector Cushion
- Also included in: Reflector With Splash Shield (RPI Part #PCR710)

Fits: Light Head

Models: All LFII, LFIII & LFIIISE

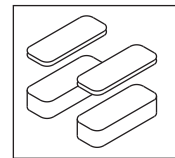

RPI Part #PCA683
OEM Part #014707

RELEASE PIN ASSEMBLY

- Material: Nickel plated brass
- Includes all parts as shown

Fits: Head Assembly

Models: All LFII, LFIII, LFIIIS & LFIIISE

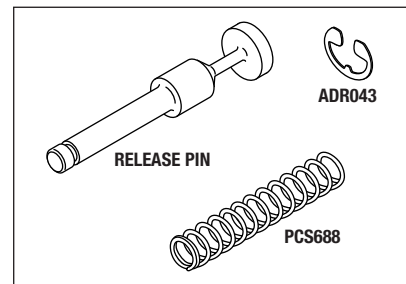

RPI Part #PCP684
OEM Part #026471

HINGE PIN

- Material: Stainless steel
- Includes all parts as shown
- This Hinge Pin *replaces* the OEM's Spacers and Screws

Fits: Head Assembly

Models: All LFII, LFIII, LFIIIS & LFIIISE

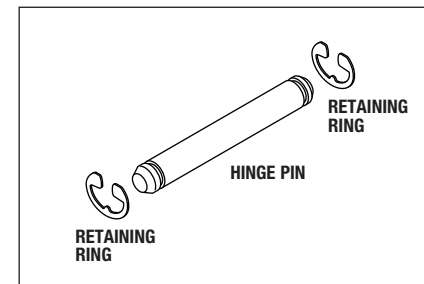

Dental Equipment

Model: LFI & LFIII Series (continued)

RPI Part #PCS604
OEM Part #3321853 & 007096

POWER SWITCH

- 15A@125VAC: SPST
- Toggle with 1-1/2" lg. bat handle and mounting hardware
- Includes all parts as shown
- Also included in: Sensor Conversion Kit (RPI Part #PCK803)

Fits: Switch Plate
Models: All LFI

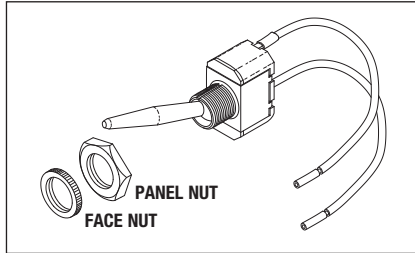

RPI Part #PCS804
OEM Part #014R379

SWITCH (INTENSITY)

- 6A @ 125VAC; SPDT; On/Off/On
- Includes all parts as shown

Fits: Yoke Assembly

Models: LFIII, LFIIC, LFIICB, LFIIC-D, LFIIS, LFIISE, LFIIT, LFIIT-D & LFIIW

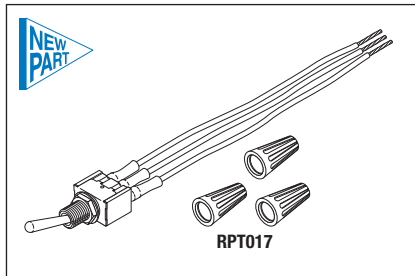

RPI Part #PCK803
OEM Part #051077 (Silver) & 054866LG (Grey)

SENSOR CONVERSION KIT

- Converts LFIII Touchless Sensor (OEM Part #052157) to manually operated On/Off
- 15A @ 125VAC; SPST
- Toggle with 1-1/2" lg Bat Handle
- Includes all parts as shown

Fits: Yoke assembly

Models: LFIII, LFIIC, LFIICB, LFIIC-D, LFIIL, LFIIT, LFIIT-D, LFIIW & LFIIW-D

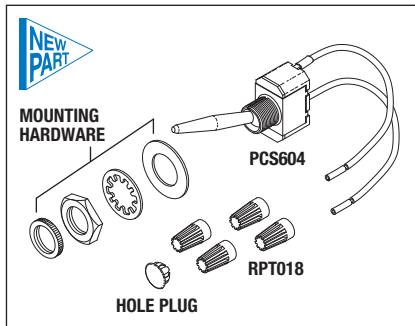

RPI Part #PCA680
OEM Part #001072



DIMMER SWITCH ASSEMBLY

- Includes: Knob (RPI Part #BUK042)
- Fits:** Post Knuckle Assembly
Models: LFIIT, LFIIT-D, LFIIT & LFIIT-D

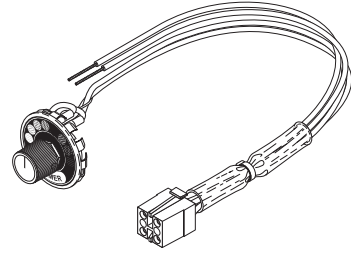

RPI Part #PCS681
OEM Part #3321820 & 013553

DIMMER SWITCH

- 3 position
- 15AMP @ 125VAC
- 1/2" bushing mount
- 1/4" tabs
- Includes: mounting hardware

Fits: Rear Arm

Models: LFI, LFIIC, LFIIC-D, LFIII, LFIIC, LFIIC-D & LFIICB

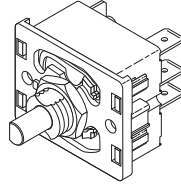

RPI Part #BUK042
OEM Part #33 22 646 & 015408

DIMMER/SENSITIVITY KNOB

- Shaft size: 1/4" dia.
- Also included in: Dimmer Switch Assembly (RPI Part #PCA680)

Fits: Dimmer Switch

Models: LFI, LFIIC, LFIIC-D, LFIIL, LFIIT, LFIIT-D, LFIIW, LFIIW (2), LFIIW (3), LFIIS, LFIIC, LFIICB, LFIIC-D, LFIIS, LFIISE, LFIIT, LFIIT-D & LFIIW

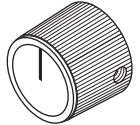

SERVICE TIP - If this is your first time servicing or replacing any or all of the following parts, it is recommended that you order or download from our website (www.rpiparts.com) a **FREE** copy of the "INSTRUCTIONS FOR THE REPLACEMENT OF GAS OR MECHANICAL SPRING" (RPI Part #PCA700INS) and the "RPI Exploded View of the LFI Lights" (RPI Part #EXP001). These handy work tools will assist you with your servicing or repairing of the equipment.

RPI Part #PCA698
OEM Part #001068



DIMMER CIRCUIT ASSEMBLY

- Includes: Insulator sheet
- Fits:** Column Assembly of Standard Trolley Assembly (OEM Part #001032) & Standard Dual Trolley Assembly (OEM Part #001319)

Models: LFIIT & LFIIT-D

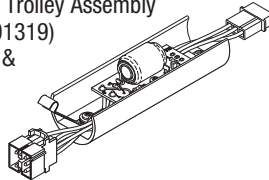

RPI Part #PCA794
OEM Part #045782



DIMMER CIRCUIT ASSEMBLY

- Includes: Insulator sheet
- Fits:** Column Assembly of Standard Trolley Assembly (OEM Part #001032) & Standard Dual Trolley Assembly (OEM Part #001319)

Models: LFIIT & LFIIT-D

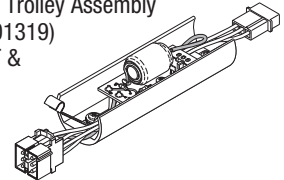

SERVICE TIP - Wire Harness Extensions (RPI Part #'s PCH798 and PCH799) can be connected to each other to accommodate various operatory ceiling heights.

RPI Part #PCH798
OEM Part #001295



WIRE HARNESS EXTENSION

- ~11" lg.
 - Also available: 23" long version Wire Harness Extension (RPI Part #PCH799)
- Fits:** Standard Trolley Assembly (OEM Part #001032), Standard Dual Trolley Assembly (OEM Part #001319)

Models: LFIIT, LFIIT-D, LFIIT, LFIIT-D

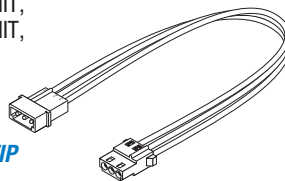

See **SERVICE TIP** above

RPI Part #PCH799
OEM Part #001298



WIRE HARNESS EXTENSION

- ~23" lg.
 - Also available: 11" long version Wire Harness Extension (RPI Part #PCH798)
- Fits:** Standard Trolley Assembly (OEM Part #001032), Standard Dual Trolley Assembly (OEM Part #001319)

Models: LFIIT, LFIIT-D, LFIIT, LFIIT-D

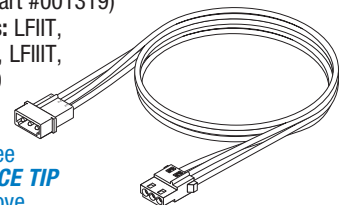

See **SERVICE TIP** above

SERVICE TIP

If this is your first time servicing or replacing any or all of the following parts, it is recommended that you order or download from our website (www.rpiparts.com) a **FREE** copy of the “**INSTRUCTIONS FOR THE REPLACEMENT OF GAS OR MECHANICAL SPRING**” (RPI Part #PCA700INS) and the “**RPI Exploded View of the LFIIL Lights**” (RPI Part #EXP001). These handy work tools will assist you with your servicing or repairing of the equipment.

RPI Part #PCK800
OEM Part #33 24 501

POST KNUCKLE ASSEMBLY

- Material: Aluminum **Not Painted**
- Part is primed and ready for paint
- Includes: Installed bushings
- Also available: Post Knuckle Hardware Kit (RPI Part #PCK807)

Fits: Rear Arm Adapter
Models: LFIIT, LFIIT-D, LFIIT & LFIIT-D

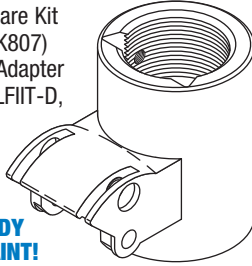

RPI Part #PCK807
OEM Part #33 24 105 (Wave Washer Only),
090959 (Set Screw Only), **33 24 154** (Screw Only)
& **30 05 001** (Spring Pin Only)

POST KNUCKLE HARDWARE KIT

- Includes all parts as shown
- Also available: Post Knuckle Assembly (RPI Part #PCK800)

Fits: Post Knuckle Assembly

Models: LFIIC, LFIIC-D, LFIIT, LFIIT-D, LFIIC, LFIIC-D, LFIIT & LFIIT-D

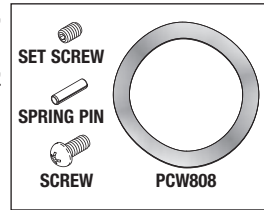

RPI Part #PCW808
OEM Part #33 24 105

WAVE WASHER

- 5 per package
- Material: Spring steel
- Size: 1.400" ID x 1.777" OD x .013" thk
- Also included in: Post Knuckle Hardware Kit (RPI Part #PCK807)
- Also available: Post Knuckle Assembly (RPI Part #PCK800)

Fits: Post Knuckle Assembly
Models: LFIIC, LFIIC-D, LFIIT, LFIIT-D, LFIIC, LFIIC-D, LFIIT & LFIIT-D

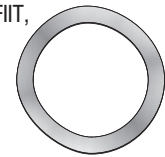

SERVICE TIP

If you are replacing the original **TROLLEY BRACKET ASSEMBLY** with RPI Part #PCA657 (pictured below), you must also replace the wire harness with RPI Part #PCW620 (pictured below). The connectors on the original assembly are obsolete and were replaced by a new style connector.

RPI Part #PCA657
OEM Part #001030

TROLLEY BRACKET ASSEMBLY

Fits: Trolley to Track Power Cord connection and Wire Harness (RPI Part #PCW620)

See **SERVICE TIP** above

Models: LFIIT, LFIIT-D, LFIIT & LFIIT-D

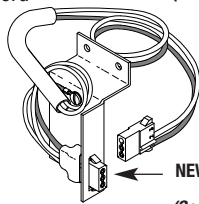

OBSOLETE CONNECTOR
(Male Pins)
(See **SERVICE TIP** above.)

NEW STYLE CONNECTOR
(Female Sockets)
(See **SERVICE TIP** above.)

RPI Part #PCW620
OEM Part #013721

WIRE HARNESS

- Plugs into Trolley Bracket Assembly

Fits: Track Trolley Power Cord Connection
See **SERVICE TIP** above

Models: LFIIT, LFIIT-D, LFIIL & LFIIL-D

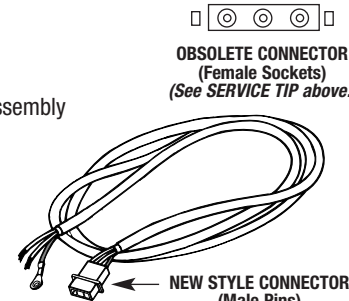

OBSOLETE CONNECTOR
(Female Sockets)
(See **SERVICE TIP** above.)

NEW STYLE CONNECTOR
(Male Pins)
(See **SERVICE TIP** above.)

RPI Part #PCA795
OEM Part #33 24 329

GUIDE PLATE ASSEMBLY

- Material: Zinc plated steel
- Each Trolley Assembly requires (2) Guide Plate Assemblies (RPI Part #PCA795)
- Includes: (2 pcs each) Dowel Pin (RPI Part #RPP750) and Roller (RPI Part #PCR796)

Fits: Standard Trolley Assembly (OEM Part #001032) & Standard Dual Trolley Assembly (OEM Part #001319)

Models: LFIIT, LFIIT-D, LFIIL & LFIIL-D

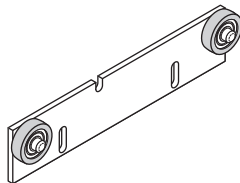

RPI Part #RPP750
OEM Part #001384

DOWEL PIN

- 2 per package
- Material: Alloy steel hardened
- Size: .250" dia. x .625" lg.
- Also included in: Guide Plate Assembly (RPI Part #PCA795)

Fits: Guide Plate Assembly, Standard Trolley Assembly (OEM Part #001032) & Standard Dual Trolley Assembly (OEM Part #001319)

Models: LFIIT, LFIIT-D, LFIIL, LFIIL-D

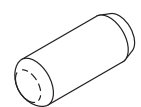

RPI Part #PCR796
OEM Part #33 24 451

ROLLER

- Material: Plastic outer sleeve over stainless steel ball bearing
- Size: .250" ID x .896" OD x .250" thk
- Also included in: Guide Plate Assembly (RPI Part #PCA795)

Fits: Guide Plate Assembly, Standard Trolley Assembly (OEM Part #001032) & Standard Dual Trolley Assembly (OEM Part #001319)

Models: LFIIT, LFIIT-D, LFIIL & LFIIL-D

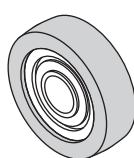

RPI Part #PCP797
OEM Part #33 24 345

SPIRAL PIN

- 10 per package
- Material: Zinc plated steel
- Size: .250" dia. x 1.00" lg.
- Also available: Roller (RPI Part #PCR796)

Fits: Standard Trolley Assembly (OEM Part #001032) & Standard Dual Trolley Assembly (OEM Part #001319)

Models: LFIIT, LFIIT-D, LFIIL & LFIIL-D

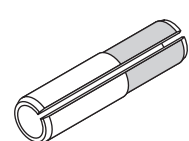

Dental Equipment

Models: LFII & LFIII Series (continued)

SERVICE TIP

If this is your first time servicing or replacing any or all of the following parts, it is recommended that you order or download from our website (www.rpiparts.com) a **FREE** copy of the "INSTRUCTIONS FOR THE REPLACEMENT OF GAS OR MECHANICAL SPRING" (RPI Part #PCA700INS) and the "RPI Exploded View of the LFII Lights" (RPI Part #EXP001). These handy work tools will assist you with your servicing or repairing of the equipment.

RPI Part #PCB667
OEM Part # (No OEM Part # Available)

TIE BARS

- 2 per package
- **Also included in: RPI Part #'s PCS647, PCS648, PCS649 & PCS650**
- Not used with RPI Part #'s PCS601 & PCS602

Fits: Front Arm Assembly
Models: All LFII, LFIII, LFIIIC, LFIIT, LFIIT-D, LFIIC-D & LFIICB

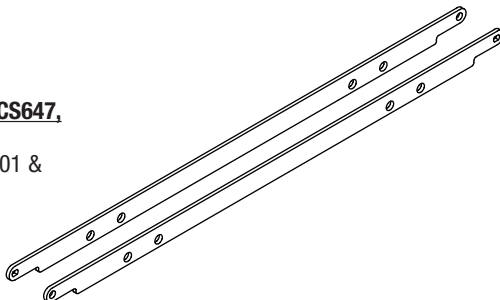

RPI Part #PCW603
OEM Part #015769

WIRE HARNESS ASSEMBLY

- 6 ft. lg.
 - Female sockets
- Fits:** Transformer to Adaptor
Models: All LFII, LFIII & LFIIC

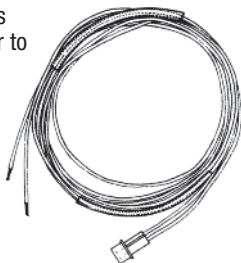

RPI Part #PCK668
OEM Part #015810

DROP KNUCKLE

- Material: Aluminum **Not Painted**
 - Part is primed and ready to paint
 - Includes: installed bushings
 - Includes all parts as shown
- Fits:** Drop Arm to Front Arm
Models: LFIIC, LFIIC-D, LFIIT, LFIIT-D, LFIIW(2), LFII, LFIIW, LFIIT-D, LFIIC & LFIIC-D

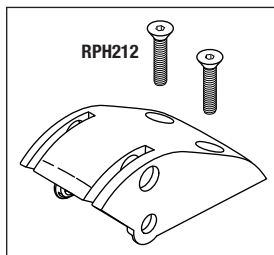

READY TO PAINT!

RPI Part #RPH212
OEM Part #33 24 170 & 090713

FLAT HEAD HEX SOCKET CAP SCREW

- 12 per package
 - Material: Black alloy steel
 - Size: #10-24 x 3/4" lg.
- Fits:** Drop Knuckle to Drop Down Arm
Models: LFIIC, LFIIC-D, LFIIT, LFIIT-D, LFIIW(2), LFIIC, LFIICB, LFIIC-D, LFIIT & LFIIT-D

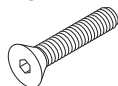

RPI Part #PCK669
New OEM Part #3325169
Old OEM Part #015809

STRAIGHT KNUCKLE

- Material: Aluminum **Not Painted**
 - Part is primed and ready to paint
 - Includes: installed bushings
 - Use in front or rear position
 - Also available: Drift Kit (RPI Part #PCK651)
- Fits:** Front Arm Assembly
Models: LFII, LFIIW(3), LFII, LFIIC, LFIIC-D, LFII, LFIIC & LFIIC-D

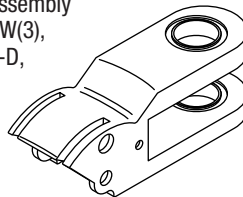

READY TO PAINT!

RPI Part #PCP678
OEM Part #3322976 & 025433

KNUCKLE PIVOT PIN

- 2 per package
 - Stainless steel
- Fits:** Front Arm Assembly
Models: All LFII, LFIII, LFIIC, LFIIT, LFIIT-D, LFIIC-D & LFIICB

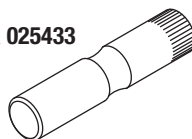

RPI Part #PCP677
OEM Part #3322604 & 015433

TIE BAR PIVOT PIN

- 2 per package
 - Stainless steel
- Fits:** Front Arm Assembly
Models: All LFII, LFIII, LFIIC, LFIIT, LFIIT-D, LFIIC-D & LFIICB

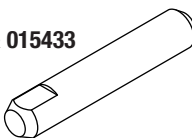

RPI Part #PCS675
OEM Part #3322968

SPACER

- 12 per package
 - Material: Nylon® (white)
 - Size: .257" ID x .500" OD x .031" THK
- Fits:** Front Arm Assembly
Models: All LFII & LFIII



RPI Part #PCS671
OEM Part #4191222

FRONT KNUCKLE SUPPORT

- Material: Aluminum
 - Includes: installed bushings
 - Includes all parts as shown
- Fits:** Front Arm Assembly
Models: All LFII, LFIII, LFIIC, LFIIT, LFIIT-D, LFIIC-D & LFIICB

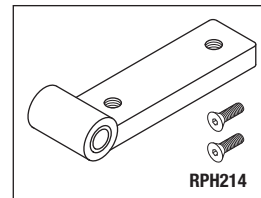

RPI Part #PCS672
OEM Part #015806

REAR KNUCKLE SUPPORT

- Material: Aluminum
 - Includes: installed bushings
 - Includes all parts as shown
 - Use the 5/8" socket head set screw (RPI Part #RPH211) for gas spring adjustment
- Fits:** Front Arm Assembly
Models: All LFII, LFIII, LFIIC, LFIIT, LFIIT-D, LFIIC-D & LFIICB

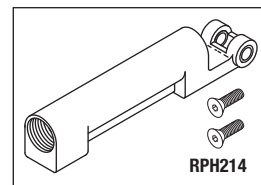

RPI Part #RPH214
OEM Part #3323115 & 090191

FLAT HEAD HEX SOCKET CAP SCREW

- 12 per package
 - Material: Black alloy steel
 - Size: #10-24 x 1/2" lg.
- Fits:** Front Support Knuckle (RPI Part #PCS671) & Rear Support Knuckle (RPI Part #PCS672)
Models: All LFII, LFIII, LFIIC, LFIIT, LFIIT-D, LFIIC-D & LFIICB



RPI Part #RPH211
OEM Part #090650

SOCKET HEAD SET SCREW

- Material: Black alloy steel
 - Size: 5/8-11 x 5/8" lg.
- Fits:** Rear Knuckle Support
Models: All LFII, LFIII, LFIIC, LFIIT, LFIIT-D, LFIIC-D & LFIICB



RPI Part #PCT621
OEM Part #3321846 & 015768

TRANSFORMER

- Primary=117V, 60 Hz.
- Secondary=Com. 19V, 21V, 23V, 25V @ 6A

Fits: Rear Arm

Models: LFII, LFIIIC, LFIIIC-D, LFIIIL, LFII(2), LFIIW(3) & LFIIC

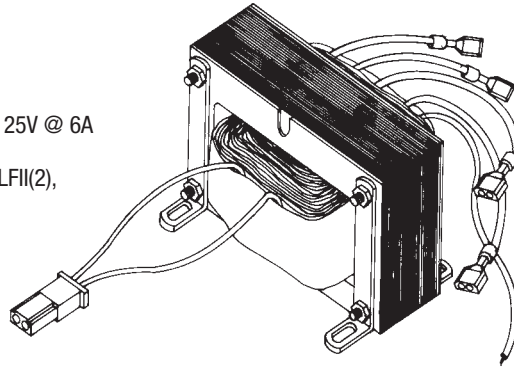

RPI Part #RPC274
OEM Part #016392

INDUSTRIAL GRADE POWER CORD

- Color: Black
 - Length: 6 ft.
 - 16/3 SPT-2, 105°C; 13A @ 125 VAC
 - Plug Type: NEMA 5-15P
 - Connector Type: None; 0.158" x 0.380" Flat cord
- Models:** LFII & LFIII post mounted lights only

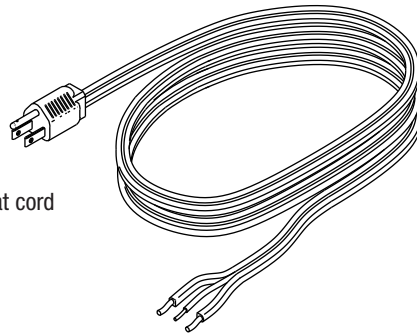

RPI Part #PCT622
OEM Part #015892

TRANSFORMER

- Primary=117V, 60 Hz.
- Secondary=0V, 25V, 27V @ 6A

Fits: Rear Arm

Models: LFIIT, LFIIT-D, LFIIT-D & LFIICB

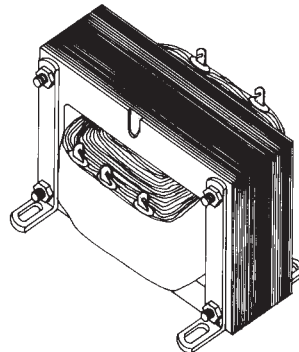

RPI Part #PCC801
OEM Part #33 35 275

BEARING CAP

- Material: Aluminum **Not Painted**
- Part is primed and ready to paint
- Also available: Flat Head Hex Socket Cap Screw (RPI Part #RPH212)

Fits: Drop Down Arm

Models: LFIIC, LFIIC-D, LFIIT, LFIIT-D, LFIIW, LFIIC, LFIIC-D, LFIIT, LFIIT-D & LFIIW

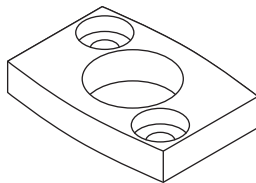

READY TO PAINT!

RPI Part #RPH212
OEM Part #33 24 170 & 090713

FLAT HEAD HEX SOCKET CAP SCREW

- 12 per package
- Material: Black alloy steel
- Size: #10-24 x 3/4" lg.

Fits: Drop Knuckle to Drop Down Arm

Models: LFIIC, LFIIC-D, LFIIT, LFIIT-D, LFIIW(2), LFIIC, LFIICB, LFIIC-D, LFIIT & LFIIT-D

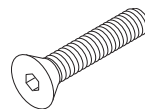

RPI Part #PCR694
OEM Part #015186

PIVOT ROD

- Material: Zinc plated steel
- Fits:** Down/Drop Arm and Yoke Assembly

Models: LFIIC, LFIIC-D, LFIIT, LFIIT-D, LFIIW(2), LFIIC, LFIICB, LFIIT & LFIIT-D

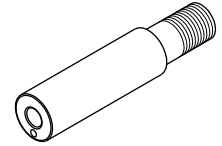

RPI Part #RPP093
OEM Part #007466

SPRING (ROLL) PIN

- 12 per package
- Material: Zinc plated steel
- Size: 1/8" dia. x 3/4" lg.

Fits: Drop Arm & Pivot Rod

Models: LFIIC, LFIIC-D, LFIIT, LFIIT-D, LFIIW(2), LFIIC, LFIICB, LFIIT & LFIIT-D

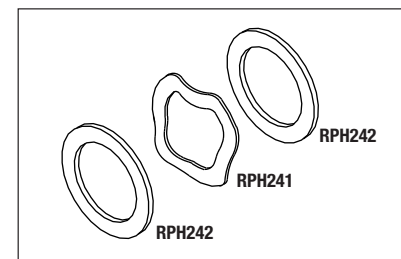
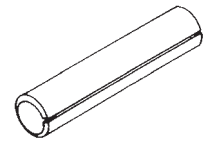

RPI Part #PCK693
OEM Part # (No OEM Part # Available)

WAVE WASHER KIT

- Includes all parts as shown
- Fits:** Pivot Rod to Yoke Assembly
- Models:** LFIIC, LFIIC-D, LFIIT, LFIIT-D, LFIIW(2), LFIIC, LFIICB, LFIIT & LFIIT-D

RPI Part #RPH241
OEM Part #015502

WAVE WASHER

- 5 per package
- Size: .640" ID x .875" OD x .008" thk
- Also included in: Wave Washer Kit (RPI Part #PCK693)

Models: LFIIC, LFIIC-D, LFIIT, LFIIT-D, LFIIW(2), LFIIC, LFIICB, LFIIT & LFIIT-D



RPI Part #RPH242
OEM Part #3323016

FLAT WASHER

- 5 per package
- Size: .640" ID x .875" OD x .035" thk
- Also included in: Wave Washer Kit (RPI Part #PCK693)

Models: LFIIC, LFIIC-D, LFIIT, LFIIT-D, LFIIW(2), LFIIC, LFIICB, LFIIT & LFIIT-D

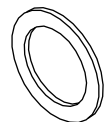

Dental Equipment

Models: LFII & LFIII Series (continued)

RPI Part #PCI806
OEM Part #0460300DW, 0446300LG & 46300PWT



INSULATOR

- Material: White plastic
- Includes all parts as shown
- Fits:** Metal handle to Yoke
- Models:** LFIII, LFIIIC, LFIIICB, LFIIIC-D, LFIIIS, LFIIISE, LFIIIT, LFIIIT-D & LFIIWL

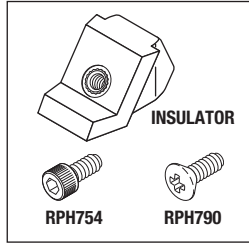

RPI Part #PCI652
OEM Part #015565

INSULATOR

- Material: Black plastic
- Includes all parts as shown
- Fits:** Metal Handle to Yoke
- Model:** LFII

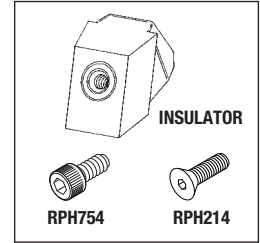

RPI Part #RPH754
OEM Part #94 41 403



SCREW (#10-24 x .375 lg)

- 25 per package
- Material: Stainless steel
- Size: #10-24 x .375" lg. Socket Head Cap Screw
- Also Included in: Insulator (RPI Part #PCI806)
- Fits:** Insulator
- Models:** LFIII, LFIIIC, LFIIICB, LFIIIC-D, LFIIIS, LFIIISE, LFIIIT, LFIIIT-D & LFIIWL

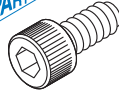

RPI Part #RPH790
OEM Part #33 23 115



SCREW (#10-24 x .500 lg)

- 25 per package
- Material: Stainless Steel
- Size: #10-24 x .500" lg. Oval Head Phillips
- Also Included in: Insulator (RPI Part #PCI806) and Insulator (RPI Part #PCI652)
- Fits:** Insulator
- Models:** LFII, LFIIIC, LFIIIC-D, LFIIIL, LFIIIT, LFIIIT-D, LFIIW, LFIIW (2), LFIIW (3), LFIIII, LFIIIC, LFIIICB, LFIIIC-D, LFIIIS, LFIIISE, LFIIIT, LFIIIT-D & LFIIWL

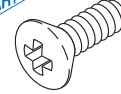

RPI Part #RPH214
OEM Part #3323115 & 090191

FLAT HEAD HEX SOCKET CAP SCREW

- 12 per package
- Material: Black alloy steel
- Size: #10-24 x .500" lg.
- Also Included in: Insulator (RPI Part #PCI652)
- Fits:** Insulator, Front Arm Assembly and Rear Arm
- Models:** LFII, LFIIIL, LFIIW(3), LFIIIC, LFIIIT, LFIIICB & LFIIIT-D

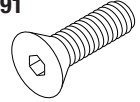

RPI Part #PCA670
OEM Part #3322620 & 014530

ARM ADAPTER

- Material: Aluminum **Not Painted**
- Part is primed and ready to paint
- Includes: Arm Adapter and (2 pcs) Set Screw (RPI Part #RPH208)
- Also available: Drift Kit (RPI Part #PCK651)
- Fits:** Rear Arm to Straight Knuckle (RPI Part #PCK669)
- Models:** LFII, LFIIIC, LFIIIC-D, LFIIII & LFIIIC

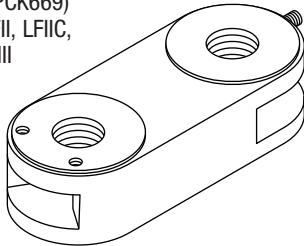

READY TO PAINT!

RPI Part #RPH208
OEM Part #3323123 & 090645

SOCKET HEAD SET SCREW

- 50 per package
- Material: Black alloy steel
- Size: #10-32 x .500" lg.
- Also included in: Arm Adapter (RPI Part #PCA670) & Socket Head Set Screw Kit (RPI Part #RPK118)
- Fits:** Arm Adapter (RPI Part #PCA670)
- Models:** LFII, LFIIIC, LFIIIC-D & LFIIII, LFIIIC

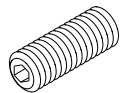

RPI Part #PCS697
OEM Part #3323073 & 026597

KNUCKLE HINGE SCREW

- 2 per package
- Material: Stainless steel
- 7/16-20
- Fits:** Arm adapter and knuckle
- Models:** LFII, LFIIIC, LFIIIC-D, LFIIII & LFIIIC

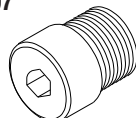

RPI Part #PCK651
OEM Part #006804 (Kit), 016188 & 33.22.992 (Snubbing Pin), 016189 & 33.23.016 (Flat Washer), 017186 & 33.23.008 (Wave Washer)

DRIFT KIT

- Material: Stainless steel
- Includes all parts as shown
- For stabilizing side to side drift
- Also available: Arm Adapter (RPI Part #PCA670) and Straight Knuckle (RPI Part #PCK669)
- Fits:** Arm Adapter and Straight Knuckle
- Models:** LFII, LFIIIC, LFIIW(2), LFIIIC-D, LFIIII, LFIIIC & LFIIIC-D

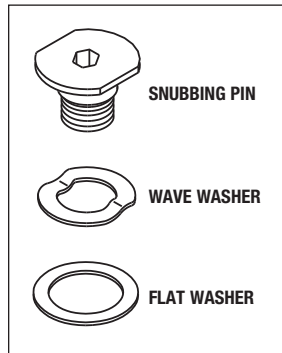

RPI Part #RPA032
OEM Part # (No OEM Part # Available)

THREADLOCKER 242

- .02 fl. oz. (.5 ml)
- Removable adhesive by Loctite®
- Prevents rust and corrosion



RPI Part #PCS686
OEM Part #015597

LAMP REMOVAL SPRING

- 2 per package
- Material: Stainless steel
- Size: .240" OD x .588" lg. x .033" dia. wire
- Fits:** Head Assembly
- Models:** All LFII, LFIIII, LFIIIS & LFIIISE

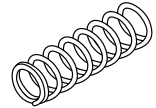

RPI Part #PCS687
OEM Part #015160

FOCUS SPRING

- 2 per package
- Material: Stainless steel
- Size: .300" OD x .570" lg. x .038" dia. wire
- Fits:** Head Assembly
- Models:** All LFII, LFIIII, LFIIIS & LFIIISE

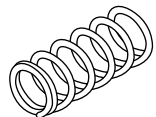

RPI Part #PCS688
OEM Part #015505

RELEASE SPRING

- 2 per package
- Material: Stainless steel
- Size: .182" OD x 1.000" lg. x .016" dia. wire
- Also included in Release Pin Assembly (RPI Part #PCA683)
- Fits:** Head Assembly
- Models:** All LFII, LFIIII, LFIIIS & LFIIISE

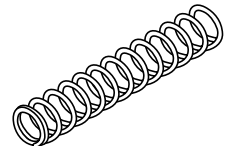

RPI Part #PCT615
OEM Part #016749

SPRING TOOL

- For Gas and Mechanical spring adjustment
- Material: Nickel plated steel
- Size: ~10" lg. x 3-1/4"
- 5/16" hex

Fits: Rear Support Knuckle

Models: ALL LFII & LFIII Series

LOOK!
The RPI Spring Tool has markings right on the tool itself to help you make the correct adjustments to Gas Springs.

This marking indicates the point to STOP when making adjustments to Unit Lights.

This marking indicates the point to STOP when making adjustments to Ceiling Lights.



Service Tip
When making adjustments to Gas Springs only -The RPI Spring Tool has special markings right on the tool itself to help you make tension adjustments to the Gas Springs. These markings indicate the maximum distance you should insert and turn the Spring Tool. Using these markings when making adjustments can help you avoid a potential jam. In addition, if you reach these markings and the Gas Springs do not respond, then the Gas Springs must be replaced. **(Important: These markings are not intended for use with Mechanical Springs.)**

RPI Part #PCA700
OEM Part #9439738

MECHANICAL SPRING (UNIT MOUNT)

- Includes all parts as shown
 - Color of spring is white
- Fits:** Lights with Yoke to Straight Knuckle
Models: LFII, LFLII, LFIW(3) & LFIII

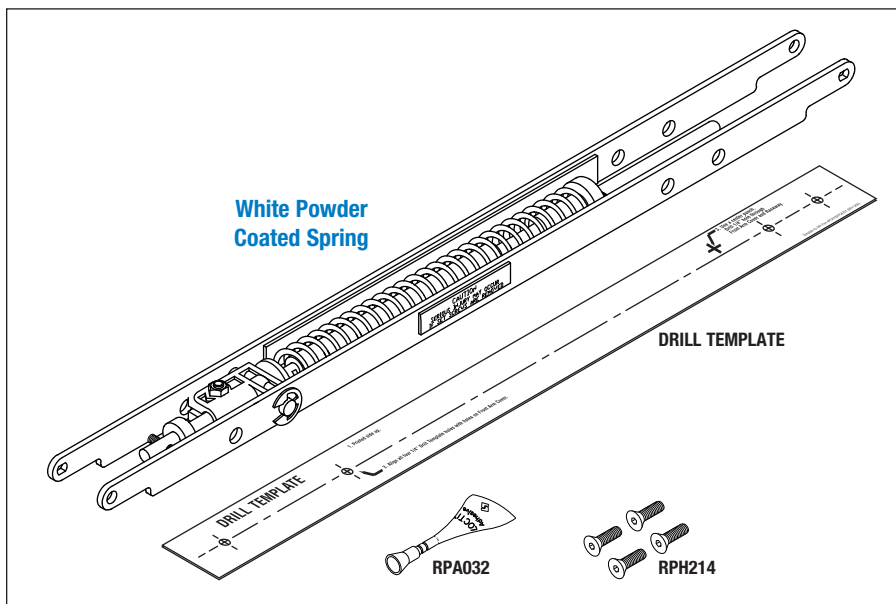

RPI Part #PCA701
OEM Part #1532907

MECHANICAL SPRING (CEILING MOUNT)

- Includes all parts as shown
 - Color of spring is red
- Fits:** Lights with Yoke to Drop Arm
Models: LFIIC, LFIIC-D, LFIIT, LFIIT-D, LFIW(2), LFIIC, LFIIT, LFIIC-D, LFIIT-D & LFIICB

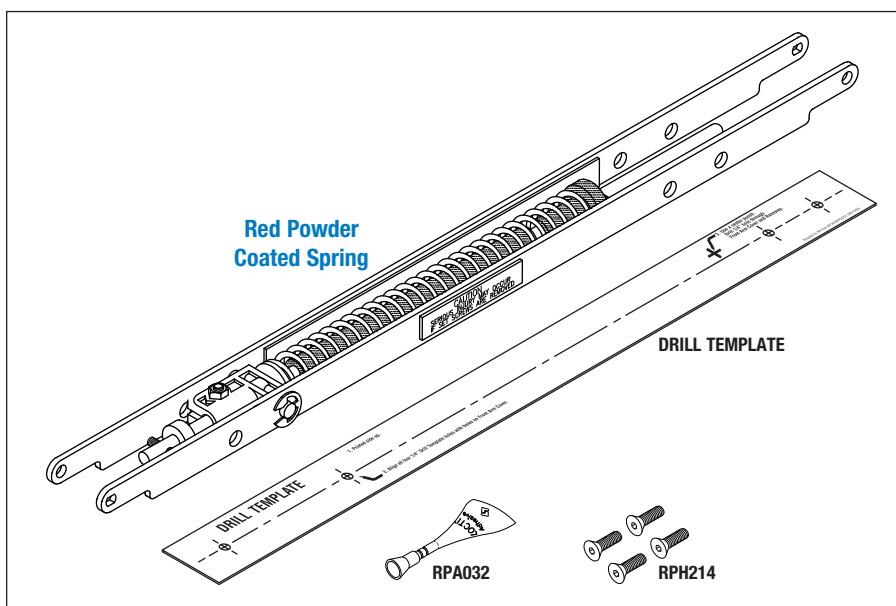

Dental Equipment

Models: LFII & LFIII Series (continued)

RPI Part #PCS601
OEM Part #014140

**GAS SPRING WITH ANCHOR
(CEILING OR TRACK MOUNT)**

- 190 lbs.
- Includes all parts as shown

Fits: Front Arm

Models: LFIIIC, LFIIIC-D, LFIIIT, LFIIIT-D & LFIIW(2)

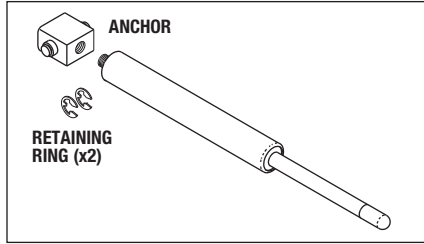

RPI Part #PCS602
OEM Part #017185

**GAS SPRING WITH ANCHOR
(UNIT MOUNT)**

- 170 lbs.
- Includes all parts as shown

Fits: Front Arm

Models: LFII, LFLII & LFWII (3)



SERVICE TIP

If you do not know for certain that the gas spring you are replacing **exactly** matches the RPI Part #PCS601 or PCS602, then – to save time and to be on the safe side – order the appropriate Gas Spring Assembly: RPI Part #PCA653, PCA654, PCA655 or PCA656.

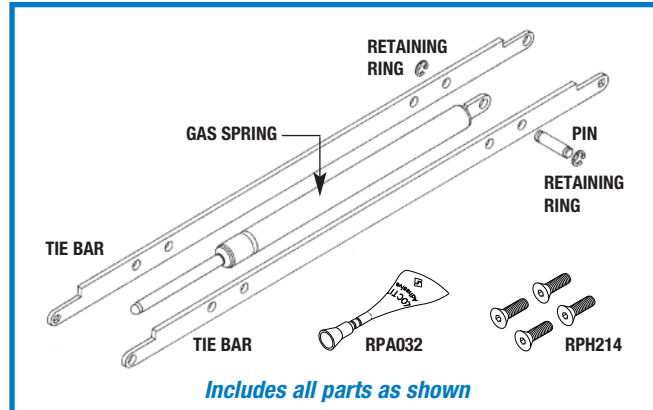

RPI Part #PCA655
OEM Part #026480

CEILING OR TRACK • 195 LBS.

GAS SPRING ASSEMBLY (CEILING OR TRACK)

- 195 lbs.
- Includes: Gas Spring (Ceiling or Track) (RPI Part #PCS649)

Fits: Front Arm with **plastic** handles

Models: LFIIIC, LFIIIC-D, LFIIIT, LFIIIT-D & LFIIW(2)

RPI Part #PCA656
OEM Part #026481

CEILING OR TRACK • 210 LBS.

GAS SPRING ASSEMBLY (CEILING OR TRACK)

- 210 lbs.
- Includes: Gas Spring (Ceiling or Track) (RPI Part #PCS650)

Fits: Front Arm with **metal** handles

Models: LFIIIC, LFIIIC-D, LFIIIT, LFIIIT-D & LFIIW(2)

RPI Part #PCA653
OEM Part #026478

UNIT MOUNT • 175 LBS.

GAS SPRING ASSEMBLY (UNIT MOUNT)

- 175 lbs.
- Includes: Gas Spring (Unit Mount) (RPI Part #PCS647)

Fits: Front Arm with **plastic** handles

Models: LFII, LFIIL & LFIW(3)

RPI Part #PCA654
OEM Part #026479

UNIT MOUNT • 185 LBS.

GAS SPRING ASSEMBLY (UNIT MOUNT)

- 185 lbs.
- Includes: Gas Spring (Unit Mount) (RPI Part #PCS648)

Fits: Front Arm with **metal** handles

Models: LFII, LFIIL & LFIW(3)

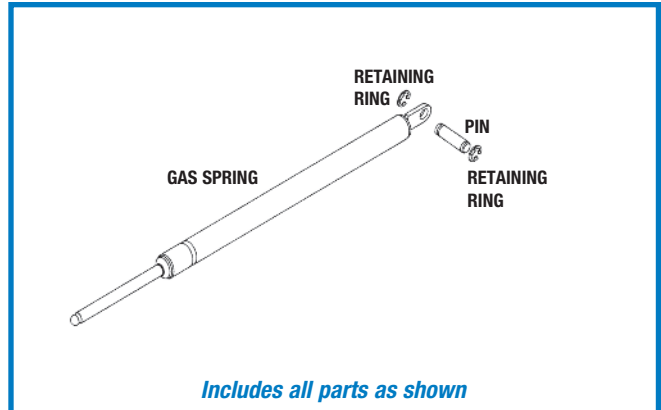

RPI Part #PCS649
OEM Part #023646

CEILING OR TRACK • 195 LBS.

GAS SPRING (CEILING OR TRACK)

- 195 lbs.
- Replacement for Gas Spring Assembly (RPI Part #PCA655)

Fits: Front Arm with **plastic** handles

Models: LFIIIC, LFIIIC-D, LFIIIT, LFIIIT-D & LFII(2)

RPI Part #PCS650
OEM Part #023647

CEILING OR TRACK • 210 LBS.

GAS SPRING (CEILING OR TRACK)

- 210 lbs.
- Replacement for Gas Spring Assembly (RPI Part #PCA656)

Fits: Front Arm with **metal** handles

Models: LFIIIC, LFIIIC-D, LFIIIT, LFIIIT-D & LFIIW(2)

RPI Part #PCS647
OEM Part #023644

UNIT MOUNT • 175 LBS.

GAS SPRING (UNIT MOUNT)

- 175 lbs.
- Replacement for Gas Spring Assembly (RPI Part #PCA653)

Fits: Front Arm with **plastic** handles

Models: LFII, LFIIL & LFIW(3)

RPI Part #PCS648
OEM Part #023645

UNIT MOUNT • 185 LBS.

GAS SPRING (UNIT MOUNT)

- 185 lbs.
- Replacement for Gas Spring Assembly (RPI Part #PCA654)

Fits: Front Arm with **metal** handles

Models: LFII, LFIIL & LFIW(3)

RPI Part #EMB001
OEM Part # (None)

BRUSH

- 2 per package
 - Size: 1/4" x 1/4" x 3/4" long
 - Radius: 1/2"
 - Spring length: 1-1/4"
- Fits:** Brush holder
Model: 92N



RPI Part #RPC037
OEM Part # (None)

BRUSH CAP WITH INSERT

- 6 per package
 - 3/8-24 thread
- Fits:** Brush holder
Model: 92N



RPI is YOUR source for quality parts!

Ritter Models: C, D, E, F & J

RPI Part #RCB603
OEM Part #374G-3

BRUSH

- 2 per package
 - Size: 3/32" x 1/4" x 1/2" long
 - Bevel: 30°
- Fits:** Ritter Engine
Models: C & D



RPI Part #RCB604
OEM Part #374G37

BRUSH

- 2 per package
 - Size: 1/8" x 1/4" x 1/2" long
 - Bevel: 30°
- Fits:** Ritter Engine
Models: E, F & J



Visit the RPI website:
www.rpiparts.com

Wells

RPI Part #EMB001
OEM Part # E-106

BRUSH

- 2 per package
 - Size: 1/4" x 1/4" x 3/4" long
 - Radius: 1/2"
 - Spring length: 1-1/4"
- Fits:** WSM motor



RPI Part #BDB001
OEM Part #E-107

BRUSH

- 2 per package
 - Size: 1/4" x .190" x 21/32" long
 - Spring length: 1-1/8"
 - Copper shunt wire
- Fits:** Small brush Bodine motor with brush cap that has threaded O.D. and flat brass insert



RPI Part #DRB001
OEM Part #E-105

BRUSH

- 2 per package
 - Size: 1/4" x 3/8" x 15/16"
 - Radius: 5/8"
 - Spring length: 1-1/4"
 - Copper shunt wire
- Fits:** Large brush motor E-131

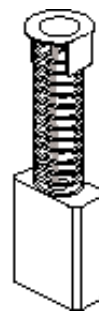

PLASTIC & METAL TUBING SNAKES

Plastic Tubing Snake RPI Part #RPT620

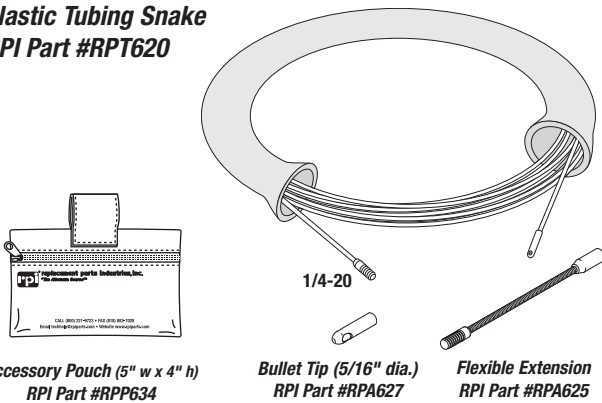

Accessory Pouch (5" w x 4" h)
RPI Part #RPP634

Bullet Tip (5/16" dia.)
RPI Part #RPA627

Flexible Extension
RPI Part #RPA625

Metal Tubing Snake RPI Part #RPT629

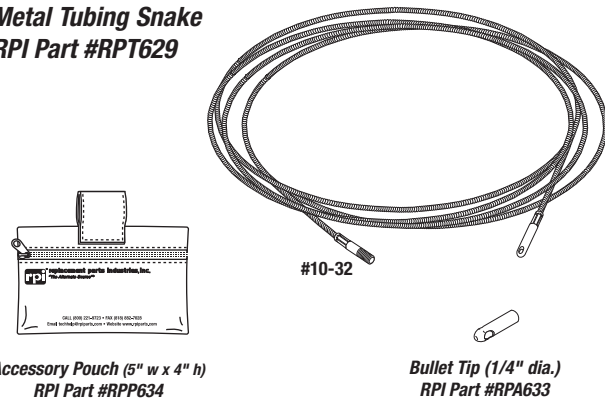

Accessory Pouch (5" w x 4" h)
RPI Part #RPP634

Bullet Tip (1/4" dia.)
RPI Part #RPA633

PLASTIC TUBING SNAKE RPI Part #RPT620



OEM Part #: (No OEM Part # Available)

- 15' of 3/16" dia. non-conductive fiberglass rod with PVC holder
- Includes Bullet Tip (RPI Part #RPA627), Flexible Extension (RPI Part #RPA625), and Accessory Pouch (RPI Part #RPP634)
- One end has fixed 3/16" dia. brass tip with 1/8" dia. hole; Opposite end has a 1/4-20 male thread adapter for adding attachments
- With Connector (RPI Part #RPA621), two Plastic Tubing Snakes can be joined together for those longer reach jobs
- Minimum bend radius: 2.5"

METAL TUBING SNAKE RPI Part #RPT629



OEM Part#: (No OEM Part # Available)

- 12' of 1/8" dia. flex cable
- Includes Bullet Tip (RPI Part #RPA633), and Accessory Pouch (RPI Part #RPP634)
- One end has a fixed 3/16" dia. brass tip with 1/8" dia. hole; Opposite end has a #10-32 male thread adapter for adding attachments
- With Connector (RPI Part #RPA631), two Metal Snakes can be joined together for those longer reach jobs
- Minimum bend radius: 3/4"

FLEXIBLE EXTENSION RPI Part #RPA625



- 3" long

Fits: Plastic Tubing Snake

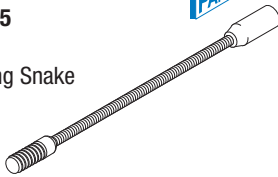

BULLET TIP (5/16" dia.) RPI Part #RPA627



- 5/16" dia. body with 3/16" dia. hole

Fits: Plastic Tubing Snake

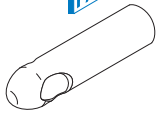

FIBER-OPTIC PULLER (5/16" dia.) RPI Part #RPA623



- Includes (1) #6-32 x 3/32" lg set screw to lock fiber-optic tube in place
- 5/16" dia. Bullet Tip
- 1-3/8" lg.

Fits: Plastic Tubing Snake

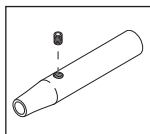

CONNECTOR (PLASTIC SNAKE) RPI Part #RPA621



- Allows two Plastic Snakes to be connected for a 30' reach

Fits: Plastic Tubing Snake

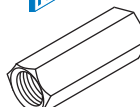

THE ATTACHMENTS SHOWN BELOW FIT BOTH SNAKES!

The Metal Snake requires the Adapter - RPI Part #RPA631

HOOK ATTACHMENT RPI Part #RPA624

- 3-5/8" lg
- Hook: 1-1/8" wide with a .40" wide opening

Fits: Both Snakes (Metal Snake requires Adapter - RPI Part #RPA631)

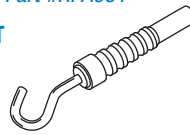

PULLING EYE RING RPI Part #RPA626

- 3/4" dia. pulling ring
- 5/16" dia. body

Fits: Both Snakes (Metal Snake requires Adapter - RPI Part #RPA631)

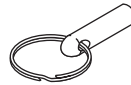

MAGNET ATTACHMENT RPI Part #RPA622

- 15/32" dia. magnet tip

Fits: Both Snakes (Metal Snake requires Adapter - RPI Part #RPA631)



ACCESSORY POUCH RPI Part #RPP634

- 5" w x 4" h
- 600 Denier Polyester
- Velcro® belt-loop flap

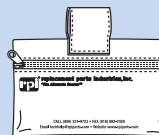

ADAPTER RPI Part #RPA631



- Allows a step-up for use with Plastic Snake attachments (Hook Attachment, Pulling Eye Ring, and Magnet Attachment)

Fits: Metal Snake

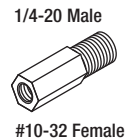

BULLET TIP (1/4" dia.) RPI Part #RPA633



- 1/4" dia. body with 3/16" dia. hole

Fits: Metal Snake

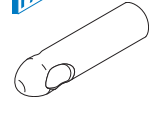

FIBER-OPTIC PULLER (1/4" dia.) RPI Part #RPA630



- Includes (1) #6-32 x 3/32" lg. set screw to lock fiber-optic tube in place
- 1/4" dia. Bullet Tip
- 1-1/8" lg.

Fits: Metal Snake

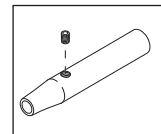

CONNECTOR (METAL SNAKE) RPI Part #RPA632



- Allows two Metal Snakes to be connected for a 24' reach

Fits: Metal Snake

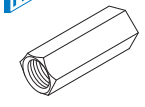

RPI Part #RPT766
OEM Part #32380

TIMER (30 MINUTE)

- 30 minutes with hold
- 15A per pole; 120/240V; DPST
- 1/4" Tabs
- Shaft: .250" dia. x .787 lg; "D" Flat
- Size: ~ 1.968" x 1.791" x 1.145" DP.
- Includes: Mounting screws
- Also available: Knob (RPI Part #TUK050)

Fits: 30 Minute Ultrasonic Cleaner

Models: L&R Ultrasonic Cleaners, Ney (Dentsply) Ultrasonic Cleaners, Patterson Dental Ultrasonic Cleaners & Henry Schein Dental Ultrasonic Cleaners

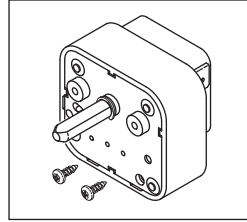

RPI Part #RPT767
OEM Part #40872

TIMER (60 MINUTE)

- 60 minutes without hold
- 15A per pole; 120/240V; DPST
- 1/4" Tabs
- Shaft: .250" dia. x .787 lg; "D" Flat
- Size: ~ 1.968" x 1.791" x 1.145" DP.
- Includes: Mounting screws
- Also available: Knob (RPI Part #TUK050)

Fits: 60 Minute Ultrasonic Cleaner

Models: L&R Ultrasonic Cleaners, Ney (Dentsply) Ultrasonic Cleaners, Patterson Dental Ultrasonic Cleaners & Henry Schein Dental Ultrasonic Cleaners

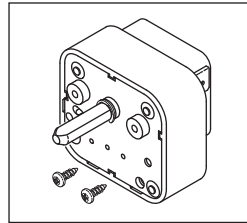

RPI Part #TUK050

OEM Part # (No OEM Part # Available)

KNOB

- Material: Black plastic
- Size: Fits .250" dia. 'D' Shaft; 1.61" OD x .85" tall

Fits: Timer

Models: L&R Ultrasonic Cleaners, Ney (Dentsply) Ultrasonic Cleaners, Patterson Dental Ultrasonic Cleaners & Henry Schein Dental Ultrasonic Cleaners

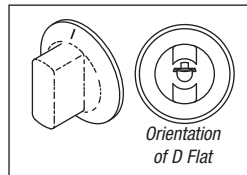

RPI Part #RPS768

OEM Part #32040

SWITCH

- Rocker Switch (on-off)
- 15A @ 250VAC, DPDT
- Illuminated green lens; black body
- Legend: I/O
- 3/16" Tabs
- Includes: Switch Cover (RPI Part #RPC769)
- Used as a Heater Switch or a Power Switch

Fits: Front / Side Panel

Models: L&R Ultrasonic Cleaners, Ney (Dentsply) Ultrasonic Cleaners, Patterson Dental Ultrasonic Cleaners & Henry Schein Dental Ultrasonic Cleaners

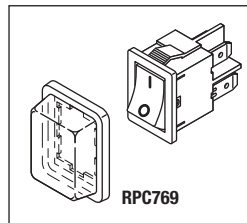

RPI Part #RPC769

OEM Part # (No OEM Part # Available)

SWITCH COVER

- Fits .82" x .59" switch bezel
- This rubber switch cover will extend the life of the switch by preventing moisture from entering into it
- Material: Clear silicone rubber
- Also included in: Switch (RPI Part #RPS768)

Fits: Switch

Models: L&R Ultrasonic Cleaners, Ney (Dentsply) Ultrasonic Cleaners, Patterson Dental Ultrasonic Cleaners & Henry Schein Dental Ultrasonic Cleaners

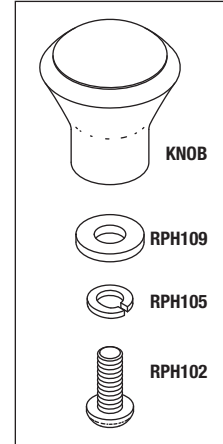
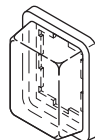

RPI Part #RPK801
OEM Part #40668

KNOB KIT

- Includes all parts as shown
- Fits:** Lid Cover
- Models:** L&R Ultrasonic Cleaners, Ney (Dentsply) Ultrasonic Cleaners, Patterson Dental Ultrasonic Cleaners & Henry Schein Dental Ultrasonic Cleaners

RPI Part #RPH109

OEM Part # (No OEM Part # Available)

#10 FLAT WASHER

- 25 per package
- Material: Stainless steel
- Also included in: Knob Kit (RPI Part #RPK801) and Hardware Kit (RPI Part #RPK402)

Fits: Lid Cover

Models: See Knob Kit (RPI Part #RPK801)



RPI Part #RPH105

OEM Part # (No OEM Part # Available)

#8 SPLIT LOCK WASHER

- 50 per package
- Material: Stainless steel
- Also included in: Knob Kit (RPI Part #RPK801) and Hardware Kit (RPI Part #RPK402)

Fits: Lid Cover

Models: See Knob Kit (RPI Part #RPK801)



RPI Part #RPH102

OEM Part # (No OEM Part # Available)

SCREW (8-32 x 1/2)

- 50 per package
- Material: Stainless steel
- Size: #8-32 x 1/2" lg.
- Also included in: Knob Kit (RPI Part #RPK801) and Hardware Kit (RPI Part #RPK402)

Fits: Lid Cover

Models: See Knob Kit (RPI Part #RPK801)

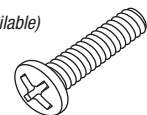

Dental Equipment

Models: L&R, Ney (Dentsply), Patterson Dental and Henry Schein® Dental Ultrasonic Cleaners

RPI Part #RPB640

OEM Part # (No OEM Part # Available)

BUMPER

- 4 per package
- Material: Polyurethane
- Size: ~ 1/2" square x 15/64" H
- Self adhesive backing

Fits: Chassis

Models: L&R Ultrasonic Cleaners, Ney (Dentsply) Ultrasonic Cleaners, Patterson Dental Ultrasonic Cleaners & Henry Schein Dental Ultrasonic Cleaners

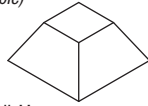

RPI Part #RPH742

OEM Part # (No OEM Part # Available)

PHILLIPS PAN HEAD SCREW #6

- 25 per package
- Material: Zinc plated steel
- Size: #6 self tapping screw x 1/2" lg.

Fits: Chassis

Models: L&R Ultrasonic Cleaners, Ney (Dentsply) Ultrasonic Cleaners, Patterson Dental Ultrasonic Cleaners & Henry Schein Dental Ultrasonic Cleaners

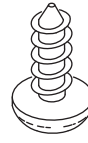

RPI Part #RPC557

OEM Part # (No OEM Part # Available)

HOSPITAL GRADE POWER CORD

- Length: 8 ft.
- 16/3 SJT, 60°C; 13A @ 125VAC
- Plug Type: NEMA 5-15P
- Connector Type: EN60320-C13; gray

Fits: Power Input Module

Models: L&R Ultrasonic Cleaners, Ney (Dentsply) Ultrasonic Cleaners, Patterson Dental Ultrasonic Cleaners & Henry Schein Dental Ultrasonic Cleaners

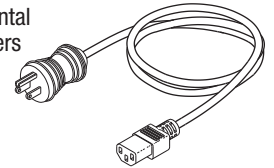

RPI Part #RPH800

OEM Part #32409



FUSE HOLDER

- 3/16" quick connect / solder tabs
- Accommodates metric 5mm x 20mm fuse
- 16A @ 250VAC
- Mounting hole size: .500" dia.
- Includes: mounting hardware

Fits: Rear Panel

Models: L&R Ultrasonic Cleaners, Ney (Dentsply) Ultrasonic Cleaners, Patterson Dental Ultrasonic Cleaners & Henry Schein Dental Ultrasonic Cleaners

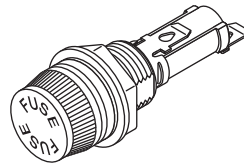

RPI Part #RPC028

OEM Part # (No OEM Part # Available)

HOSPITAL GRADE POWER CORD

- Length: 10 ft.
- 18/3 SJT, 60°C; 10A @ 125VAC
- Plug Type: NEMA 5-15P
- Connector Type: None; gray
- Use Strain Relief Bushing (RPI Part #RPB164) when replacing power cord

Fits: Chassis

Models: L&R Ultrasonic Cleaners, Ney (Dentsply) Ultrasonic Cleaners, Patterson Dental Ultrasonic Cleaners & Henry Schein Dental Ultrasonic Cleaners

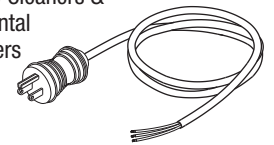

RPI Part #RPK538

OEM Part # (No OEM Part # Available)

FUSE KIT (5mm x 20mm TIME DELAY)

- Most Fuses to fit the variety of Ultrasonic Cleaners on the market can be found in this Kit. Also, see our other Fuse Kits in the General Shop Aids Section of our Catalog
- Kit includes 18-compartment Storage Case (RPI Part #RPB417)
- Fuses are also sold separately in quantities indicated below

Models: L&R Ultrasonic Cleaners, Ney (Dentsply) Ultrasonic Cleaners, Patterson Dental Ultrasonic Cleaners & Henry Schein Dental Ultrasonic Cleaners

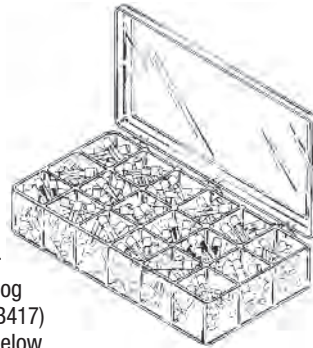

RPI PART #	OEM PART #	AMPS	VOLTS	TYPE	QTY
RPF521	No OEM Part # Available	1/32A	250V	Glass	5
RPF522	No OEM Part # Available	1/20A	250V	Glass	5
RPF523	No OEM Part # Available	1/10A	250V	Glass	5
RPF524	No OEM Part # Available	1/8A	250V	Glass	5
RPF525	No OEM Part # Available	1/5A	250V	Glass	5
RPF368	No OEM Part # Available	1/4A	250V	Glass	5
RPF526	No OEM Part # Available	2/5A	250V	Glass	5
RPF527	No OEM Part # Available	1/2A	250V	Glass	5
RPF528	No OEM Part # Available	4/5A	250V	Glass	5
RPF529	32025	1A	250V	Glass	5
RPF530	No OEM Part # Available	1-1/4A	250V	Glass	5
RPF531	32027	2A	250V	Glass	5
RPF532	32028	2-1/2A	250V	Glass	5
RPF533	No OEM Part # Available	4A	250V	Glass	5
RPF534	32030	5A	250V	Glass	5
RPF535	30125	8A	250V	Glass	5
RPF536	No OEM Part # Available	10A	250V	Glass	5
RPF537	31226	15A	250V	Glass	5

RPI Part #RPB164

OEM Part # (No OEM Part # Available)

STRAIN RELIEF BUSHING

- 8 per package
- Type: SR-6N3-4
- Cord Type: .325" - .360" round cable
- Mounting Hole: 5/8" dia. x 1/8" thk max
- Also available: Strain Relief Bushing Pliers (RPI Part #RPT172)

Fits: Chassis

Models: L&R Ultrasonic Cleaners, Ney (Dentsply) Ultrasonic Cleaners, Patterson Dental Ultrasonic Cleaners & Henry Schein Dental Ultrasonic Cleaners

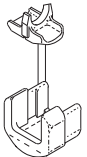

RPI Part #RPT604

OEM Part # (No OEM Part # Available)

DRAIN TUBING

- 1/4" ID x 3/8" OD
- Material: Clear flexible PVC; 68 Duro
- Sold by the foot (reel not included)

Fits: Drain Port

Models: L&R Ultrasonic Cleaners, Ney (Dentsply) Ultrasonic Cleaners, Patterson Dental Ultrasonic Cleaners & Henry Schein Dental Ultrasonic Cleaners

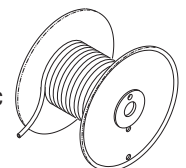

Cavitron® Models: BOBCAT® 25 KHz - G115, BOBCAT® Pro - G130, DualSelect™ Dispensing System - G118, JET Plus™ - G132, JET Plus™ - G137, JET with SPS™ - G120, Plus™ Scaler - G131, Plus™ Scaler - G136, Prophy-JET® Air Polishing System - G122, Prophy-Jet® - G138, Select™ Scaler 25K - G121, Select™ SPS™ 30K - G124, SPS™ Surface Mount Ultrasonic Scaler - G98a, SPS™ Ultrasonic Scaler - G119, & Touch™ Scaler - G1000

For Models These Parts Fit, See Page 1608.

WARNING: Incoming water supply line pressure to the Scaler must be 25 psi (172 kPa) to 60 psi (414 kPa). Water supply line must be shut off or disconnected when Scaler is not in use.

RPI Part #DSK021
OEM Part # (No OEM Part # Available)

WATER FILTER KIT
• Includes all parts as shown
• See **WARNING** above
• See **SERVICE TIP** below
Fits: Water Supply Line Assembly

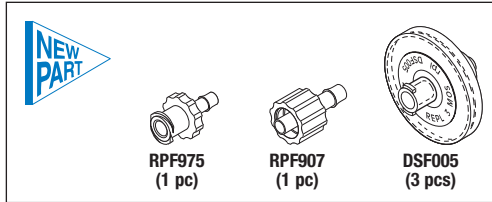

Just need the Disc Filter?



RPI Part #DSF005
OEM Part #90158

DISC FILTER (WATER)
• 10 per package
• 20 Micron, 25 mm; Ports: Luer lock
• Maximum Pressure Rating: 60 psi (414 kPa)
• See **WARNING** above
• See **SERVICE TIP** below
Fits: Luer Lock Fittings on Water Supply Hose Assembly and Water Supply Line Assembly

RPI Part #DSK001
OEM Part #90172

RETROFIT WATER FILTER KIT
• Includes all parts as shown
• See **WARNING** above
• See **SERVICE TIP** below
Fits: Water Supply Hose Assembly (Braided)

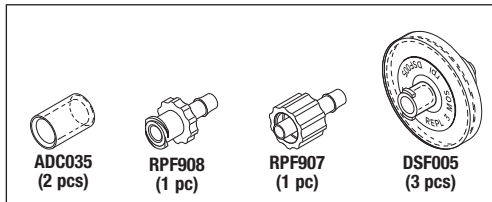

SERVICE TIP: Replace the Disc Filter (Water) (RPI Part #DSF005) every 3 months or when the water filter becomes discolored to prevent reduced water flow to the system.

RPI Part #DSA002
OEM Part #60367

DUCKBILL FILTER ASSEMBLY
• Includes all parts as shown
• Clear plastic housing with 1/16" barbs, Hex body design for easy replacement of internal parts
Fits: Powder Chamber

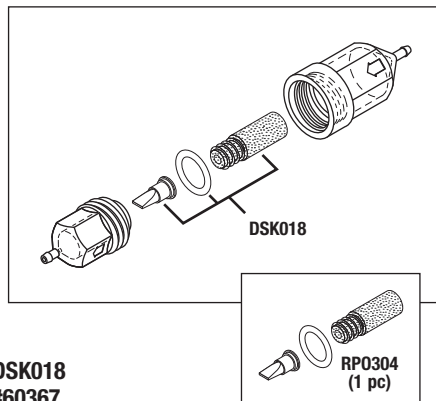

Just need the Repair Kit?

RPI Part #DSK018
OEM Part #60367
REPAIR KIT (DUCKBILL FILTER ASSEMBLY)
• Includes all parts as shown

SERVICE TIP: The Luer Locks below can also be used for water hose in-line connection repairs.

LUER LOCKS (1/8" BARB)

• 10 per package
• Material: Clear polycarbonate
Fits: 1/8" or 3 mm ID tubing

RPI Part #RPF974
OEM Part # (No OEM Part # Available)
LUER LOCK (MALE x 1/8" BARB)

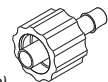

RPI Part #RPF975
OEM Part #621065001
LUER LOCK (FEMALE x 1/8" BARB)

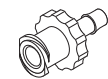

LUER LOCKS (5/32" BARB)

• 10 per package
• Material: Clear polycarbonate
Fits: .150" (4 mm) ID tubing

RPI Part #RPF907
OEM Part #621066001
LUER LOCK (MALE x 5/32" BARB)

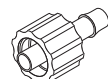

RPI Part #RPF908
OEM Part #621065001
LUER LOCK (FEMALE x 5/32" BARB)

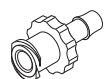

RPI Part #RP0924
OEM Part #62605

O-RING (GREEN)
• 12 per package
• Size: .145" ID x .285" OD x .070" C/S; Material: Viton®, Duro: 75
Fits: Insert Stack Groove; for Insert Types: Classic P, SLI, PEC, Jet Air Polishing Insert, Cavitron MED



RPI Part #RP0342
OEM Part #62351

O-RING (BLACK)
• 12 per package
• Size: .145" ID x .285" OD x .070" C/S; Material: Viton®, Duro: 75
Fits: Insert Stack Groove; for Insert Types: TFI, FSI, FSI-SLI, Bellissima, Cavitron THINsert (Dental Ultrasonic Scalers)



Call Us Toll-Free Monday–Friday, 8:00 AM–4:30 PM (Pacific Time), (800) 221-9723

Dental Equipment

Cavitron® Models: BOBCAT® 25 Khz - G115, BOBCAT® Pro - G130, DualSelect™ Dispensing System - G118, JET Plus™ - G132, JET Plus™ - G137, JET with SPST™ - G120, Plus™ Scaler - G131, Plus™ Scaler - G136, Prophy-JET® Air Polishing System - G122, Prophy-Jet® - G138, Select™ Scaler 25K - G121, Select™ SPST™ 30K - G124, SPST™ Surface Mount Ultrasonic Scaler - G98a, SPST™ Ultrasonic Scaler - G119, & Touch™ Scaler - G100

For Models These Parts Fit, See Page 1608.

WARNING: Incoming water supply line pressure to the Scaler must be 25 psi (172 kPa) to 60 psi (414 kPa). Water supply line must be shut off or disconnected when Scaler is not in use.

RPI Part #DSA047
OEM Part #90125



WATER SUPPLY LINE ASSEMBLY

- Includes all parts as shown
- Replace the Disc Filter (Water) every 3 months or when the Disc Filter (Water) becomes discolored to prevent reduced water flow to the system. The RPI Water Supply Line Assembly includes two (2) extra Disc Filters (Water) plus a PM Log for your convenience.
- See **WARNING** above
- Also available: Disc Filter (Water) (10-pack) (RPI Part #DSF005), Union Fitting (3/16") (RPI Part #DSF048), Male Connector (3/16" Push-In x #10-32 Male) (RPI Part #RPF976), Quick Disconnect, Female (Panel Mount 1/4" Poly) (RPI Part #RPF920), Cord Strap (White 6") (RPI Part #RPS672), and Cord Clip (RPI Part #ADC058)

Fits: 3/16" Push-In Union Fitting(s)/Cavitron to water source

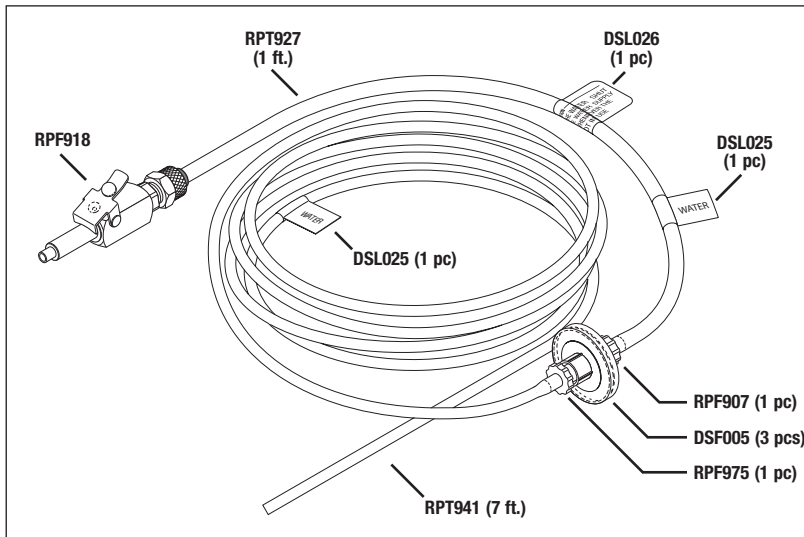

RPI Part #DSA046

OEM Part # (No OEM Part # Available)



WATER SUPPLY HOSE ASSEMBLY (BRAIDED)

- Includes all parts as shown
- Replace the Disc Filter (Water) every 3 months or when the Disc Filter (Water) becomes discolored to prevent reduced water flow to the system. The RPI Water Supply Hose Assembly includes two (2) extra Disc Filters (Water) plus a PM Log for your convenience.
- See **WARNING** above
- Also available: Disc Filter (Water) (10-pack) (RPI Part #DSF005), Quick Disconnect, Female (Panel Mount 1/4" Poly) (RPI Part #RPF920), Cord Strap (White 6") (RPI Part #RPS672), and Cord Clip (RPI Part #ADC058)

Fits: 1/4" Polyflo Fitting/Cavitron to water source

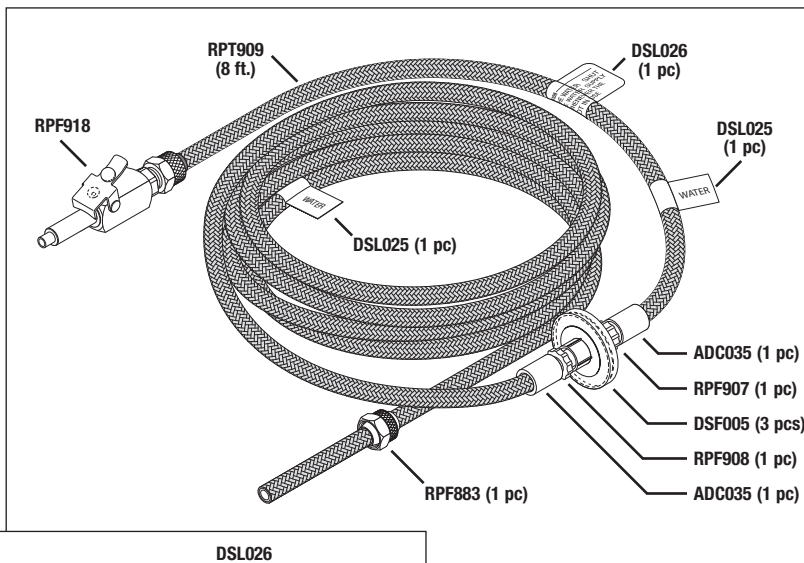

Just need the Water Hose with PolyFlo Nuts and Labels?

RPI Part #DSH003
OEM Part #60388

WATER HOSE (BRAIDED BLUE)

- Includes all parts as shown
- Also available: Male Quick Disconnect (1/4" Poly Auto Shut-Off) (RPI Part# RPF918) and Cord Strap (White 6") (RPI Part #RPS672)

Fits: Cavitron to Water Source

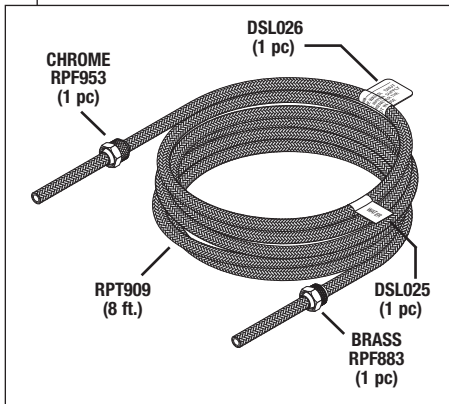

RPI Part #RPS672
OEM Part # (No OEM Part # Available)

CORD STRAP (WHITE 6")

- 3 per package
- Size: .5" wide x 6" lg.
- White strap with white button
- Use to strap air and water supply lines, power cords, cables, and wires

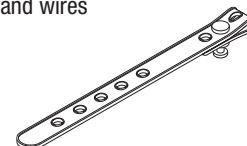

For Water Supply Hose Accessories, See Page 1602.

FAX: (818) 882-7028 • E-MAIL: order@rpiarts.com • WEBSITE: www.rpiarts.com

Cavitron® Models: BOBCAT® 25 KHz - G115, BOBCAT® Pro - G130, DualSelect™ Dispensing System - G118, JET Plus™ - G132, JET Plus™ - G137, JET with SPS™ - G120, Plus™ Scaler - G131, Plus™ Scaler - G136, Prophy-JET® Air Polishing System - G122, Prophy-Jet® - G138, Select™ Scaler 25K - G121, Select™ SPS™ 30K - G124, SPS™ Surface Mount Ultrasonic Scaler - G98a, SPS™ Ultrasonic Scaler - G119, & Touch™ Scaler - G1000

For Models These Parts Fit, See Page 1608.

WATER SUPPLY HOSE ACCESSORIES

RPI Part #RPF918
OEM Part #79521

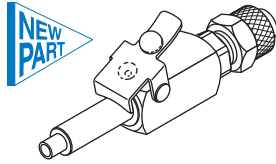

QUICK DISCONNECT, MALE
(1/4" POLY AUTO SHUT-OFF)

- Used with air or water lines
 - Material: Chrome plated brass with auto shut-off
 - Includes: Polyflo Nut (1/4" Chrome) (RPI Part #RPF953)
- Fits:** 1/4" Air and Water Lines

RPI Part #RPF920
OEM Part # (No OEM Part # Available)

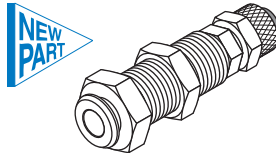

QUICK DISCONNECT, FEMALE
(PANEL MOUNT 1/4" POLY)

- Used with air or water lines
 - Material: Chrome plated brass with auto shut-off
 - Mounting hole size: 1/2" dia.
 - Includes: Polyflo Nut (1/4" Chrome) (RPI Part #RPF953)
- Fits:** 1/4" Air and Water Lines

CHROME

RPI Part #RPF953
OEM Part # (No OEM Part # Available)

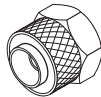

POLYFLO NUT (1/4" CHROME)

- 5 Per package
 - Material: Chrome plated brass
 - Includes: Polyflo Sleeve/Ferrule (1/4") (RPI Part #ADS032)
 - Included in: Water Hose (Braided Blue) (RPI Part #DSH003), Air Hose (Braided Gray) (RPI Part #DSH009), Male Quick Disconnect, (1/4" Poly Auto Shut-Off) (RPI Part #RPF918), and Female Quick Disconnect (1/4" Poly Auto Shut-Off) (RPI Part #RPF920)
- Fits:** Quick Connect to Air or Water Line

BRASS

RPI Part #RPF883
OEM Part # (No OEM Part # Available)



POLYFLO NUT (1/4" BRASS)

- 5 per package
 - Fits: 1/4" OD plastic tube
 - Material: Brass
 - Includes: Polyflo Sleeve/Ferrule (1/4") (RPI Part #ADS032)
 - Included in: Water Hose (Braided Blue) (RPI Part #DSH003), Air Hose (Braided Gray) (RPI Part #DSH009), and Water Supply Hose Assembly (Braided) (RPI Part #DSA046)
- Fits:** Water and Air Hoses

RPI Part #ADS032
OEM Part # (No OEM Part # Available)



POLYFLO SLEEVE/FERRULE (1/4")

- 25 per package
 - 1/4" Polyflo black plastic
- Fits:** 1/4" OD Tubing, Polyflo Nuts

RPI Part #DSL025
OEM Part # (No OEM Part # Available)

WATER WATER

LABEL (WATER)

- 3 per package
- Included in: Water Supply Line Assembly (RPI Part #DSA047), Water Supply Hose Assembly (Braided) (RPI Part #DSA046), and Water Hose (Braided Blue) (RPI Part #DSH003)

RPI Part #DSL026
OEM Part # (No OEM Part # Available)

CAUTION
ALWAYS CLOSE THE WATER SHUT OFF VALVE IN THE WATER SUPPLY TO THE UNIT WHENEVER THE UNIT IS NOT IN USE.

LABEL (CAUTION)

- 3 per package
- Included in: Water Supply Line Assembly (RPI Part #DSA047), Water Supply Hose Assembly (Braided) (RPI Part #DSA046), and Water Hose (Braided Blue) (RPI Part #DSH003)

TUBING (.107" ID x 3/16" OD BLUE)

- Available by the foot or in a box of 100 ft.
 - Size: .107" ID x 3/16" OD blue polyurethane
- Fits:** 1/8" Barb or 3/16" Push-in Fitting

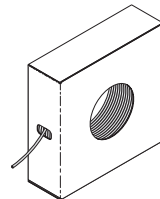

Just Ask For:

RPI Part #RPT941
TUBING (.107" ID x 3/16" OD BLUE) - Sold by the Foot

RPI Part #RXT001
TUBING (.107" ID x 3/16" OD BLUE) - Box of 100 ft.

TUBING (.160" ID x 1/4" OD BLUE)

- Available by the foot or in a box of 100 ft.
 - Size: .160" ID x 1/4" OD blue polyurethane
- Fits:** 1/4" Polyflo Fitting, 1/4" Push-in Fitting, and 5/32" Luer Lock Barb fitting

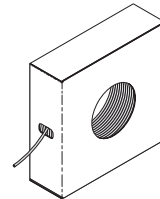

Just Ask For:

RPI Part #RPT927
TUBING (.160" ID x 1/4" OD BLUE) - Sold by the Foot

RPI Part #RPT999
TUBING (.160" ID x 1/4" OD BLUE) - Box of 100 ft.

BRAIDED TUBING (1/4" OD BLUE)

- Available by the foot or in a box of 100 ft.
 - Size: .150" ID x .250" OD PVC tubing with blue over braided sleeve
- Fits:** 1/4" Polyflo or 5/32" Barb

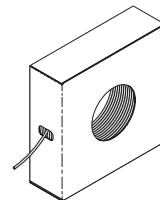

Just Ask For:

RPI Part #RPT909
BRAIDED TUBING (1/4" OD BLUE) - Sold by the Foot

RPI Part #RPT910
BRAIDED TUBING (1/4" OD BLUE) - Box of 100 ft.

Call Us Toll-Free Monday–Friday, 8:00 AM–4:30 PM (Pacific Time), (800) 221-9723

Dental Equipment

Cavitron® Models: BOBCAT® 25 KHz - G115, BOBCAT® Pro - G130, DualSelect™ Dispensing System - G118, JET Plus™ - G132, JET Plus™ - G137, JET with SPST™ - G120, Plus™ Scaler - G131, Plus™ Scaler - G136, Prophy-JET® Air Polishing System - G122, Prophy-Jet® - G138, Select™ Scaler 25K - G121, Select™ SPST™ 30K - G124, SPST™ Surface Mount Ultrasonic Scaler - G98a, SPST™ Ultrasonic Scaler - G119, & Touch™ Scaler - G100

For Models These Parts Fit, See Page 1608.

**RPI Part #DSA008
OEM Part #63856**

HOSE ASSEMBLY & FILTER (AIR)

- Includes all parts as shown
- Also available: Braided Tubing (1/4" OD Gray) (Box of 100 ft.) (RPI Part #RPT912), Braided Tubing (1/4" OD Gray) (RPI Part #RPT911) - sold by the foot, Quick Disconnect, Female (Panel Mount 1/4" Poly) (RPI Part #RPF920), Cord Strap (White 6") (RPI Part #RPS672), and Cord Clip (RPI Part #ADC058)

Fits: Cavitron to Air Source

Just need the Air Hoses with PolyFlo Nuts and Labels?

**RPI Part #DSH009
OEM Part #80786**

AIR HOSE (BRAIDED GRAY)

- Includes all parts as shown
- Also available: Braided Tubing (1/4" OD Gray) (Box of 100 ft.) (RPI Part #RPT912), Braided Tubing (1/4" OD Gray) (RPI Part #RPT911) - sold by the foot, Cord Strap (White 6") (RPI Part #RPS672), and Cord Clip (RPI Part #ADC058)

Fits: Cavitron to Air Source

RPI Part #DSL024

OEM Part # (No OEM Part # Available)

LABEL (AIR)

- 3 per package
- Included in: Hose Assembly & Filter (Air) (RPI Part #DSA008) and Air Hose (Braided Gray) (RPI Part #DSH009)



**RPI Part #RPA915
OEM Part #90088**

AIR FILTER SSEMBLY

- Ports: #10-32 (M5 x 0.8)
- Manual drain
- Includes all parts as shown

Fits: Air Source to Cavitron/ 1/4" Polyflo Air Hose

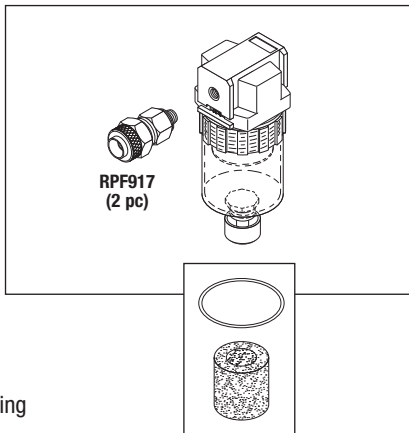

Just need the Filter Element?

RPI Part #RPE916

OEM Part # (No OEM Part # Available)

FILTER ELEMENT

- 5 Micron
- Includes: Filter element and O-ring

Fits: Air Filter Assembly

Just need the PolyFlo Fitting?

RPI Part #RPF917

OEM Part # (No OEM Part # Available)

POLYFLO FITTING (1/4" TUBE x #10-32 MALE)

- 5 per package
- Material: Brass with rubber sealing washer
- For use with most plastic and soft metal tubing

Fits: Air Filter Assembly

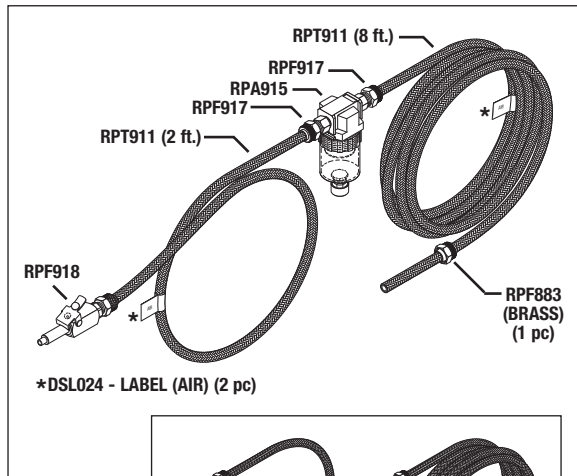
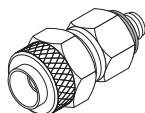

*DSL024 - LABEL (AIR) (2 pc)

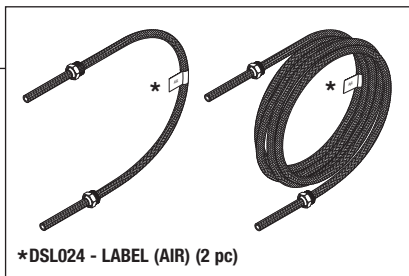

*DSL024 - LABEL (AIR) (2 pc)

RPI Part #RPS672

OEM Part # (No OEM Part # Available)

CORD STRAP (WHITE 6")

- 3 per package
- Size: .5" wide x 6" lg.
- White strap with white button
- Use to strap air and water supply lines, power cords, cables, and wires

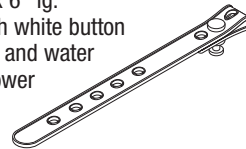

SERVICE TIP: These Quick Disconnects can be used for your Air and Water Lines.

RPI Part #RPF918

OEM Part #79521



QUICK DISCONNECT, MALE (1/4" POLY AUTO SHUT-OFF)

- Used with air or water lines
- Material: Chrome plated brass with auto shut-off
- Includes: Polyflo Nut (1/4" Chrome) (RPI Part #RPF953)

Fits: 1/4" Air and Water Lines

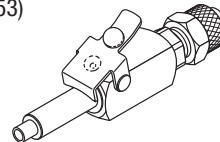

RPI Part #RPF920

OEM Part # (No OEM Part # Available)



QUICK DISCONNECT, FEMALE (PANEL MOUNT 1/4" POLY)

- Used with air or water lines
- Material: Chrome plated brass with auto shut-off
- Mounting hole size: 1/2" dia.
- Includes: Polyflo Nut (1/4" Chrome) (RPI Part #RPF953)

Fits: 1/4" Air and Water Lines

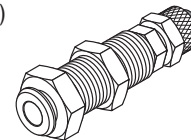

BRAIDED TUBING (1/4" OD GRAY)

- Available by the foot or in a box of 100 ft.
- Size: .150" ID x .250" OD PVC tubing with gray over braided sleeve

Fits: 1/4" Polyflo or 5/32" Barb

Just Ask For:

**RPI Part #RPT911
BRAIDED TUBING (1/4" OD GRAY) - Sold by the Foot**

**RPI Part #RPT912
BRAIDED TUBING (1/4" OD GRAY) - Box of 100 ft.**

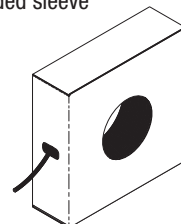

Cavitron® Models: BOBCAT® 25 KHz - G115, BOBCAT® Pro - G130, DualSelect™ Dispensing System - G118, JET Plus™ - G132, JET Plus™ - G137, JET with SPST™ - G120, Plus™ Scaler - G131, Plus™ Scaler - G136, Prophy-JET® Air Polishing System - G122, Prophy-Jet® - G138, Select™ Scaler 25K - G121, Select™ SPST™ 30K - G124, SPST™ Surface Mount Ultrasonic Scaler - G98a, SPST™ Ultrasonic Scaler - G119, & Touch™ Scaler - G1000

FOOT CONTROLS

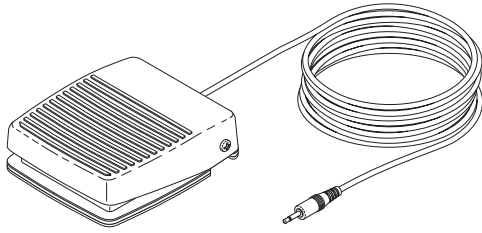

RPI Part #DSF012
OEM Part #565162005

FOOT CONTROL

- 2 Switch boost feature
- 8 foot long black #22 AWG shielded cord with .097" diameter pin molded plug
- Size: 3.44" W x 4.00" L x 1.09" H
- Non-skid base and raised ribs on pedal for positive traction

Fits: Cavitron G124

Model: Cavitron® Select™ SPST™ 30K - G124

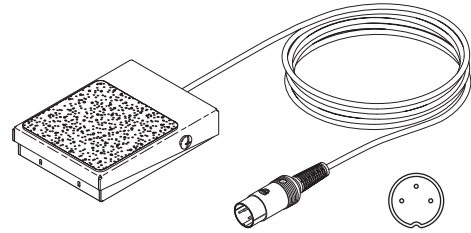

RPI Part #DSF039
OEM Part #77885

FOOT CONTROL

- Single switch position
- 8 foot long gray #24 AWG shielded cord with 3 pin round plug
- Size: 2.63" W x 3.53" L x .85" H
- Non-skid base and pedal for positive traction

Fits: Cavitron G115

Model: Cavitron® BOBCAT® 25 KHz - G115

3 PIN
CONFIGURATION

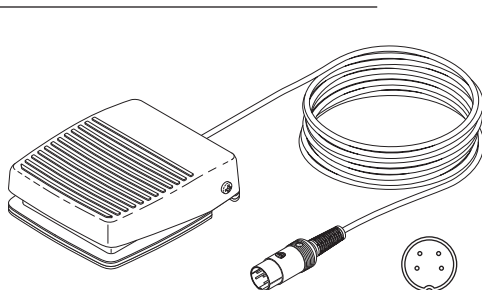

RPI Part #DSF013
OEM Part #565138002, 565138003

FOOT CONTROL

- 2 Switch boost feature
- 8 foot long gray #24 AWG shielded cord with 4 pin round plug
- Size: 3.44" W x 4.00" L x 1.09" H
- Non-skid base and raised ribs on pedal for positive traction

Fits: Cavitrons G119, G120, & G122

Models: Cavitron® SPST™ Ultrasonic Scaler - G119, Cavitron® JET with SPST™ - G120, and Cavitron® Prophy-JET® Air Polishing System - G122

4 PIN
CONFIGURATION

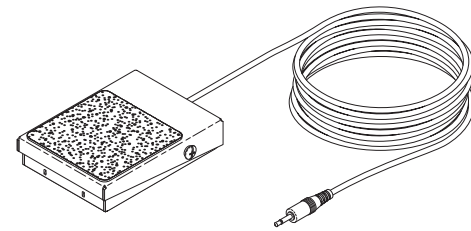

RPI Part #DSF040
OEM Part #565162002

FOOT CONTROL

- Single switch position
- 8 foot long black #22 AWG shielded cord with .097" diameter pin molded plug
- Size: 2.63" W x 3.53" L x .85" H
- Non-skid base and pedal for positive traction

Fits: Cavitron G121

Model: Cavitron® Select™ Scaler 25K - G121

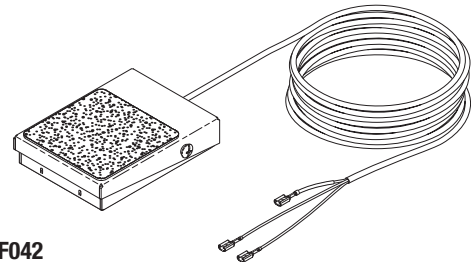

RPI Part #DSF042
OEM Part #565162006

FOOT CONTROL

- Single switch position
- 8 foot long gray #24 AWG shielded cord, three wire with 3/16" quick connect terminals
- Size: 2.63" W x 3.53" L x .85" H
- Non-skid base and pedal for positive traction

Fits: Cavitron G130

Model: Cavitron® BOBCAT® Pro - G130

Dental Equipment

Cavitron® Models: BOBCAT® 25 KHz - G115, BOBCAT® Pro - G130, DualSelect™ Dispensing System - G118, JET Plus™ - G132, JET Plus™ - G137, JET with SPST™ - G120, Plus™ Scaler - G131, Plus™ Scaler - G136, Prophy-JET® Air Polishing System - G122, Prophy-Jet® - G138, Select™ Scaler 25K - G121, Select™ SPST™ 30K - G124, SPST™ Surface Mount Ultrasonic Scaler - G98a, SPST™ Ultrasonic Scaler - G119, & Touch™ Scaler - G100

For Models These Parts Fit, See Page 1608.

WATER SOLENOID VALVES

**RPI Part #DSV006
OEM Part #571070003**

SOLENOID VALVE (WATER)

- Ports: 1/8" FPT; 2 way; N.C.
 - 24VDC, 60Hz., 3W; 6" lg. wires with 2 pin connector
 - Material: Stainless steel body; Viton® seals
 - Includes all parts as shown
- Fits:** Water Chassis

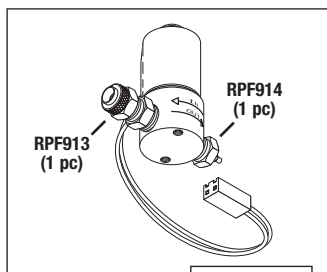

Just need the Repair Kit?

RPI Part #DSK016

OEM Part # (No OEM Part # Available)

SOLENOID VALVE REPAIR KIT

- Includes: Plunger with spring and O-ring
 - Also available: Double Ended Spanner Wrench (RPI Part #RPT501)
- Fits:** Solenoid Valve (Water)

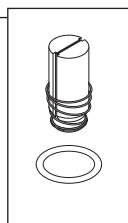

Just need the Coil?

RPI Part #DSC017

OEM Part # (No OEM Part # Available)

COIL (SOLENOID VALVE)

- 24VDC, 3W (488Ω), 6" lg. wires with 2 pin connector
- Fits:** Solenoid Valve (Water)

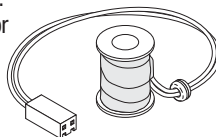

**RPI Part #DSV015
OEM Part #571070002**

SOLENOID VALVE (WATER)

- Ports: 1/8" FPT; 2 way; N.C.
 - 24VDC, 60Hz., 3W; 6" lg. wires with 2 pin connector
 - Material: Stainless steel body; Viton® seals
 - Includes all parts as shown
- Fits:** Water Chassis

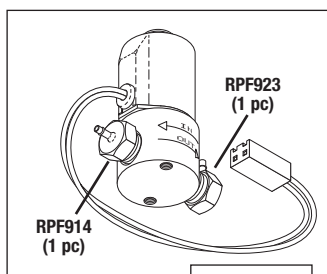

Just need the Repair Kit?

RPI Part #DSK016

OEM Part # (No OEM Part # Available)

SOLENOID VALVE REPAIR KIT

- Includes: Plunger with spring and O-ring
 - Also available: Double Ended Spanner Wrench (RPI Part #RPT501)
- Fits:** Solenoid Valve (Water)

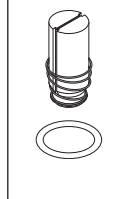

Just need the Coil?

RPI Part #DSC017

OEM Part # (No OEM Part # Available)

COIL (SOLENOID VALVE)

- 24VDC, 3W (488Ω), 6" lg. wires with 2 pin connector
- Fits:** Solenoid Valve (Water)

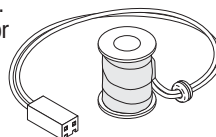

**RPI Part #DSV019
OEM Part #81258**

SOLENOID VALVE (WATER)

- Ports: 1/8" FPT; 2 way; N.C.
 - 24VAC, 50-60Hz., 6W; 6" lg. wires with 2 pin connector
 - Material: Brass body; Buna N seals
 - Includes all parts as shown
- Fits:** Transformer Mount and Lavage Assembly

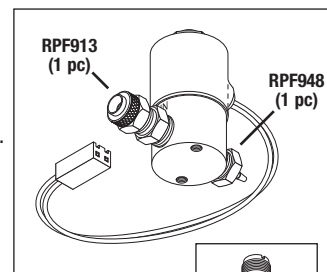

Just need the Repair Kit?

RPI Part #DSK020

OEM Part # (No OEM Part # Available)

SOLENOID VALVE REPAIR KIT

- Includes: Plunger with spring, O-ring and bonnet
- Fits:** Solenoid Valve (Water)

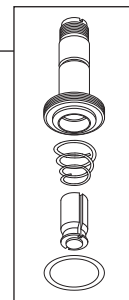

RPI Part #RPF913

OEM Part # (No OEM Part # Available)

POLYFLO FITTING (1/4" TUBE x 1/8" MPT)

- 5 per package
 - Material: Brass body with plastic sleeve/ferrule
 - Also available: Polyflo Nut (RPI Part #RPF883)
 - Included in: Solenoid Valve (Water) (RPI Part #'s DSV006 & DSV019)
- Fits:** 1/4" OD Plastic Tubing x 1/8" FPT Ports

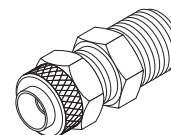

RPI Part #RPF914

OEM Part # (No OEM Part # Available)

ADAPTOR (1/16" BARB x 1/8" MPT)

- 5 per package
 - Material: Brass
 - Included in: Solenoid Valve (Water) (RPI Part #'s DSV006 & DSV015)
- Fits:** 1/16" ID Plastic Tubing x 1/8" FPT Ports

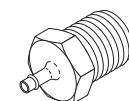

RPI Part #RPF923

OEM Part #63827

ADAPTOR ELBOW (1/16" BARB x 1/8" MPT)

- 5 per package
 - Material: Brass
 - Included in: Solenoid Valve (Water) (RPI Part #DSV015)
- Fits:** 1/16" ID Plastic Tubing x 1/8" FPT Port

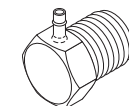

RPI Part #RPF948

OEM Part # (No OEM Part # Available)

ADAPTOR (1/16" BARB x 1/8" MPT)

- 5 per package
 - Material: Nickel plated brass
 - See the special **NOTE** to the right
 - Included in: Solenoid Valve (Water) (RPI Part #DSV019)
- Fits:** 1/16" ID Plastic Tubing x 1/8" FPT Ports

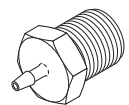

NOTE: This Adaptor has a unique orifice that allows for the precise control of the solenoid valve output.

Cavitron® Models: BOBCAT® 25 KHz - G115, BOBCAT® Pro - G130, DualSelect™ Dispensing System - G118, JET Plus™ - G132, JET Plus™ - G137, JET with SPST™ - G120, Plus™ Scaler - G131, Plus™ Scaler - G136, Prophy-JET® Air Polishing System - G122, Prophy-Jet® - G138, Select™ Scaler 25K - G121, Select™ SPST™ 30K - G124, SPST™ Surface Mount Ultrasonic Scaler - G98a, SPST™ Ultrasonic Scaler - G119, & Touch™ Scaler - G1000

For Models These Parts Fit, See Page 1608.

SOLENOID VALVE (PINCH)

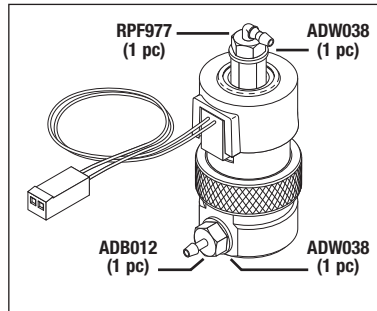

RPI Part #DSV011
OEM Part #629194002

SOLENOID VALVE (PINCH)

- Ports: #10-32 Female
 - 24 VDC, 0.67 W, 0.86 Ω, 4.50" lg. wires with 2 pin connector
 - Includes all parts as shown
 - Also available: Pinch Tubing (RPI Part #RXT016)
- Fits:** Chassis Bracket

RPI Part #RPF977
OEM Part #6390253



ELBOW FITTING (1/16" BARB x #10-32 MALE)

- 10 per package; Material: Natural polypropylene
- Fits:** Pinch Valve and Manifold Regulator Assembly



RPI Part #RXT016
OEM Part #61631



PINCH TUBING (1/16" ID x 1/8" OD RED)

- Sold by the foot (reel not included)
 - Material: Red PVC
 - Also available: Uni-Clamp (RPI Part #ADC034) and Sleeve Clamp (1/8") (RPI Part #RXC023)
- Fits:** Pinch Valves, 1/16" Barb Fittings

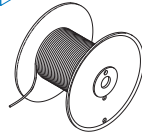

RPI Part #ADB012
OEM Part # (No OEM Part # Available)

BARB (1/16" BARB x #10-32 MALE)

- 10 per package; Nickel plated brass
- Fits:** 1/16" ID Tubing

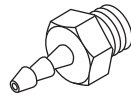

RPI Part #ADW038
OEM Part # (No OEM Part # Available)

FLAT WASHER

- 50 per package; Material Nylon®
 - Size: .187" ID x .312" OD x .031" thk
- Fits:** #10-32 male thread port



CHECK VALVE KIT

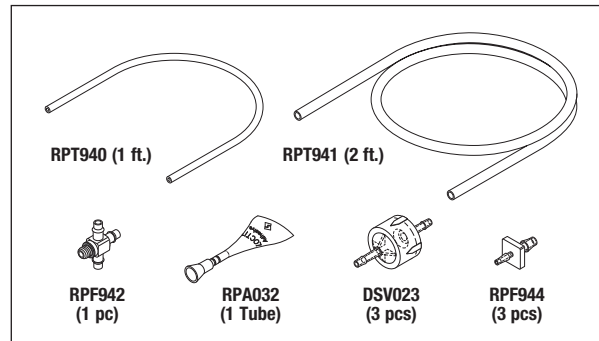

RPI Part #DSK022
OEM Part #81167

CHECK VALVE KIT

- Includes all parts as shown
 - All parts also sold separately
 - This is an upgrade kit for units without check valves or with dual metallic check valves installed
- Fits:** Mounting Plate Assembly

RPI Part #DSV023
OEM Part #629211001

CHECK VALVE

- 3 per package
 - Size: .67" OD x .46" lg. body with 1/8" hose barbs
 - Material: Clear plastic body, silicone diaphragm
 - Temperature: 180°F max; Pressure: 50 PSI max
- Fits:** Mounting Plate Assembly

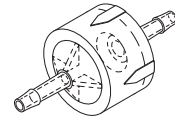

RPI Part #RPF942
OEM Part #623064002

CROSS FITTING (1/8" BARB x #10-32 MALE)

- 5 per package
 - Material: Nickel plated brass
 - Includes: Sealing washer
- Fits:** Quick Connect to Bottle "A" and 1/8" ID Tubing

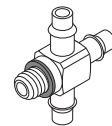

RPI Part #RPF944
OEM Part #621068001

ADAPTOR FITTING (1/16" BARB x 1/8" BARB)

- 10 per package
 - Material: Clear polypropylene
- Fits:** 1/16" ID and 1/8" ID Tubing

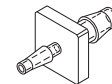

RPI Part #ADC034
OEM Part # (No OEM Part # Available)

UNI-CLAMP

- 20 per package; Material: Plastic
 - Also available: Universal Sleeve Tool (RPI Part #RPT296)
- Fits:** 1/8" OD Tubing with 1/16" Barb



RPI Part #RXC023
OEM Part # (No OEM Part # Available)

SLEEVE CLAMP (1/8")

- 20 per package; Material: Plastic
 - Also available: Universal Sleeve Tool (RPI Part #RPT296)
- Fits:** 1/8" OD Tubing with 1/16" Barb

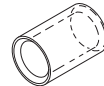

RPI Part #ADC035
OEM Part # (No OEM Part # Available)

SLEEVE CLAMP

- 20 per package; Material: Plastic
 - Included in: Retrofit Water Filter kit (RPI Part #DSK001)
 - Also available: Universal Sleeve Tool (RPI Part #RPT296)
- Fits:** 1/4" OD Tubing with 1/8" Barb

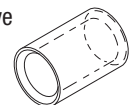

Dental Equipment

Cavitron® Models: BOBCAT® 25 KHz - G115, BOBCAT® Pro - G130, DualSelect™ Dispensing System - G118, JET Plus™ - G132, JET Plus™ - G137, JET with SPS™ - G120, Plus™ Scaler - G131, Plus™ Scaler - G136, Prophy-JET® Air Polishing System - G122, Prophy-Jet® - G138, Select™ Scaler 25K - G121, Select™ SPS™ 30K - G124, SPS™ Surface Mount Ultrasonic Scaler - G98a, SPS™ Ultrasonic Scaler - G119, & Touch™ Scaler - G1000

For Models These Parts Fit, See Page 1608.

NEEDLE VALVE (WATER)

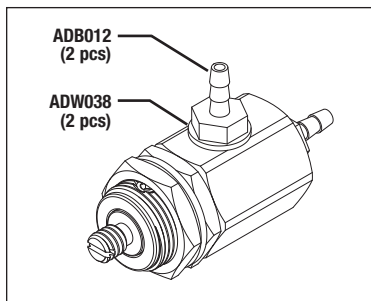

RPI Part #DSV027
OEM Part #629202001



NEEDLE VALVE (WATER)

- Ports: #10-32 Female with 1/16" barb fittings
- Material: Nickel plated brass
- Includes all parts as shown
- Fits:** Front panel

TUBING (1/16" ID)

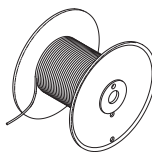

RPI Part #RPT973
OEM Part #625072001

TUBING (1/16" ID x 3/16" OD BLACK)

- Material: Hi-Temp Black Viton
- Ratings: -30°F to 400°F max
- Sold by the foot (reel not included)
- Fits:** 1/16" Barb Fittings

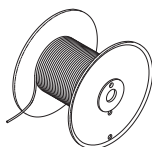

RPI Part #RPT940
OEM Part #61963

TUBING (1/16" ID x 1/8" OD CLEAR)

- Material: Polyurethane
- Sold by the foot (reel not included)
- Fits:** 1/16" Barb Fittings

SERVICE TIP: Use with Tubing (.107" ID x 3/16" OD Blue) (RPI Part #RPT941)

360° Swivel Action!

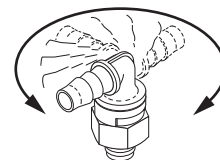

RPI Part #RPF978
OEM Part # (No OEM Part # Available)



SWIVEL ELBOW (1/8" BARB x #10-32 MALE)

- 2 per package; Black Nylon®
- Also available: Flat Washer (Nylon) (RPI Part #ADW038)
- See **Service Tip** above
- Fits:** Solenoid Valve, #10-32 Female Ports

RPI Part #RPF976
OEM Part # (No OEM Part # Available)



MALE CONNECTOR (3/16" PUSH-IN x #10-32 MALE)

- 2 per package; Nickel plated brass
- Note: This fitting has an internal hex and will require a 3/32" Hex Key for installation.
- See **Service Tip** above
- Fits:** Solenoid Valve to Water Source

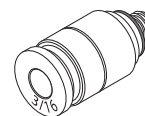

TRANSISTOR, FUSES & POWER CORDS

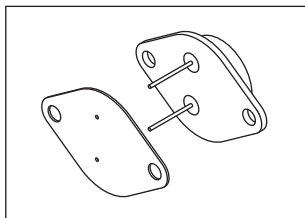

RPI Part #DST014
OEM Part #574335001, 61350

TRANSISTOR

- Includes: Darlington transistor and insulation gasket
- Fits:** Electrical Chassis

RPI Part #RPF922
OEM Part #60537

FUSE (630MA, 250V) 5MM x 20MM TIME DELAY

- 5 per package; Type: Glass
- For use with 220V units
- Fits:** PCB Fuse Holder

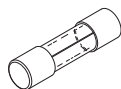

RPI Part #RPF524
OEM Part #557034018

FUSE (1/8A, 250V) 5MM x 20MM TIME DELAY

- 5 per package; Type: Glass
- For use with 120V units
- Fits:** Power Entry Module

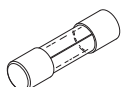

- Color: Gray
- Plug: NEMA 5-15P
- Connector: EN60320-C13
- Also available: Cord Strap (White 6") (RPI Part #RPS672)
- Fits:** Power Input Module

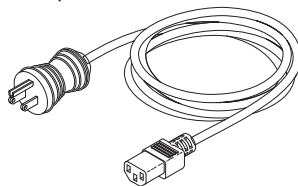

RPI Part #RPC557
OEM Part #554102003

HOSPITAL GRADE POWER CORD (13A @ 125VAC, 8 ft.)

- Length: 8 ft. • 16/3 SJT, 105°C

RPI Part #RPC869
OEM Part # (No OEM Part # Available)

HOSPITAL GRADE POWER CORD (13A @ 125VAC, 3 ft.)

- Length: 3 ft. • 16/3 SJT, 105°C

RPI Part #RPC868
OEM Part # (No OEM Part # Available)

HOSPITAL GRADE POWER CORD (13A @ 125VAC, 1.5 ft.)

- Length: 1.5 ft. • 16/3 SJT, 105°C

RPI Part #DSF048
OEM Part #623072001



UNION CONNECTOR (3/16" PUSH-IN)

- Includes all parts as shown
- See **Service Tip** above
- Fits:** Chassis Bracket to 3/16" OD Water Supply Line

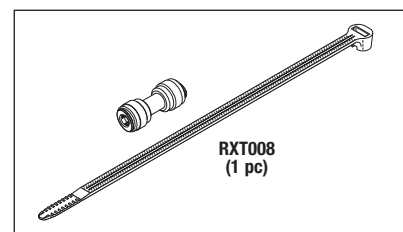

RPI Part #RXT008
OEM Part #712-00004



CABLE TIE (.270" W x 8.75" lg. WHITE)

- 25 per package
- Bundle dia.: .16" min/2.00" max
- Fits:** Union Connector 3/16" to Chassis Bracket

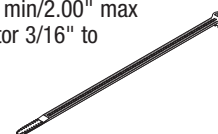

Cavitron® Models: BOBCAT® 25 KHz - G115, BOBCAT® Pro - G130, DualSelect™ Dispensing System - G118, JET Plus™ - G132, JET Plus™ - G137, JET with SPST™ - G120, Plus™ Scaler - G131, Plus™ Scaler - G136, Prophy-JET® Air Polishing System - G122, Prophy-Jet® - G138, Select™ Scaler 25K - G121, Select™ SPST™ 30K - G124, SPS™ Surface Mount Ultrasonic Scaler - G98a, SPS™ Ultrasonic Scaler - G119, & Touch™ Scaler - G1000

Complete list of RPI Parts to fit Dentsply Cavitron® Ultrasonic Scalers!

RPI Part #	OEM Part #	Description	BOBCAT® 25 KHz - G115	BOBCAT® Pro - G130	DualSelect™ Dispensing System - G118	JET Plus™ - G132	JET Plus™ - G137	JET with SPST™ - G120	Plus™ Scaler - G131	Plus™ Scaler - G136	Prophy-JET® Air Polishing System - G122	Prophy-Jet® - G138	Select™ Scaler 25K - G121	Select™ SPST™ 30K - G124	SPS™ Surface Mount Ultrasonic Scaler - G98a	SPS™ Ultrasonic Scaler - G119	Touch™ Scaler - G1000
ADB012	No OEM Part # Available	Barb - 10/pkg															
ADC034	No OEM Part # Available	Uni-Clamp - 20/pkg															
ADC035	No OEM Part # Available	Sleeve Clamp - 20/pkg															
ADC058	No OEM Part # Available	Cord Clip - 10/pkg															
ADS032	No OEM Part # Available	Polyflo Sleeve/Ferrule (1/4") - 25/pkg															
ADW038	No OEM Part # Available	Flat Washer - 50/pkg															
DSA002	60367	Duckbill Filter Assembly															
DSA008	63856	Hose Assembly & Filter (Air)															
DSA046	No OEM Part # Available	Water Supply Hose Assembly (Braided)															
DSA047	90125	Water Supply Line Assembly															
DSC017	No OEM Part # Available	Coil (Solenoid Valve)															
DSF005	90158	Disc Filter (Water) - 10/pkg															
DSF012	565162005	Foot Control															
DSF013	565138002, 565138003	Foot Control															
DSF039	77885	Foot Control															
DSF040	565162002	Foot Control															
DSF042	565162006	Foot Control															
DSF048	623072001	Union Connector (3/16" Push-In)															
DSH003	60388	Water Hose (Braided Blue)															
DSH009	80786	Air Hose (Braided Gray)															
DSK001	90172	Retrofit Water Filter Kit															
DSK016	No OEM Part # Available	Solenoid Valve Repair Kit															
DSK018	60367 (complete Assy.)	Repair Kit (Duckbill Filter Assembly)															
DSK020	No OEM Part # Available	Solenoid Valve Repair Kit															
DSK021	No OEM Part # Available	Water Filter Kit															
DSK022	81167	Check Valve Kit															
DSL024	No OEM Part # Available	Label (Air) - 3/pkg															
DSL025	No OEM Part # Available	Label (Water) - 3/pkg															
DSL026	No OEM Part # Available	Label (Caution) - 3/pkg															
DST014	574335001, 61350	Transistor															
DSV006	571070003	Solenoid Valve (Water)															
DSV011	629194002	Solenoid Valve (Pinch)															
DSV015	571070002	Solenoid Valve (Water)															
DSV019	81258	Solenoid Valve (Water)															
DSV023	629211001	Check Valve															
DSV027	629202001	Needle Valve (Water)															
RPA915	90088	Air Filter Assembly															
RPC557	554102003	Hospital Grade Power Cord (13A @ 125VAC, 8 ft.)															
RPC868	554102003	Hospital Grade Power Cord (13A @ 125VAC, 1.5 ft.)															
RPC869	554102003	Hospital Grade Power Cord (13A @ 125VAC, 3 ft.)															
RPE916	No OEM Part # Available	Filter Element															
RPF524	557034018	Fuse (1/8A, 250V) 5mm x 20mm Time Delay - 5/pkg															
RPF883	No OEM Part # Available	Polyflo Nut (1/4" Brass) - 5/pkg															
RPF907	621066001	Luer Lock (Male x 5/32" Barb) - 10/pkg															
RPF908	621065001	Luer Lock (Female x 5/32" Barb) - 10/pkg															
RPF913	No OEM Part # Available	Polyflo Fitting (1/4" Tube x 1/8" MPT) - 5/pkg															
RPF914	No OEM Part # Available	Adaptor (1/16" Barb x 1/8" MPT) - 5/pkg															
RPF917	No OEM Part # Available	Polyflo Fitting (1/4" Tube x #10-32 Male) - 5/pkg															
RPF918	79521	Quick Disconnect, Male (1/4" Poly Auto Shut-Off)															
RPF920	No OEM Part # Available	Quick Disconnect, Female (Panel Mount 1/4" Poly)															
RPF922	60537	Fuse (630MA, 250V) 5mm x 20mm Time Delay - 5/pkg															
RPF923	63827	Adaptor Elbow (1/16" Barb X 1/8" MPT) - 5/pkg															
RPF942	623064002	Cross Fitting (1/8" Barb x #10-32 Male) - 5/pkg															
RPF944	621068001	Adaptor Fitting (1/16" Barb x 1/8" Barb) - 10/pkg															
RPF948	No OEM Part # Available	Adaptor (1/16" Barb x 1/8" MPT) - 5/pkg															
RPF953	No OEM Part # Available	Polyflo Nut (1/4" Chrome) - 5/pkg															
RPF974	No OEM Part # Available	Luer Lock (Male x 1/8" Barb) - 10/pkg															
RPF975	621065001	Luer Lock (Female x 1/8" Barb) - 10/pkg															
RPF976	No OEM Part # Available	Male Connector (3/16" Push-In x #10-32 Male) - 2/pkg															
RPF977	6390253	Elbow Fitting (1/16" Barb x #10-32 Male) - 10/pkg															
RPF978	No OEM Part # Available	Swivel Elbow (1/8" Barb x #10-32 Male) - 2/pkg															
RPO304	No OEM Part # Available	O-Ring - 12/pkg															
RPO342	62351	O-Ring (Black) - 12/pkg															
RPO924	62605	O-Ring (Green) - 12/pkg															
RPS672	No OEM Part # Available	Cord Strap (White 6") - 3/pkg															
RPT296	No OEM Part # Available	Universal Sleeve Tool															
RPT909	No OEM Part # Available	Braided Tubing (1/4" OD Blue) - per ft.															
RPT910	No OEM Part # Available	Braided Tubing (1/4" OD Blue) (Box of 100 ft.)															
RPT911	No OEM Part # Available	Braided Tubing (1/4" OD Gray) - per ft.															
RPT912	No OEM Part # Available	Braided Tubing (1/4" OD Gray) (Box of 100 ft.)															
RPT927	No OEM Part # Available	Tubing (.160" ID x 1/4" OD Blue) - per ft.															
RPT940	61963	Tubing (1/16" ID x 1/8" OD Clear Polyurethane) - per ft.															
RPT941	625075001	Tubing (.107" ID x 3/16" OD Blue) - per ft.															
RPT973	625072001	Tubing (1/16" ID x 3/16" OD Black) - per ft.															
RPT999	No OEM Part # Available	Tubing (.160" ID x 1/4" OD Blue) (Box of 100 ft.)															
RXT001	625075001	Tubing (.107" ID x 3/16" OD Blue) (Box of 100 ft.)															
RXT008	712-00004	Cable Tie (.270" W x 8.75" Lg. White) - 25/pkg															
RXT016	61631	Pinch Tubing (1/16" ID x 1/8" OD Red) - per ft.															

Call Us Toll-Free Monday-Friday, 8:00 AM-4:30 PM (Pacific Time), (800) 221-9723

Dental Equipment

Cavitron® Models: BOBCAT® 25 KHz - G115, BOBCAT® Pro - G130, DualSelect™ Dispensing System - G118, JET Plus™ - G132, JET Plus™ - G137, JET with SPST™ - G120, Plus™ Scaler - G131, Plus™ Scaler - G136, Prophy-JET® Air Polishing System - G122, Prophy-Jet® - G138, Select™ Scaler 25K - G121, Select™ SPS™ 30K - G124, SPS™ Surface Mount Ultrasonic Scaler - G98a, SPS™ Ultrasonic Scaler - G119, & Touch™ Scaler - G1000

NOTES:

Lined area for notes with horizontal ruling lines.

SECTION

4

PAGE

1609

UPDATED
10/18

RPI Part #VPC069
OEM Part # See Chart Below



SOLIDS COLLECTOR (3/4")

- Ports: 3/4" FPT
- Material: Black plastic body with clear plastic bowl
- Includes: Bowl, Bowl Gasket (RPI Part #VPG080) and Screen (50 Mesh) (RPI Part #VPS076)

Fits: Manifold Assembly

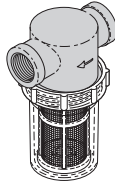

RPI Part #VPC070
OEM Part # See Chart Below



SOLIDS COLLECTOR (1")

- Ports: 1" FPT
- Material: Black plastic body with clear plastic bowl
- Includes: Bowl, Bowl Gasket (RPI Part #VPG081) and Screen (20 Mesh) (RPI Part #VPS079)

Fits: Manifold Assembly

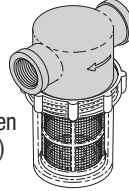

RPI Part #VPC071
OEM Part # See Chart Below



SOLIDS COLLECTOR (1-1/4")

- Ports: 1-1/4" FPT
- Material: Black plastic body with clear plastic bowl
- Includes: Bowl, Bowl Gasket (RPI Part #VPG081) and Screen (20 Mesh) (RPI Part #VPS079)

Fits: Manifold Assembly

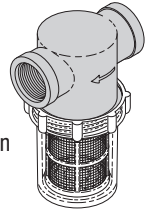

RPI Part #VPS076
OEM Part # See Chart Below



SCREEN (50 MESH)

- Material: Stainless steel screen; Blue plastic cage
- Size: 1.73" OD x 3.77" lg.

Fits: Solids Collector (3/4")



RPI Part #VPS077
OEM Part # See Chart Below



SCREEN (20 MESH)

- Material: Stainless steel screen; Red plastic cage
- Size: 1.73" OD x 3.77" lg.

Fits: Solids Collector (3/4")



RPI Part #VPG080
OEM Part # See Chart Below



BOWL GASKET

- 3 per package
- Material: Buna N (Nitrile)
- Size: 2.23" OD x .13" Square

Fits: Solids Collector Assembly (3/4")



RPI Part #VPS078
OEM Part # See Chart Below



SCREEN (50 MESH)

- Material: Stainless steel screen, Blue plastic cage
- Size: 2.47" OD x 4.25" lg.

Fits: Solids Collector (1") and (1-1/4")

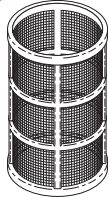

RPI Part #VPS079
OEM Part # See Chart Below



SCREEN (20 MESH)

- Material: Stainless steel screen; Red plastic cage
- Size: 2.47" OD x 4.25" lg.

Fits: Solids Collector (1") and (1-1/4")

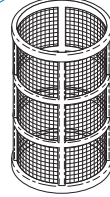

RPI Part #VPG081
OEM Part # See Chart Below



BOWL GASKET

- 3 per package
- Material: Buna N (Nitrile)
- Size: 3.13" OD x .13" Square

Fits: Solids Collector Assembly (1" & 1-1/4")



RPI Part #VPK072
OEM Part # See Chart Below



SOLIDS COLLECTOR REPLACEMENT KIT

- Includes all parts as shown

Fits: Solids Collector Assy. 3/4"

ALSO AVAILABLE BY THE CASE OF 12!

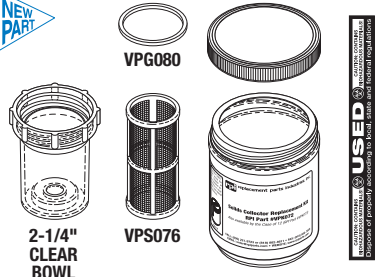

RPI Part #VPK074
OEM Part # See Chart Below



SOLIDS COLLECTOR REPLACEMENT KIT

- Includes all parts as shown

Fits: Solids Collector Assy. 1" and 1-1/4"

ALSO AVAILABLE BY THE CASE OF 8!

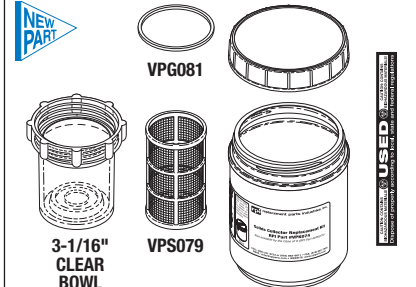

RPI Part #VPK073
OEM Part # See Chart Below

SOLIDS COLLECTOR REPLACEMENT KIT (CASE OF 12)

- Includes: (12) Solids Collector Replacement Kits (RPI Part #VPK072)

RPI Part #VPK075
OEM Part # See Chart Below

SOLIDS COLLECTOR REPLACEMENT KIT (CASE OF 8)

- Includes: (8) Solids Collector Replacement Kits (RPI Part #VPK074)

RPI PART #	DESCRIPTION	AIR TECHNIQUES	APOLLO/MIDMARK®	DENTALEZ®/CUSTOM AIR/RAMVAC	MATRIX/MIDMARK®	MIDMARK®	TECH WEST
VPC069	Solids Collector (3/4")	55862	PCC50705	64545040	62937301	62937301	VFA-40
VPC070	Solids Collector (1")		PCV50706	64501940		77005147	
VPC071	Solids Collector (1-1/4")	55612	PCV50708		77005155	77005155	
VPG080	Bowl Gasket - 3/pkg	55625		No OEM Part # Available	77007018	77007018	VFG-100
VPG081	Bowl Gasket - 3/pkg	No OEM Part # Available	MRP70936	No OEM Part # Available	77005158	77005158	
VPK072	Solids Collector Replacement Kit	55880	AVA60001	No OEM Part # Available	77005167	77005167	VFB-100
VPK073	Solids Collector Replacement Kit (Case of 12)	No OEM Part # Available	No OEM Part # Available	No OEM Part # Available	77005177	77005177	No OEM Part # Available
VPK074	Solids Collector Replacement Kit	55094	AVA600012	64568122	77005180	77005180	
VPK075	Solids Collector Replacement Kit (Case of 8)	No OEM Part # Available	No OEM Part # Available	No OEM Part # Available	77005181 & 77005178	77005181 & 77005178	
VPS076	Screen (50 Mesh)	No OEM Part # Available	No OEM Part # Available	No OEM Part # Available	No OEM Part # Available	No OEM Part # Available	No OEM Part # Available
VPS077	Screen (20 Mesh)	No OEM Part # Available	No OEM Part # Available	No OEM Part # Available	No OEM Part # Available	No OEM Part # Available	No OEM Part # Available
VPS078	Screen (50 Mesh)	No OEM Part # Available	No OEM Part # Available	No OEM Part # Available	No OEM Part # Available	No OEM Part # Available	
VPS079	Screen (20 Mesh)	No OEM Part # Available	No OEM Part # Available	No OEM Part # Available	77005079	77005079	

Call Us Toll-Free Monday-Friday, 8:00 AM-4:30 PM (Pacific Time), (800) 221-9723

Dental Equipment

Air Techniques, Apollo/Midmark®, DentalEZ®/Custom Air/RamVac, Matrix/Midmark®, Midmark® & Tech West

Air Techniques, Apollo/Midmark®,
DentalEZ®/Custom Air/RamVac,
Matrix/Midmark®, Midmark® & Tech West

IDENTICAL VACUUM UNITS -

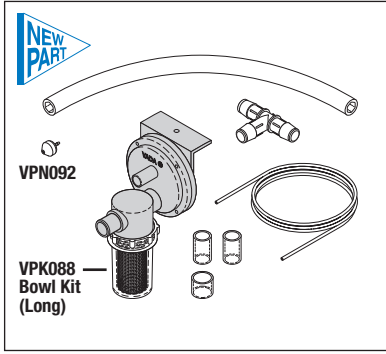

RPI Part #VPV083
OEM Part #4512266

CUSPIDOR DRAIN VALVE (VADA TRAP)

- Automatic drain for dental cuspidor
- Connects to central vacuum system and eliminates conventional plumbing drain
- Allows installation where a gravity drain is not available or practical
- Includes all parts as shown
- Included in: Sink Drain Valve Assembly (RPI Part #VPK082)

Fits: Dental Cuspidors
Models: All Vada Traps

Note: Adapts all OEM dental delivery cuspidors to a central vacuum line when there is not a normal gravity drain available.

RPI Part #VPN092

OEM Part #

(No OEM Part # Available)

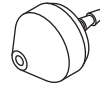

CLEAN OUT-NIPPLE

- Material: Black plastic tip with 1/16" barb
- Fits:** Vada Trap
Models: All Vada Traps

RPI Part #VPK088

OEM Part #

(No OEM Part # Available)



BOWL KIT (LONG)

- Includes all parts as shown
 - Bowl Height: 2.67" tall
- Fits:** Sink and Cuspidor Drain Valve Assemblies (Vada Trap) Serial Number 00001 and After
Models: All Vada Traps



RPI Part #VPK087

OEM Part #

(No OEM Part # Available)

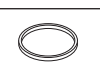

BOWL KIT (SHORT)

- Includes all parts as shown
 - Bowl Height: 1.34" tall
- Fits:** Sink and Cuspidor Drain Valve Assemblies Manufactured Before September 1997 and All Units Without Serial Numbers
Models: All Vada Traps



RPI Part #VPG091

OEM Part #

(No OEM Part # Available)



BOWL GASKET

- 3 per package
 - Material: Silicone rubber
 - Size: 1.43" OD x 1.28" ID x .11" thk
- Fits:** Sink and Cuspidor Drain Valve Assembly
Models: All Vada Traps

RPI Part #VPS090

OEM Part #

(No OEM Part # Available)



SCREEN (LONG)

- Size: 1" dia. x 2.62" lg.
 - Material: 20 Mesh stainless steel
- Fits:** Sink and Cuspidor Drain Valve Assemblies (Vada Trap) Serial #00001 and After
Models: All Vada Traps

RPI Part #VPS089

OEM Part #

(No OEM Part # Available)



SCREEN (SHORT)

- Size: 1" dia. x 1.34" lg.
 - Material: 20 Mesh stainless steel
- Fits:** Sink and Cuspidor Drain Valve Assemblies (Vada Trap) Manufactured Before September 1997 and All Units Without Serial Numbers
Models: All Vada Traps

RPI Part #VPA084

OEM Part # (No OEM Part # Available)

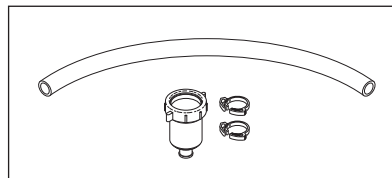

SINK ADAPTOR

- Connects to 1-1/2" sink drain tailpiece and reduces to 5/8" tubing connector to connect to vacuum system
- Includes all parts as shown
- Included in: Sink Drain Valve Assembly (RPI Part #VPK082)

Fits: Standard or Operator Sinks

Models: All Vada Traps

RPI Part #VPK082

OEM Part #45R062

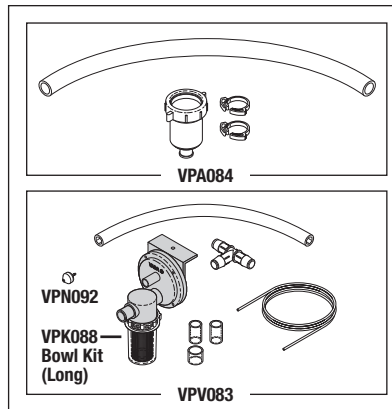

SINK DRAIN VALVE ASSEMBLY

- Automatic drain for standard or operator sink 1-1/2" tailpiece
- Connects to central vacuum system and eliminates conventional plumbing drain
- Allows installation where a gravity drain is not available or practical
- Includes: Sink Adapter (RPI Part #VPA084) and Cuspidor Drain Valve (RPI Part #VPV083)
- Also available: Diaphragm (RPI Part #VPD086) and Bowl Kit (Long) (RPI Part #VPK088)

Fits: Standard or Operator Sinks

Models: All Vada Traps

Note: Adapts all OEM sinks to a central vacuum line when there is not a normal gravity drain available.

RPI Part #VPD085

OEM Part #

(No OEM Part # Available)

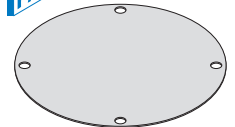

DIAPHRAGM

- Material: Silicone rubber
 - Size: 3" dia. with four mounting holes
- Fits:** Sink and Cuspidor Drain Valve Assemblies (Vada Trap) and Units Without Serial Numbers
Models: All Vada Traps

RPI Part #VPD086

OEM Part #

(No OEM Part # Available)

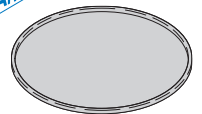

DIAPHRAGM

- Material: Silicone rubber
- Size: 2-9/16" dia. without mounting holes
- Also available: Sink Drain Valve Assembly (RPI Part #VPK082) and Cuspidor Drain Valve (RPI Part #VPV083)

Fits: Sink and Cuspidor Drain Valve Assemblies (Vada Trap) Serial Number 0001 and above (Including All Vada Traps Sold By RPI)
Models: All Vada Traps

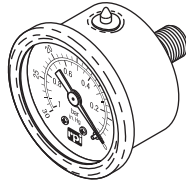

RPI Part #GOG046
OEM Part # See Chart Below

VACUUM GAUGE

- Size: 1-1/2" dia.
- Dual Scale: 0 to 30 In. Hg (0 to 1 Bar)
- Material: Stainless steel case and bezel
- Port: 1/8" MPT center back mount
- Fits:** Manifold Assembly



Liquid Filled!

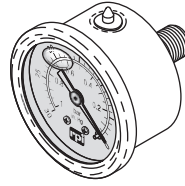

RPI Part #VPG044
OEM Part # See Chart Below

VACUUM GAUGE (LIQUID FILLED)

- Size: 1-1/2" dia.
- Dual Scale: 0 to 30 In. Hg (0 to 1 Bar)
- Material: Stainless steel case and bezel
- Port: 1/8" MPT center back mount
- Fits:** Manifold Assembly

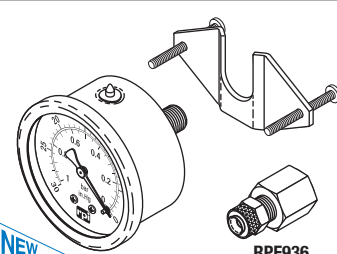

RPI Part #VPG094
OEM Part # See Chart Below

VACUUM GAUGE

- Size: 2.0" dia.
- Dual Scale: 0 to 30 In. Hg (0 to 1 Bar)
- Material: Stainless steel case and bezel
- Port: 1/4" MPT center back mount
- Includes all parts as shown
- Fits:** Manifold Assembly

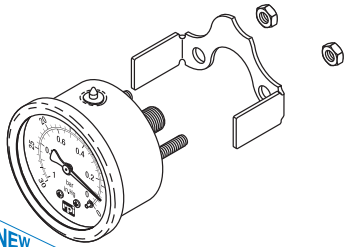

RPI Part #VPG045
OEM Part # See Chart Below

VACUUM GAUGE

- Size: 2.0" dia.
- Dual Scale: 0 to 30 In. Hg (0 to 1 Bar)
- Material: Stainless steel case and bezel
- Port: 1/8" MPT center back mount
- Includes all parts as shown
- Fits:** Manifold Assembly



Liquid Filled!

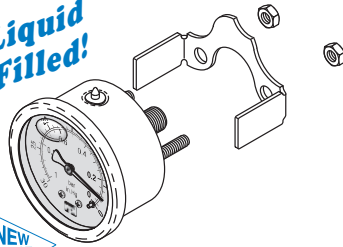

RPI Part #VPG046
OEM Part # See Chart Below

VACUUM GAUGE (LIQUID FILLED)

- Size: 2.0" dia.
- Dual Scale: 0 to 30 In. Hg (0 to 1 Bar)
- Material: Stainless steel case and bezel
- Port: 1/8" MPT center back mount
- Includes all parts as shown
- Fits:** Manifold Assembly

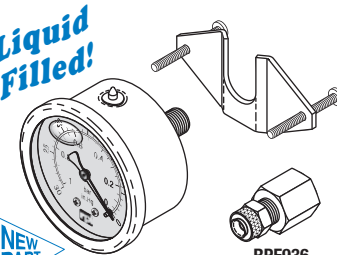

RPI Part #VPG095
OEM Part # See Chart Below

VACUUM GAUGE (LIQUID FILLED)

- Size: 2.0" dia.
- Dual Scale: 0 to 30 In. Hg (0 to 1 Bar)
- Material: Stainless steel case and bezel
- Port: 1/4" MPT center back mount
- Includes all parts as shown
- Fits:** Manifold Assembly

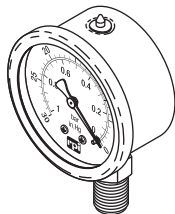

RPI Part #VPG047
OEM Part # See Chart Below

VACUUM GAUGE

- Size: 2.0" dia.
- Dual Scale: 0 to 30 In. Hg (0 to 1 Bar)
- Material: Stainless steel case and bezel
- Ports: 1/4" MPT bottom mount
- Fits:** Manifold Assembly



Liquid Filled!

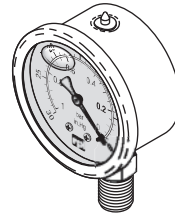

RPI Part #VPG048
OEM Part # See Chart Below

VACUUM GAUGE (LIQUID FILLED)

- Size: 2.0" dia.
- Dual Scale: 0 to 30 In. Hg (0 to 1 Bar)
- Material: Stainless steel case and bezel
- Port: 1/4" MPT bottom mount
- Fits:** Manifold Assembly



RPI Part #RPF936
OEM Part # See Chart Below

FEMALE CONNECTOR (1/4" POLY x 1/4" FPT)

- 2 per package
- Size: 1/4" Polyflo x 1/4" FPT
- Material: Brass
- Includes: Brass polyflo sleeve
- Fits:** Vacuum Gauge

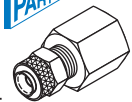

RPI PART #	DESCRIPTION	AIR TECHNIQUES	APOLLO/MIDMARK®	DENTALEZ®/CUSTOM AIR/RAMVAC	MATR/MIDMARK®	MIDMARK®	TECH WEST
GOG046	Vacuum Gauge	55616			62947800	62947800	
VPG044	Vacuum Gauge (Liquid Filled)	55616			62947800	62947800	
VPG045	Vacuum Gauge	55680					
VPG046	Vacuum Gauge (Liquid Filled)	55680					
VPG047	Vacuum Gauge		014-0550-00	64568188			VPG-100
VPG048	Vacuum Gauge (Liquid Filled)		014-0550-00	64568188			VPG-100
VPG094	Vacuum Gauge			64568134			
VPG095	Vacuum Gauge (Liquid Filled)			64568134			
RPF936	Female Connector (1/4" Poly x 1/4" FPT) - 2/pkg			No OEM Part # Available			

Call Us Toll-Free Monday-Friday, 8:00 AM-4:30 PM (Pacific Time), (800) 221-9723

Dental Equipment

Air Techniques, Apollo/Midmark®, DentalEZ®/Custom Air/RamVac, Matrix/Midmark®, Midmark® & Tech West

Air Techniques, Apollo/Midmark®, DentalEZ®/Custom Air/RamVac, Matrix/Midmark®, Midmark® & Tech West

DENTAL VACUUM UNITS -

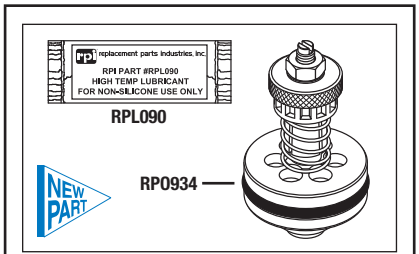

RPI Part #VPV059
OEM Part # See Chart Below
VACUUM RELIEF VALVE
 • Includes all parts as shown
 • Also available: Filter Element and Screen (RPI Part #VPE064)
Fits: Manifold Assembly

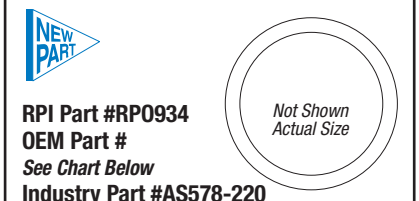

RPI Part #RPO934
OEM Part # See Chart Below
Industry Part #AS578-220
O-RING
 • 3 per package
 • Size: 1.359" ID x 1.637" OD x .139" C/S
 • Material: Buna-N (Nitrile), 70 Duro
Fits: Vacuum Relief Valve

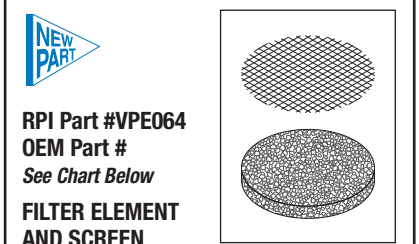

RPI Part #VPE064
OEM Part # See Chart Below
FILTER ELEMENT AND SCREEN
 • Size: 1.88" OD x .25" thk. foam filter
 • Includes: PM sticker
Fits: Vacuum Relief Valve Assembly

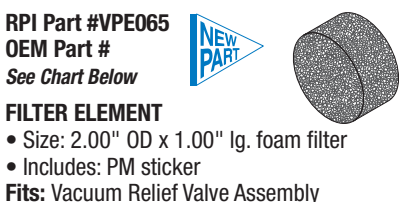

RPI Part #VPE065
OEM Part # See Chart Below
FILTER ELEMENT
 • Size: 2.00" OD x 1.00" lg. foam filter
 • Includes: PM sticker
Fits: Vacuum Relief Valve Assembly

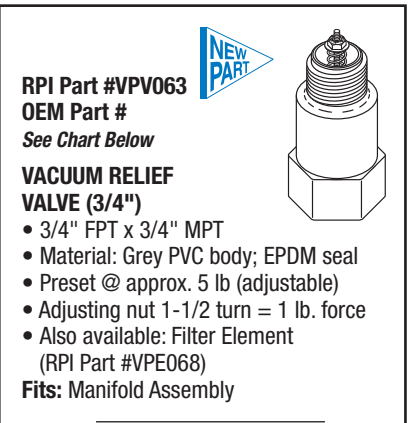

RPI Part #VPV063
OEM Part # See Chart Below
VACUUM RELIEF VALVE (3/4")
 • 3/4" FPT x 3/4" MPT
 • Material: Grey PVC body; EPDM seal
 • Preset @ approx. 5 lb (adjustable)
 • Adjusting nut 1-1/2 turn = 1 lb. force
 • Also available: Filter Element (RPI Part #VPE068)
Fits: Manifold Assembly

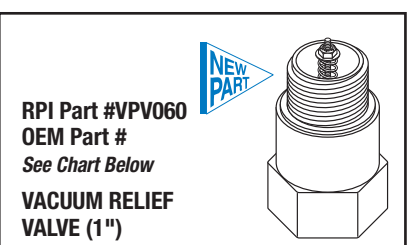

RPI Part #VPE068
OEM Part # See Chart Below
FILTER ELEMENT AND SCREEN
 • Size: .88" OD x .25" lg.
 • Includes: PM sticker
Fits: Vacuum Relief Valve Assembly

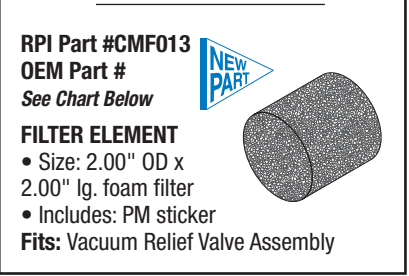

RPI Part #VPV060
OEM Part # See Chart Below
VACUUM RELIEF VALVE (1")
 • 1" FPT x 1" MPT
 • Material: White PVC body; EPDM seal
 • Preset @ approx. 5 lb (adjustable)
 • Adjusting nut 1-1/2 turn = 1 lb. force
 • Also available: Foam Element (RPI Part #CMF013)
Fits: Manifold Assembly

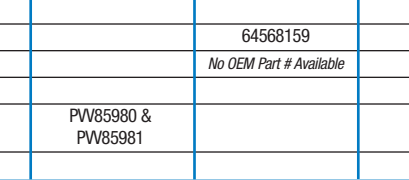

RPI Part #CMF013
OEM Part # See Chart Below
FILTER ELEMENT
 • Size: 2.00" OD x 2.00" lg. foam filter
 • Includes: PM sticker
Fits: Vacuum Relief Valve Assembly

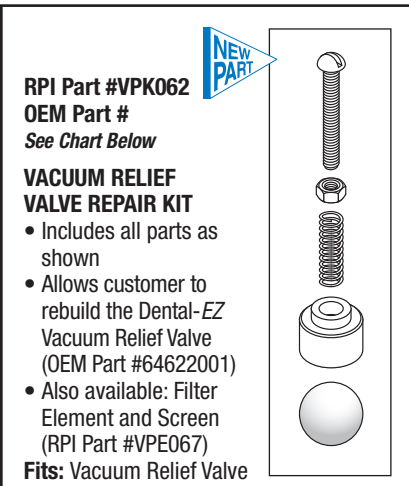

RPI Part #VPK062
OEM Part # See Chart Below
VACUUM RELIEF VALVE REPAIR KIT
 • Includes all parts as shown
 • Allows customer to rebuild the Dental-EZ Vacuum Relief Valve (OEM Part #64622001)
 • Also available: Filter Element and Screen (RPI Part #VPE067)
Fits: Vacuum Relief Valve

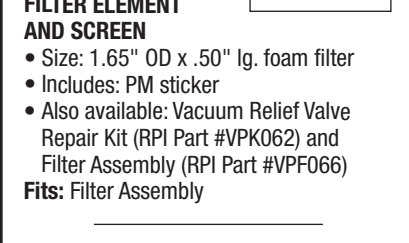

RPI Part #VPE067
OEM Part # See Chart Below
FILTER ELEMENT AND SCREEN
 • Size: 1.65" OD x .50" lg. foam filter
 • Includes: PM sticker
 • Also available: Vacuum Relief Valve Repair Kit (RPI Part #VPK062) and Filter Assembly (RPI Part #VPF066)
Fits: Filter Assembly

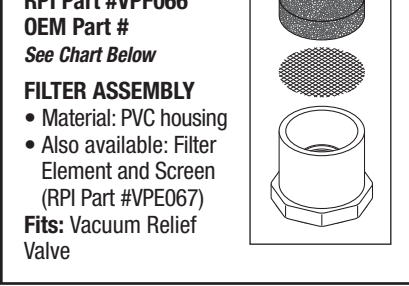

RPI Part #VPF066
OEM Part # See Chart Below
FILTER ASSEMBLY
 • Material: PVC housing
 • Also available: Filter Element and Screen (RPI Part #VPE067)
Fits: Vacuum Relief Valve

RPI PART #	DESCRIPTION	AIR TECHNIQUES	APOLLO/MIDMARK®	DENTALEZ®/CUSTOM AIR/RAMVAC	MATRIX/MIDMARK®	MIDMARK®	TECH WEST
CMF013	Filter Element		20207400 & 202047500				
RP0934	O-ring - 3/pkg	No OEM Part # Available					
VPE064	Filter Element and Screen	55713					
VPE065	Filter Element				62935604	62935604	
VPE067	Filter Element and Screen			64568145			
VPE068	Filter Element and Screen						No OEM Part # Available
VPF066	Filter Assembly			64568159			
VPK062	Vacuum Relief Valve Repair Kit			No OEM Part # Available			
VPV059	Vacuum Relief Valve	55865					
VPV060	Vacuum Relief Valve (1")		PVW85980 & PVW85981				
VPV063	Vacuum Relief Valve (3/4")						VRV-100

RPI Part #VPV057

OEM Part # See Chart Below

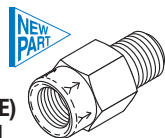

CHECK VALVE (1/4" IN-LINE)

- Cracking Pressure: 1.0 PSI
 - Ports: 1/4" FPT Inlet x 1/4" MPT Outlet
 - Material: Brass body, Buna-N (Nitrile) seal
- Fits:** Manifold Assembly

RPI Part #VPV058

OEM Part #

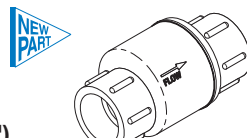

CHECK VALVE (3/4")

- Ports: 3/4" Slip x 3/4" Slip Schedule 40
 - Material: White PVC plastic
- Fits:** Manifold Assembly



RPI Part #VPG039

OEM Part # See Chart Below

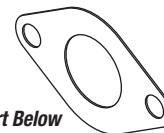

MANIFOLD GASKET

Fits: Manifold Assembly

RPI Part #VPV055

OEM Part #

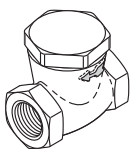

See Chart Below

CHECK VALVE (3/8")

- Ports: 3/8" FPT
 - Material: Bronze body
 - The RPI Check Valve is a rebuildable valve with a Buna-N (Nitrile) seal - It's the RPI Advantage!
 - Also available: Check Valve Repair Kit (RPI Part #VPK050)
- Fits:** Manifold Assembly

RPI Part #VPV051

OEM Part #

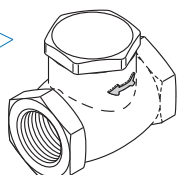

See Chart Below

CHECK VALVE (3/4")

- Ports: 3/4" FPT
 - Material: Bronze body
 - The RPI Check Valve is a rebuildable valve with a Buna-N (Nitrile) seal - It's the RPI Advantage!
 - Also available: Check Valve Repair Kit (RPI Part #VPK052)
- Fits:** Manifold Assembly



RPI Part #VPG040

OEM Part # See Chart Below

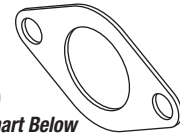

MANIFOLD GASKET

Fits: Manifold Assembly

RPI Part #VPV049

OEM Part #

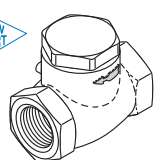

See Chart Below

CHECK VALVE (1/2")

- Ports: 1/2" FPT
 - Material: Bronze body
 - The RPI Check Valve is a rebuildable valve with a Buna-N (Nitrile) seal - It's the RPI Advantage!
 - Also available: Check Valve Repair Kit (RPI Part #VPK050)
- Fits:** Manifold Assembly

RPI Part #VPK052

OEM Part # See Chart Below

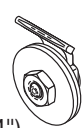

CHECK VALVE REPAIR KIT (3/4")

- Material: Buna-N (Nitrile) seat
- Fits: Only Fits** RPI's Check Valve (3/4") (RPI Part #VPV051)



RPI Part #VPG041

OEM Part # See Chart Below

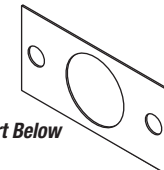

MANIFOLD GASKET

Fits: Manifold Assembly

RPI Part #VPK050

OEM Part # See Chart Below



CHECK VALVE REPAIR KIT (1/2" & 3/8")

- Material: Buna-N (Nitrile) seal
- Fits: Only Fits** Check Valve (1/2") (RPI Part #VPV049) and Check Valve (3/8") (RPI Part #VPV055)

RPI Part #VPV053

OEM Part #

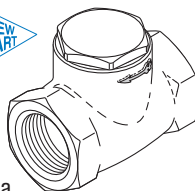

See Chart Below

CHECK VALVE (1")

- Ports: 1" FPT
 - Material: Bronze body
 - The RPI Check Valve is a rebuildable valve with a Buna-N (Nitrile) seal - It's the RPI Advantage!
 - Also available: Check Valve Repair Kit (RPI Part #VPK054)
- Fits:** Manifold Assembly



RPI Part #VPG042

OEM Part # See Chart Below

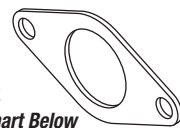

MANIFOLD GASKET

Fits: Manifold Assembly

RPI Part #VPK054

OEM Part # See Chart Below



CHECK VALVE REPAIR KIT (1")

- Material: Buna-N (Nitrile) seat
- Fits: Only Fits** RPI's Check Valve (1") (RPI Part #VPV053)



RPI Part #VPG043

OEM Part # See Chart Below

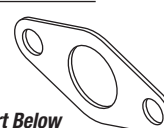

MANIFOLD GASKET

Fits: Manifold Assembly

RPI PART #	DESCRIPTION	AIR TECHNIQUES	APOLLO/MIDMARK®	DENTAL EZ®/CUSTOM AIR/RAMVAC	MATRX/MIDMARK®	MIDMARK®	TECH WEST
VPG039	Manifold Gasket	55617					
VPG040	Manifold Gasket				61203200	61203200	
VPG041	Manifold Gasket		MMS71167				
VPG042	Manifold Gasket			64568137			
VPG043	Manifold Gasket						MG-100
VPG093	Manifold Gasket		MMS71165				
VPK050	Check Valve Repair Kit (1/2" & 3/8")		No OEM Part # Available	No OEM Part # Available			
VPK052	Check Valve Repair Kit (3/4")	No OEM Part # Available	No OEM Part # Available	No OEM Part # Available	No OEM Part # Available	No OEM Part # Available	
VPK054	Check Valve Repair Kit (1")		No OEM Part # Available	No OEM Part # Available			
VPV049	Check Valve (1/2")		PW50656				
VPV051	Check Valve (3/4")	56105	PW50657	64568191	770002003	770002003	
VPV053	Check Valve (1")		PW50658	64568193			
VPV055	Check Valve (3/8")			64622311			
VPV057	Check Valve (1/4" In-Line)	56056					
VPV058	Check Valve (3/4")						CVF-750

Call Us Toll-Free Monday-Friday, 8:00 AM-4:30 PM (Pacific Time), (800) 221-9723

Dental Equipment

Air Techniques, Apollo/Midmark®, DentalEZ®/Custom Air/RamVac, Matrix/Midmark®, Midmark® & Tech West

RPI Part #VPA001
OEM Part #64568196



WATER CONTROL ASSEMBLY (1 HP)

- Fully assembled for easy installation
- 0.5 GPM flow
- 24VAC solenoid valve
- Includes all parts as shown

Fits: 1 HP Wet Ring Vacuum System

Models: DentalEZ/Custom Air/
RamVac: CV-101 FS

See our website
www.rpiparts.com
for an Exploded View of
the Water Control Assembly!

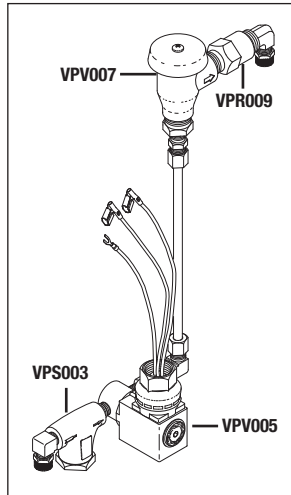

RPI Part #VPA002
OEM Part #64568197



WATER CONTROL ASSEMBLY (2 HP)

- Fully assembled for easy installation
- 1.0 GPM flow
- 24VAC solenoid valve
- Includes all parts as shown

Fits: 2 HP Wet Ring Vacuum Systems

Models: DentalEZ/Custom Air/
RamVac: CV-102 FS

See our website
www.rpiparts.com
for an Exploded View of
the Water Control Assembly!

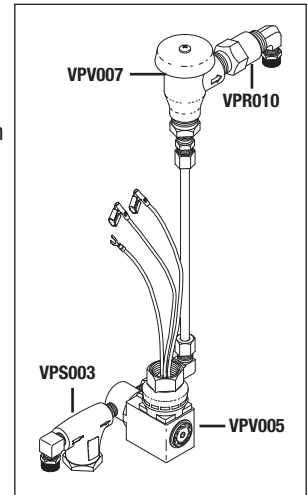

With RPI, now you have a choice to replace the Strainer or just the Strainer Element – It's the RPI Advantage!

RPI Part #VPS003
OEM Part # See Chart Below

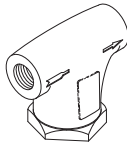

STRAINER (WATER-1/8")

- Material: Lead free cast copper silicon alloy
- Ports: 1/8" FPT
- Also available: Strainer Element (RPI Part #VPE004)
- Included in: Water Control Assembly (RPI Part #VPA001 & VPA002)

Fits: Water Control Assembly

STRAINER ELEMENT

RPI Part #VPE004
OEM Part # See Chart Below



STRAINER ELEMENT

- Material: 40 mesh stainless steel
- Includes all parts as shown
- Also available: Strainer (Water-1/8") (RPI Part #VPS003)

Fits: Water Control Assembly



SEALING
WASHER

RPI Part #VPS011
OEM Part # See Chart Below

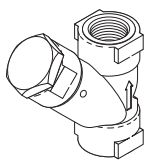

STRAINER (WATER-1/4")

- Material: Plastic
- Ports: 1/4" FPT
- Also available: Strainer Element (RPI Part #VPE012)

Fits: Water Control Assembly

STRAINER ELEMENT

RPI Part #VPE012
OEM Part # See Chart Below



STRAINER ELEMENT

- Material: 100 mesh stainless steel
- Includes all parts as shown
- Also available: Strainer (Water-1/4") (RPI Part #VPS011)

Fits: Water Control Assembly



RP0318

RPI Part #VPS013
OEM Part # See Chart Below

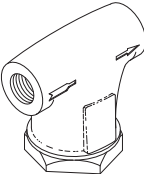

STRAINER (WATER-1/4")

- Material: Lead free cast copper silicon alloy
- Ports: 1/4" FPT
- Also available: Strainer Element (RPI Part #VPE014)

Fits: Water Control Assembly

STRAINER ELEMENT

RPI Part #VPE014
OEM Part # See Chart Below



STRAINER ELEMENT

- Material: 60 mesh stainless steel
- Includes all parts as shown
- Also available: Strainer (Water-1/4") (RPI Part #VPS013)

Fits: Water Control Assembly



RP0325

RPI PART #	DESCRIPTION	AIR TECHNIQUES	APOLLO/MIDMARK®	DENTALEZ®/CUSTOM AIR/RAMVAC	MATRIX/MIDMARK®	MIDMARK®	TECH WEST
VPE004	Strainer Element	No OEM Part # Available		No OEM Part # Available			No OEM Part # Available
VPE012	Strainer Element					No OEM Part # Available	
VPE014	Strainer Element	No OEM Part # Available	No OEM Part # Available		No OEM Part # Available		
VPS003	Strainer (Water-1/8")	55526		64568135 (includes fittings)			No OEM Part # Available
VPS011	Strainer (Water-1/4")					65962000	
VPS013	Strainer (Water-1/4")	55909	PCB50960		77005145		

FAX: (818) 882-7028 • E-MAIL: order@rpiparts.com • WEBSITE: www.rpiparts.com

With RPI, now you have a choice to replace the Solenoid Valve or repair it with one of our exclusive Kits – It's the RPI Advantage!

RPI Part #VPV005

OEM Part # See Chart Below

SOLENOID VALVE ASSEMBLY

- Ports: 1/8" FPT; 2-way; N.O.
- 24VAC, 60Hz., 8.5W; 18" lg. wires
- Material: Stainless steel body; Viton seals
- Includes all parts as shown
- Included in: Water Control Assembly (RPI Part #'s VPA001 & VPA002)

Fits: Water Control Assembly

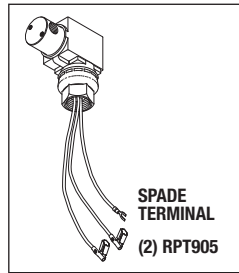

REPAIR KIT

RPI Part #VPK006

OEM Part # See Chart Below

SOLENOID VALVE REPAIR KIT

- Includes all parts as shown
- Also available: Solenoid Valve Assembly (RPI Part #'s VPV005, VPV015 & VPV038)

Fits: Solenoid Valve Assembly

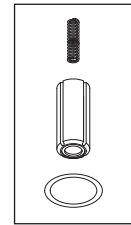

RPI Part #VPV015

OEM Part # See Chart Below

SOLENOID VALVE ASSEMBLY

- Ports: 1/8" FPT; 2-way; N.C.
- 120VAC, 60Hz., 8.5W; 1/4" Tabs
- Material: Stainless steel body; Viton seals

Fits: Water Control Assembly

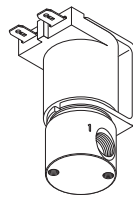

REPAIR KIT

RPI Part #VPK006

OEM Part # See Chart Below

SOLENOID VALVE REPAIR KIT

- Includes all parts as shown
- Also available: Solenoid Valve Assembly (RPI Part #'s VPV005, VPV015 & VPV038)

Fits: Solenoid Valve Assembly

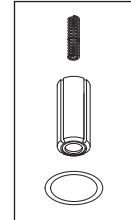

RPI Part #VPV038

OEM Part # See Chart Below

SOLENOID VALVE ASSEMBLY

- Ports: 1/8" FPT; 2-way; N.C.
- 220VAC, 50Hz., 8.5W; 1/4" Tabs
- Material: Stainless steel body; Viton seals

Fits: Water Control Assembly

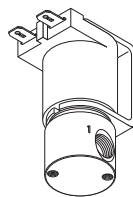

REPAIR KIT

RPI Part #VPK006

OEM Part # See Chart Below

SOLENOID VALVE REPAIR KIT

- Includes all parts as shown
- Also available: Solenoid Valve Assembly (RPI Part #'s VPV005, VPV015 & VPV038)

Fits: Solenoid Valve Assembly

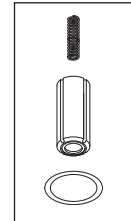

RPI Part #VPV017

OEM Part # See Chart Below

SOLENOID VALVE ASSEMBLY

- Ports: 1/8" FPT; 2-way; N.C.
- 120VAC, 60Hz., 7W; 12" lg. wires
- Material: Stainless steel body; Nitrile (Buna-N) seals
- Includes all parts as shown

Fits: Water Control Assembly

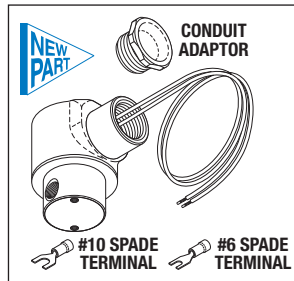

REPAIR KIT

RPI Part #VPK018

OEM Part # See Chart Below

SOLENOID VALVE REPAIR KIT

- Includes all parts as shown
- Also available: Solenoid Valve Assembly (RPI Part #'s VPV017 & VPV036)

Fits: Water Control Solenoid Valve

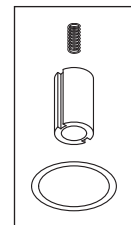

Note: When replacing the Solenoid Valve (RPI Part #VPV017) in units that require the Upgrade Kit (OEM Part #55020), see our website www.rpiparts.com for additional fittings and hardware parts available.

RPI Part #VPV036

OEM Part # See Chart Below

SOLENOID VALVE ASSEMBLY

- Ports: 1/8" FPT; 2-way; N.C.
- 240VAC, 60Hz., 7W; 12" lg. wires
- Material: Stainless steel body; Nitrile (Buna-N) seals
- Includes all parts as shown

Fits: Water Control Assembly

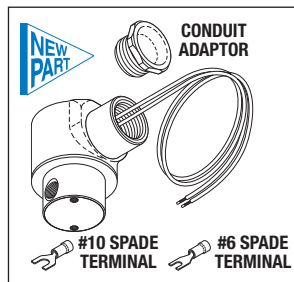

REPAIR KIT

RPI Part #VPK018

OEM Part # See Chart Below

SOLENOID VALVE REPAIR KIT

- Includes all parts as shown
- Also available: Solenoid Valve Assembly (RPI Part #'s VPV017 & VPV036)

Fits: Water Control Solenoid Valve

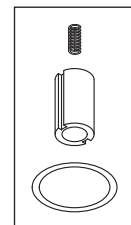

RPI PART #	DESCRIPTION	AIR TECHNIQUES	APOLLO/MIDMARK®	DENTALEZ®/CUSTOM AIR/RAMVAC	MATR/MIDMARK®	MIDMARK®
VPK006	Solenoid Valve Repair Kit		No OEM Part # Available	No OEM Part # Available	No OEM Part # Available	No OEM Part # Available
VPK018	Solenoid Valve Repair Kit	No OEM Part # Available				
VPV005	Solenoid Valve Assembly			64568156		
VPV015	Solenoid Valve Assembly		PW10470		77005146 & 77001620	77005146 & 77001620
VPV017	Solenoid Valve Assembly	55387				
VPV036	Solenoid Valve Assembly	55040, 55060, 55080, 55107 & 55116				
VPV038	Solenoid Valve Assembly		PW10472			77001621

Call Us Toll-Free Monday–Friday, 8:00 AM–4:30 PM (Pacific Time), (800) 221-9723

Dental Equipment

Air Techniques, Apollo/Midmark®, DentalEZ®/Custom Air/RamVac, Matrix/Midmark®, Midmark® & Tech West

With RPI, now you have a choice to replace the Solenoid Valve or repair it with one of our exclusive Kits – It's the RPI Advantage!

RPI Part #VPV019

OEM Part # See Chart Below



SOLENOID VALVE ASSEMBLY

- Ports: 1/8" FPT; 2-way; N.C.
 - 120VAC, 60Hz., 6.3W; 18" lg. wires
 - Material: Stainless steel body; Viton seals
 - Includes all parts as shown
- Fits:** Water Control Assembly

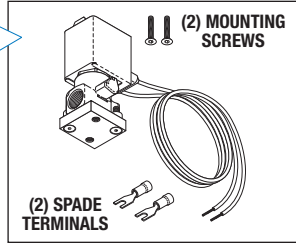

RPI Part #VPK020

OEM Part # See Chart Below



SOLENOID VALVE REPAIR KIT

- Includes all parts as shown
 - Also available: Solenoid Valve Assembly (RPI Part #'s VPV019 & VPV037)
- Fits:** Solenoid Valve Assembly

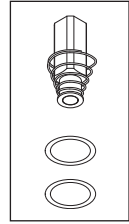

RPI Part #VPV037

OEM Part # See Chart Below



SOLENOID VALVE ASSEMBLY

- Ports: 1/8" FPT; 2-way; N.C.
 - 220VAC, 60HZ., 6.3W; 18" lg. wires
 - Material: Stainless steel body; Viton seals
 - Includes all parts as shown
- Fits:** Water Control Assembly

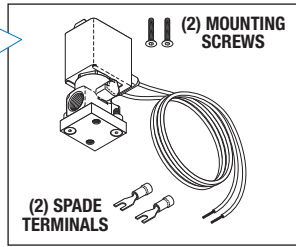

RPI Part #VPK020

OEM Part # See Chart Below



SOLENOID VALVE REPAIR KIT

- Includes all parts as shown
 - Also available: Solenoid Valve Assembly (RPI Part #'s VPV019 & VPV037)
- Fits:** Solenoid Valve Assembly

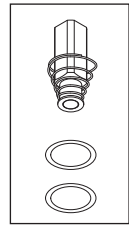

RPI Part #VPV034

OEM Part # See Chart Below



SOLENOID VALVE ASSEMBLY

- Ports: 1/8" FPT; 2-way; N.C.
 - 120VAC; 60Hz., 8W; 24" lg. wires
 - Material: Stainless steel body; Nitrile (Buna-N) seals
 - Includes all parts as shown
- Fits:** Water Control Assembly

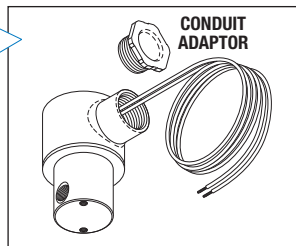

RPI Part #VPK035

OEM Part # See Chart Below



SOLENOID VALVE REPAIR KIT

- Includes all parts as shown
 - Also available: Solenoid Valve Assembly (RPI Part #VPV034)
- Fits:** Solenoid Valve Assembly

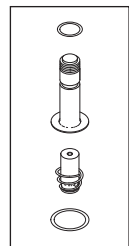

RPI PART #	DESCRIPTION	AIR TECHNIQUES	APOLLO/MIDMARK®	DENTALEZ®/CUSTOM AIR/RAMVAC	MATRIX/MIDMARK®	MIDMARK®	TECH WEST
VPK020	Solenoid Valve Repair Kit	No OEM Part # Available					
VPK035	Solenoid Valve Repair Kit						No OEM Part # Available
VPV019	Solenoid Valve Assembly	55519					
VPV034	Solenoid Valve Assembly						PSV-115
VPV037	Solenoid Valve Assembly	55518					

With RPI, now you have a choice to replace the Anti-Syphon Valve or repair it with one of our Kits – It's the RPI Advantage!

APOLLO BRAND

RPI Part #VPV021

OEM Part # See Chart Below



ANTI-SYPHON VALVE (1/4")

- Material: Brass; Silicone seal
 - Ports: 1/4" FPT
- Fits:** Water Control Assembly

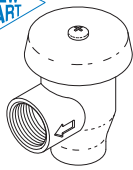

APOLLO BRAND

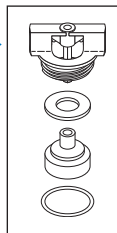

RPI Part #VPK008

OEM Part # See Chart Below

ANTI-SYPHON VALVE REPAIR KIT

- Includes all parts as shown
 - Material: Silicone seal
 - Used to repair the **Apollo** brand Anti-Syphon Valve (1/4" & 3/8") **Only**
 - For Watts brand Anti-Syphon Valve Repair Kit, use RPI Part #VPK016
- Fits:** Apollo Anti-Syphon Valves (RPI Part #'s VPV007 and VPV021)

WATTS BRAND

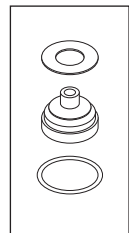

RPI Part #VPK016

OEM Part # See Chart Below

ANTI-SYPHON VALVE REPAIR KIT

- Includes all parts as shown
 - Material: Silicone seal
 - Used to repair the **Watts** brand Anti-Syphon Valve (1/4" & 3/8") **Only**
 - For Apollo brand Anti-Syphon Valve Repair Kit, use RPI Part #VPK008
- Fits:** Watts 1/4" and 3/8" Anti-Syphon Valves

APOLLO BRAND

RPI Part #VPV007

OEM Part # See Chart Below



ANTI-SYPHON VALVE (3/8")

- Material: Brass; Silicone seal
 - Ports: 3/8" FPT
 - Included in: Water Control Assembly (RPI Part #'s VPA001 & VPA002)
- Fits:** Water Control Assembly

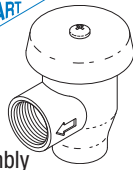

RPI PART #	DESCRIPTION	AIR TECHNIQUES	APOLLO/MIDMARK®	DENTALEZ®/CUSTOM AIR/RAMVAC	MATRIX/MIDMARK®	MIDMARK®	TECH WEST
VPK008	Anti-Syphon Valve Repair Kit	55517	No OEM Part # Available	64568016A	77005073	77005073	No OEM Part # Available
VPK016	Anti-Syphon Valve Repair Kit	55517	No OEM Part # Available	64568016A	77005073	77005073	No OEM Part # Available
VPV007	Anti-Syphon Valve (3/8")	55525		64622011			
VPV021	Anti-Syphon Valve (1/4")		PW50595		77005072	77005072	PVB100

FAX: (818) 882-7028 • E-MAIL: order@rpiarts.com • WEBSITE: www.rpiarts.com

Air Techniques, Apollo/Midmark®, DentalEZ®/Custom Air/RamVac, Matrix/Midmark®, Midmark® & Tech West

DENTAL VACUUM UNITS -

SECTION 4

PAGE 1707

UPDATED 09/15

RPI Part #VPR009
OEM Part # See Chart Below

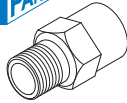

FLOW REGULATOR (0.5 GPM)

- Material: Nickel plated brass
- Ports: 3/8" FPT x 3/8" MPT
- Included in: Water Control Assembly (1 HP) (RPI Part #VPA001)

Fits: Water Control Assembly

RPI Part #VPR010
OEM Part # See Chart Below

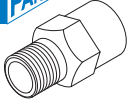

FLOW REGULATOR (1 GPM)

- Material: Nickel plated brass
- Ports: 3/8" FPT x 3/8" MPT
- Included in: Water Control Assembly (2 HP) (RPI Part #VPA002)

Fits: Water Control Assembly

RPI Part #VPR022
OEM Part # See Chart Below

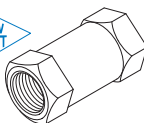

FLOW REGULATOR (0.13 GPM)

- Material: Nickel plated brass
- Ports: 3/8" FPT

Fits: Water Control Assembly

RPI Part #VPR023
OEM Part # See Chart Below

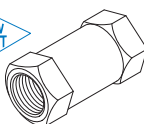

FLOW REGULATOR (0.19 GPM)

- Material: Nickel plated brass
- Ports: 3/8" FPT

Fits: Water Control Assembly

RPI Part #VPR024
OEM Part # See Chart Below

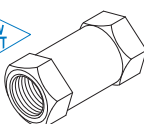

FLOW REGULATOR (0.25 GPM)

- Material: Nickel plated brass
- Ports: 3/8" FPT

Fits: Water Control Assembly

RPI Part #VPR025
OEM Part # See Chart Below

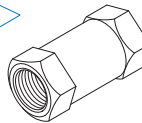

FLOW REGULATOR (1 GPM)

- Material: Nickel plated brass
- Ports: 3/8" FPT

Fits: Water Control Assembly

RPI Part #VPR026
OEM Part # See Chart Below

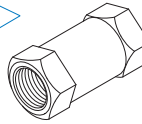

FLOW REGULATOR (.50 GPM)

- Material: Nickel plated brass
- Ports: 3/8" FPT

Fits: Water Control Assembly

RPI Part #VPR027
OEM Part # See Chart Below

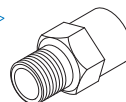

FLOW REGULATOR (0.75 GPM)

- Material: Nickel plated brass
- Ports: 3/8" FPT x 3/8" MPT

Fits: Water Control Assembly

RPI Part #VPR028
OEM Part # See Chart Below

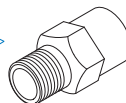

FLOW REGULATOR (1.5 GPM)

- Material: Nickel plated brass
- Ports: 3/8" FPT x 3/8" MPT

Fits: Water Control Assembly

RPI Part #VPR030
OEM Part # See Chart Below



FLOW REGULATOR (.19 GPM)

- Material: Brass
- Size: 1/4" Polyflo x 1/4" MPT

Fits: Water Control Assembly

RPI Part #VPR031
OEM Part # See Chart Below



FLOW REGULATOR (.19 GPM)

- Material: Brass
- Size: 1/4" Push-in fitting x 1/4" MPT
- See our website www.rpiparts.com for the quantity required for specific models

Fits: Vacuum System

RPI Part #VPR032
OEM Part # See Chart Below

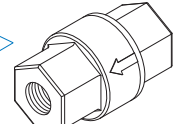

FLOW REGULATOR (.26 GPM)

- Material: Black plastic
- Ports: 1/4" FPT
- For use with vacuum pumps equipped with water recyclers only
- See our website www.rpiparts.com for the quantity required for specific models

Fits: Water Injection Assembly

RPI Part #VPR033
OEM Part # See Chart Below

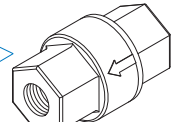

FLOW REGULATOR (.73 GPM)

- Material: Black plastic
- Ports: 1/4" FPT
- For use with vacuum pumps not equipped with water recyclers
- See our website www.rpiparts.com for the quantity required for specific models

Fits: Water Injection Assembly

RPI Part #VPV029
OEM Part # See Chart Below



VALVE (SHUT OFF)

- Material: Brass; PTFE seat
- Ports: 1/4" FPT
- -40°F to 300°F
- 1000 PSI Max

Fits: Water Control Assembly

RPI PART #	DESCRIPTION	AIR TECHNIQUES	APOLLO/MIDMARK®	DENTALEZ®/CUSTOM AIR/RAMVAC	MATRIX/MIDMARK®	MIDMARK®	TECH WEST
VPR009	Flow Regulator (0.5 GPM)	55523		64568192			
VPR010	Flow Regulator (1 GPM)			64622010			
VPR022	Flow Regulator (0.13 GPM)			6-4622-018			
VPR023	Flow Regulator (0.19 GPM)		PW50505				
VPR024	Flow Regulator (0.25 GPM)			6-4622-019			
VPR025	Flow Regulator (1 GPM)	56010					
VPR026	Flow Regulator (0.50 GPM)		PW50507				
VPR027	Flow Regulator (0.75 GPM)	55524					
VPR028	Flow Regulator (1.5 GPM)	56011					
VPR030	Flow Regulator (.19 GPM)				10362300		
VPR031	Flow Regulator (.19 GPM)					20202900	
VPR032	Flow Regulator (.26 GPM)						WIN-RP
VPR033	Flow Regulator (.73 GPM)						WIN-2P
VPV029	Valve (Shut Off)				61301100	61301100	

Call Us Toll-Free Monday–Friday, 8:00 AM–4:30 PM (Pacific Time), (800) 221-9723

Dental Equipment

Air Techniques, Apollo/Midmark®, DentalEZ®/Custom Air/RamVac, Matrix/Midmark®, Midmark® & Tech West

RPI Part #RPT905
OEM Part # (No OEM Part # Available)



FLAG TERMINAL (1/4" QC)

- 20 per package
- Mating Tab Size: .250" x .032"
- Wire Range: #22-18 AWG
- Style: Right Angle, Female Non-Insulated
- Also available: Terminal Crimp Tool (RPI Part #RPT482)

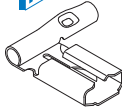

RPI Part #RPF228
OEM Part # (No OEM Part # Available)

MALE CONNECTOR

- 5 per package
 - Material: Brass
 - Size: 3/16" Tubing x 1/4" MPT;
 - Hex Size: 1/2"
 - Fits: 1/4" O.D. tube
- Fits:** Water Control Assembly

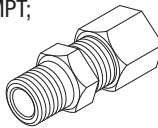

RPI Part #RPF231
OEM Part # (No OEM Part # Available)

MALE ELBOW

- 5 per package
 - Material: Brass
 - Size: 1/4" tubing x 1/8" MPT
- Fits:** Water Control Assembly

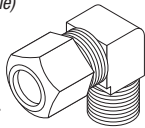

RPI Part #RPF883
OEM Part # (No OEM Part # Available)



POLYFLO NUT (1/4")

- 5 per package
 - Material: Brass
 - Fits: 1/4" O.D. plastic tube
- Fits:** Water Control Assembly

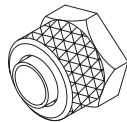

RPI Part #RPF884
OEM Part # (No OEM Part # Available)



ADAPTOR (1/8" MPT x 1/8" MPT)

- 5 per package
 - Material: Brass
 - Size: 1/8" MPT x 1/8" MPT
- Fits:** Water Control Assembly

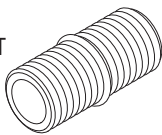

RPI Part #RPF885
OEM Part # (No OEM Part # Available)



ELBOW (1/4" POLY x 1/8" MPT)

- 2 per package
 - Material: Brass
- Fits:** Water Control Assembly

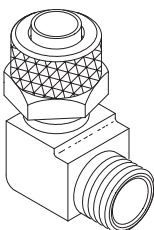

RPI Part #RPF886
OEM Part # (No OEM Part # Available)



ADAPTOR (1/8" MPT x 1/4" MPT)

- 2 per package
 - Material: Brass
- Fits:** Water Control Assembly

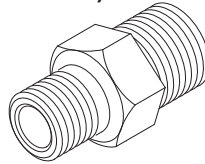

RPI Part #RPF887
OEM Part # (No OEM Part # Available)



ADAPTOR (1/4" FPT x 1/4" FPT)

- 2 per package
 - Material: Brass
- Fits:** Water Control Assembly

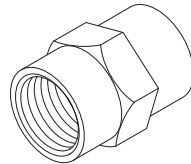

RPI Part #RPF888
OEM Part # (No OEM Part # Available)



ADAPTOR (1/8" MPT x 1/4" FPT)

- 2 per package
 - Material: Brass
- Fits:** Water Control Assembly

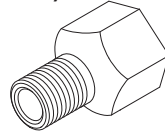

RPI Part #RPF889
OEM Part # (No OEM Part # Available)



ELBOW (1/8" FPT x 1/8" MPT)

- 2 per package
 - Material: Brass
- Fits:** Water Control Assembly

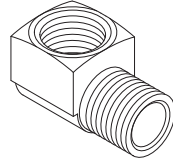

RPI Part #RPF890
OEM Part # (No OEM Part # Available)



ELBOW (1/4" FPT x 1/4" MPT)

- 2 per package
 - Material: Brass
- Fits:** Water Control Assembly

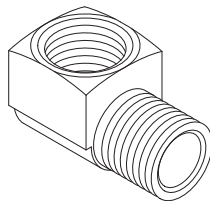

RPI Part #RPF891
OEM Part # (No OEM Part # Available)



ADAPTOR (1/8" FPT x 1/8" MPT)

- 2 per package
 - Material: Brass
- Fits:** Water Control Assembly

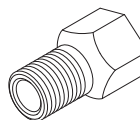

RPI Part #RPF892
OEM Part # (No OEM Part # Available)



ADAPTOR (1/8" FPT x 3/8" MPT)

- 2 per package
 - Material: Brass
- Fits:** Water Control Assembly

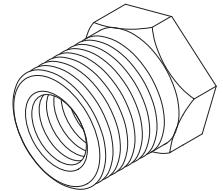

RPI Part #RPF893
OEM Part # (No OEM Part # Available)



ELBOW (1/4" POLY x 3/8" MPT)

- 2 per package
 - Material: Brass
- Fits:** Water Control Assembly

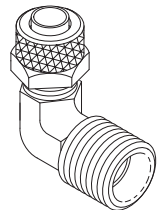

RPI Part #RPA459
OEM Part # (No OEM Part # Available)

PIPE SEALANT 567

- .20 fl. oz. (6ml) per unit
- Temperature range: -65°F to 400°F (-54° to 204°C)

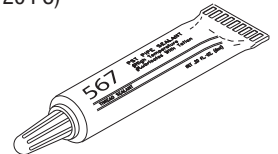

RPI Part #RPT579
OEM Part # (No OEM Part # Available)

1/4" TEFLON THREAD SEALING TAPE

- 5 per package
- 1/4" x 260" per unit

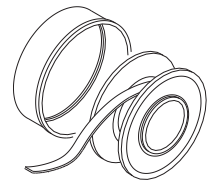

RPI Part #RPT580
OEM Part # (No OEM Part # Available)

1/2" TEFLON THREAD SEALING TAPE

- 5 per package
- 1/2" x 260" per unit

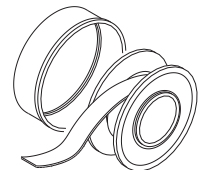

Air Techniques, Apollo/Midmark®, DentalEZ®/Custom Air/RamVac, Matrix/Midmark®, Midmark® & Tech West

DENTAL VACUUM UNITS -

SECTION
4
 PAGE
1709
 UPDATED
 09/15

RPI Part #VPV119
OEM Part # See Chart Below



CHECK VALVE (1")

- Cracking Pressure: 0.5 PSI
- Ports: 1" FPT
- Material: Bronze body; RPTFE seal
- Size: 1.93" dia. x 3.50" lg.

Fits: Motor Assembly

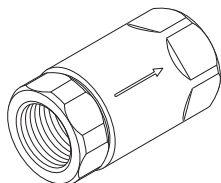

RPI Part #VPV120
OEM Part # See Chart Below



CHECK VALVE (1-1/2")

- Ports: 1-1/2" FPT
- Material: Clear PVC
- Size: 3.38" dia. x 5.75" lg.

Fits: Drain Assembly

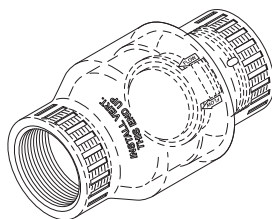

RPI Part #VPV122
OEM Part # See Chart Below



CHECK VALVE (1-1/2")

- Ports: 1-1/2" pipe compression fitting
- Material: PVC; Nitrile (Buna N) seal
- Size: 2.94" dia. x 5.25" lg.
- Included in: Drain Assembly (RPI Part #VPA121)

Fits: Drain Assembly

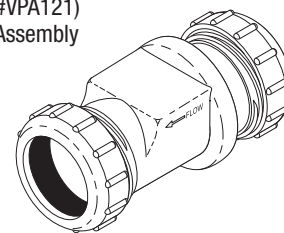

RPI Part #VPC136
OEM Part # See Chart Below



SOLIDS COLLECTOR (1-1/2")

- Ports: 1-1/2" FPT
- Material: Black plastic body with clear plastic bowl
- Includes: Bowl, Bowl Gasket (RPI Part #VPG081) and Screen (20 Mesh) (RPI Part #VPS140)
- Also available: Screen (50 Mesh) (RPI Part #VPS139)

Fits: Separator Assembly

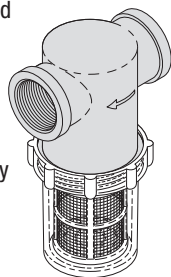

RPI Part #VPK137
OEM Part # See Chart Below



SOLIDS COLLECTOR REPLACEMENT KIT

- Includes all parts as shown

Fits: Solids Collector (1-1/2")

ALSO AVAILABLE BY THE CASE!

RPI Part #VPK138
OEM Part # See Chart Below

SOLIDS COLLECTOR REPLACEMENT KIT (CASE of 8)

- Includes: (8) Solids Collector Replacement Kits (RPI Part #VPK137)

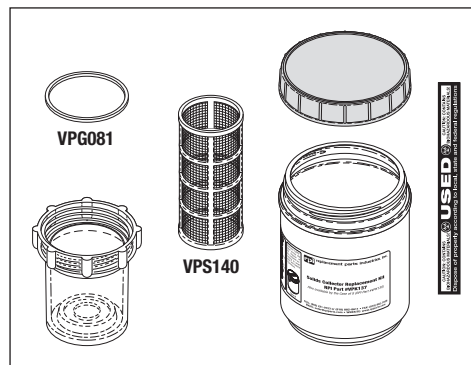

RPI Part #VPG081
OEM Part # See Chart Below

BOWL GASKET

- 3 per package
- Material: Buna N (Nitrile)
- Size: 3.13" OD x .13" Square

Fits: Solids Collector Assembly (1", 1-1/4" & 1-1/2")

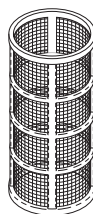

RPI Part #VPS140
OEM Part # See Chart Below

SCREEN (20 MESH)

- Material: Stainless steel screen, Red plastic cage
- Size: 2.47" OD x 5.46" lg.

Fits: Solids Collector (1-1/2")



RPI Part #VPS139
OEM Part # See Chart Below

SCREEN (50 MESH)

- Material: Stainless steel screen, Blue plastic cage
- Size: 2.47" OD x 5.46" lg.

Fits: Solids Collector (1-1/2")

RPI PART #	DESCRIPTION	AIR TECHNIQUES	APOLLO/MIDMARK®	DENTALEZ®/CUSTOM AIR/RAMVAC	MATRIX/MIDMARK®	MIDMARK®
VPC136	Solids Collector (1-1/2")	H5181 & H5216	PVC50700 & AVAVPF2		62937303	62937303
VPG081	Bowl Gasket - 3/PKG	No OEM Part # Available	MRP70936	No OEM Part # Available	77005158	77005158
VPK137	Solids Collector Replacement Kit	H5217	AVA60031		77005169	77005169
VPK138	Solids Collector Replacement Kit (Case of 8)	No OEM Part # Available	AVA60030		77005179	77005179
VPS139	Screen (50 Mesh)	No OEM Part # Available	No OEM Part # Available		No OEM Part # Available	No OEM Part # Available
VPS140	Screen (20 Mesh)	No OEM Part # Available	No OEM Part # Available		77005079	No OEM Part # Available
VPV119	Check Valve (1")					014-0552-01
VPV120	Check Valve (1-1/2")	54075				014-0551-00
VPV122	Check Valve (1-1/2")	54139				











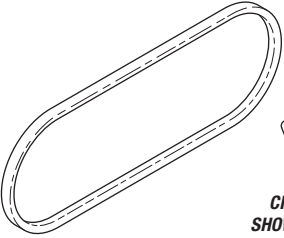

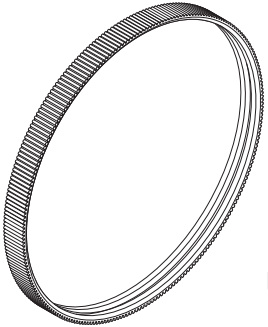
Call Us Toll-Free Monday–Friday, 8:00 AM–4:30 PM (Pacific Time), (800) 221-9723

Dental Equipment

Air Techniques, Apollo/Midmark®, DentalEZ®/Custom Air/RamVac, MatrX/Midmark®, & Midmark®

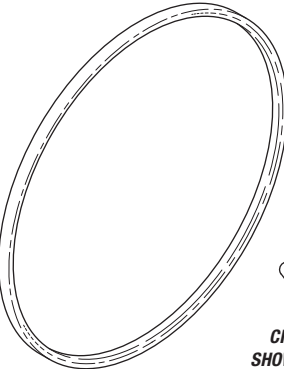
Air Techniques, Apollo/Midmark®,
DentalEZ®/Custom Air/RamVac,
MatrX/Midmark®, & Midmark®

DENTAL VACUUM UNITS -

IMAGE	RPI PART #	DESCRIPTION	DENTALEZ®/ CUSTOM AIR/ RAMVAC	MIDMARK®
 <p>CROSS SECTION SHOWN ACTUAL SIZE</p>	 VPB096	Drive Belt • Industry Part #4L370-A35F • V-Belt; Effective Belt Length: 37.0" • Size: .50" @ top x .31" thk.		016-1055-00 & 202110
	 VPB097	Drive Belt • Industry Part #4L380-A36F • V-Belt; Effective Belt Length: 38.0" • Size: .50" @ top x .31" thk.		016-1056-00
 <p>CROSS SECTION SHOWN ACTUAL SIZE</p>	 VPB098	Drive Belt • Industry Part #2/7M650JB • Effective Belt Length: 25.59" • Size: .63" @ top x .31" thk.	000273SP	
	 VPB099	Drive Belt • Industry Part #2/7MB670JB • Effective Belt Length: 26.38" • Size: .63" @ top x .31" thk.	000274SP	
	 VPB100	Drive Belt • Industry Part #2/7M580JB • Effective Belt Length: 22.83" • Size: .63" @ top x .31" thk.	002035SP	
	 VPB101	Drive Belt • Industry Part #2/7M600JB • Effective Belt Length: 23.62" • Size: .63" @ top x .31" thk.	002027SP	
	 VPB102	Drive Belt • Industry Part #2/7M545JB • Effective Belt Length: 21.46" • Size: .63" @ top x .31" thk.	002034SP	
 <p>CROSS SECTION SHOWN ACTUAL SIZE</p>	 VPB103	Drive Belt • Industry Part #A41 • V-Belt; Effective Belt Length: 43.0" • Size: .50" @ top x .31" thk. • All units require 2 Belts	0002163SP	
	 VPB104	Drive Belt • Industry Part #A42 • V-Belt; Effective Belt Length: 44.0" • Size: .50" @ top x .31" thk. • All units require 2 Belts	0002164SP	
	 VPB105	Drive Belt • Industry Part #A40 • V-Belt; Effective Belt Length: 42.0" • Size: .50" @ top x .31" thk. • All units require 2 Belts	0002360SP	



RPI Part #RPT954
OEM Part # (No OEM Part # Available)

BELT TENSIONER TESTER

- Range: 0-35 lbs. (0-15.9 kg) with a span of up to 170" lg. or belt deflection of up to 2.75"
- Includes: Pocket clip and clear storage tube
- Also available: O-Ring (RPI Part #RPO302) and O-Ring (RPI Part #RPO315)

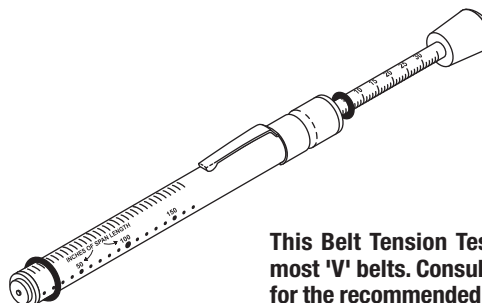

This Belt Tension Tester measures the belt tension of most 'V' belts. Consult the OEM or the belt manufacturer for the recommended belt tension for each drive system.



RPI Part #VPK128
OEM Part # See Chart Below

BRUSH KIT

- Includes all parts as shown
- Size: .25" x .25" x .69" lg.
- Radius: .38"; Spring Length: 1-1/16"
- OEM recommends replacement every 300 hours of use
- Also available: Pump Repair Kit (RPI Part #VPK127)

Fits: Liquid Evacuation Pump

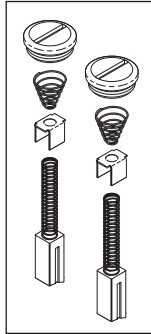

RPI Part #VPK127
OEM Part # See Chart Below

PUMP REPAIR KIT

- Includes: (1) Impeller and (1) gasket
- Also available: Brush Kit (RPI Part #VPK128)

Fits: Liquid Evacuation Pump

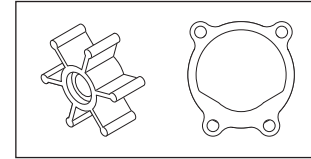

RPI Part #VPK123
OEM Part # See Chart Below

TANK WASHOUT KIT

- Includes: Adaptor (3/8" Push-In x 1/2" MPT) and (10 ft.) Tubing (1/4" ID x 3/8" OD Clear) (RPI Part #RPT959)
- Material: Clear polyethylene

Fits: CAS Tank (Cyclonic Action Separator)

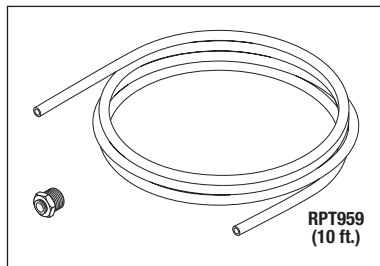

RPT959
(10 ft.)



RPI Part #RPT959
OEM Part # See Chart Below

TUBING (1/4" ID x 3/8" OD CLEAR)

- Sold by the foot (reel not included)
- Material: Clear polyethylene

Fits: 3/8" Polyflo Fitting or 1/4" Barb Fitting

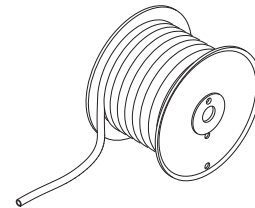

RPI Part #VPL131
OEM Part # See Chart Below

SYNTHETIC OIL (MOBIL 1®)

- Size: 1 Quart (.946 Liter) bottle
- 15W-50 (ISO grade 32)

Fits: Vacuum Unit



ALSO AVAILABLE BY THE CASE!

RPI Part #VPL132
OEM Part # See Chart Below

SYNTHETIC OIL (MOBIL 1®)
(CASE of 6)

- Case includes: (6) 1 Quart (.946 Liter) bottles

RPI Part #VPL133
OEM Part # See Chart Below

OIL-SYN GEARBOX (1 Qt.)

- Size: 1 Quart (.946 Liter) bottle
- Mobil SHC 630 (ISO grade 220)

Fits: Vacuum Unit



ALSO AVAILABLE BY THE CASE!

RPI Part #VPL134
OEM Part # See Chart Below

OIL-SYN GEARBOX
(CASE of 12)

- Case includes: (12) 1 Quart (.946 Liter) bottles

RPI PART #	DESCRIPTION	AIR TECHNIQUES	DENTAL EZ®/CUSTOM AIR/RAMVAC	MATR X/MIDMARK®	MIDMARK®
RPT959	Tubing (1/4" ID x 3/8" OD Clear Poly)	54601		77002004	77002004
VPK123	Tank Washout Kit			77008009 & 77002004	77008009 & 77002004
VPK127	Pump Repair Kit			77001507	77001507
VPK128	Brush Kit			77001506	77001506
VPL131	Synthetic oil (Mobil 1®)		No OEM Part # Available		
VPL132	Synthetic oil (Mobil 1®) (Case of 6)		380706		
VPL133	Oil-Syn Gearbox (1 Qt.)				064-0028-01
VPL134	Oil-Syn Gearbox (Case of 12)				No OEM Part # Available

Call Us Toll-Free Monday-Friday, 8:00 AM-4:30 PM (Pacific Time), (800) 221-9723

Dental Equipment

Air Techniques, Apollo/Midmark®, DentalEZ®/Custom Air/RamVac, Matrx/Midmark®, & Midmark®

Service Tip: Air filter life depends on vacuum usage, nature of environment, and amount of aspirated material. Inspect air filter every 1,000 hours and replace every 2,000 hours or when visibly dirty. Also, inspect the oil filter every 1,000 hours and change the oil filter element every 2,000 hours or when changing the oil.

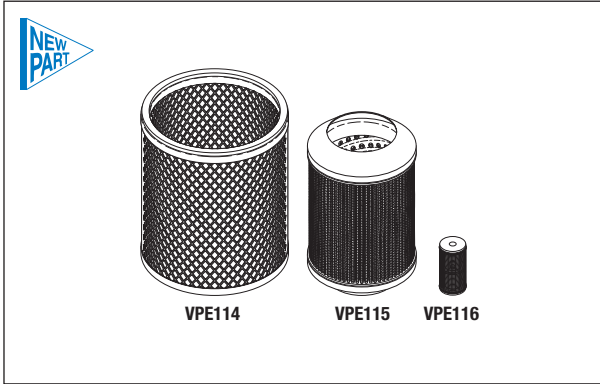

RPI Part #VPK113
OEM Part #003740

FILTER KIT

- See **Service Tip** below
 - Includes all parts as shown
- Fits:** Vacuum Controller Assembly

Models: DentalEZ/Custom Air/RamVac:
Bulldog 550, Bulldog QT1, Bulldog QT2, Bulldog QT3

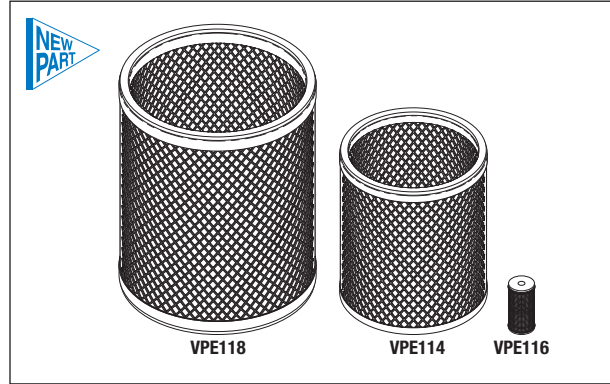

RPI Part #VPK117
OEM Part #003750

FILTER KIT

- See **Service Tip** below
 - Includes all parts as shown
- Fits:** Vacuum Controller Assembly

Models: DentalEZ/Custom Air/RamVac:
Bison 3, Bison 5, Bison 7, Bison 9



RPI Part #VPE116
OEM Part #310705

OIL FILTER ELEMENT

- Size: .78" OD x 1.62" lg.
- Material: 200 Mesh stainless steel and 2 Nitrile (Buna N) O-rings
- See **Service Tip** below
- Includes: PM Sticker

Fits: Vacuum Controller Assembly
Models: DentalEZ/Custom Air/RamVac:
Bison 3, Bison 5, Bison 7, Bison 9, Bulldog 550, Bulldog QT1, Bulldog QT2, Bulldog QT3

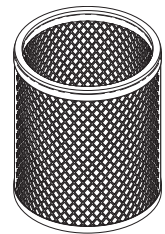

RPI Part #VPE114
OEM Part #003550SP

FILTER ELEMENT

- 5 Micron
- Size: 4.56" OD x 5.36" lg.
- See **Service Tip** below
- Includes: PM Sticker

Fits: Vacuum Controller Assembly
Models: DentalEZ/Custom Air/RamVac:
Bison 3, Bison 5, Bison 7, Bison 9, Bulldog 550, Bulldog QT1, Bulldog QT2, Bulldog QT3

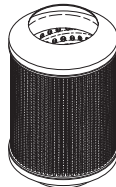

RPI Part #VPE115
OEM Part #003548SP

FILTER ELEMENT

- 3 Micron
- Size: 3.40" OD x 5.15" lg.
- See **Service Tip** below
- Includes: PM Sticker

Fits: Vacuum Controller Assembly
Models: DentalEZ/Custom Air/RamVac:
Bulldog 550, Bulldog QT1, Bulldog QT2, Bulldog QT3

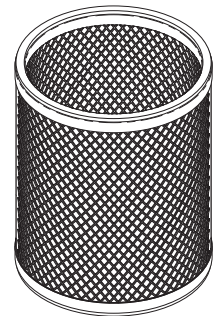

RPI Part #VPE118
OEM Part #003549SP

FILTER ELEMENT

- 5 Micron
- Size: 6.00" OD x 7.45" lg.
- See **Service Tip** below
- Includes: PM Sticker

Fits: Vacuum Controller Assembly
Models: DentalEZ/Custom Air/RamVac:
Bison 3, Bison 5, Bison 7, Bison 9



RPI Part #VPA125
OEM Part #002-1448-00

FLOAT ASSEMBLY (NEW)

- 2 Float Switches
- **Service Tip:** Earlier versions of the PowerVac had three float switches, later PowerVac models and all PowerVac G models used two float switches. The middle float switch was for the liquid Evacuation Pump Option. If you have a liquid Evacuation pump connected to an earlier Power Vac you must replace the float assembly with a three Float Switch Assembly (RPI Part #VPA126). If there is no Evacuation pump connected to the PowerVac, you can replace the float with this version of the two float switch assembly.
- Includes: Two float switches with harness, float assembly bracket, PVC tank adaptor, cable gland and plug assembly with cable clamp.

Fits: Separator Tank

Models: **Midmark®:** PowerVac G G3, PowerVac G G5, PowerVac G G6, PowerVac G G7, PowerVac G G10 & PowerVac G G14 (all Serial Numbers); PowerVac P3, PowerVac P5, PowerVac P6, PowerVac P7, PowerVac P10 & PowerVac P14 (Serial # V975825 to Present)

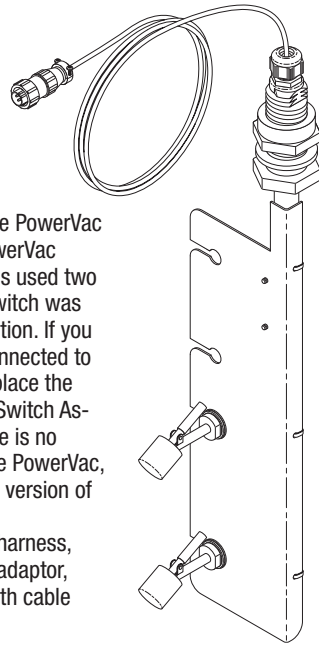

RPI Part #VPA126
OEM Part #015-2067-00

FLOAT ASSEMBLY (OLD)

- 3 Float Switches
- **Service Tip:** Earlier versions of the PowerVac had three float switches, later PowerVac models and all PowerVac G models used two float switches. The middle float was for the liquid Evacuation Pump Option. If you have a liquid Evacuation pump connected to an earlier Power Vac you can replace the float assembly with this three float switch assembly. If there is no Evacuation pump connected to the PowerVac, you can replace the float assembly with the two Float Switch Assembly (RPI Part #VPA125).
- Includes: Three float switches with harness, float assembly bracket, PVC tank adaptor, cable gland and plug assembly with cable clamp

Fits: Separator Tank

Models: **Midmark®:** PowerVac P3, PowerVac P5 & PowerVac P7 (Serial #V245092 to V975824 & 0611P3P0000 thru Present)

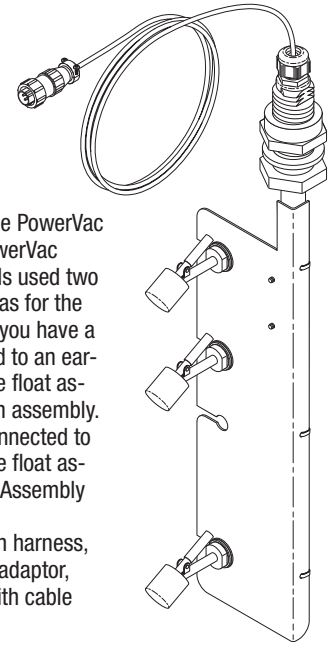

RPI Part #VPG106
OEM Part #053-1616-00

GASKET (SEPARATOR LID)

- Size: 12.62" OD X .46" thk.
- Material: Nitrile (Buna N); 70 Duro

Fits: Separator Lid and Tank

Models: **Midmark®:** PowerVac P3, PowerVac P5 & PowerVac P7 (Serial #V245092 to V975824 & 0611P3P0000 thru Present)

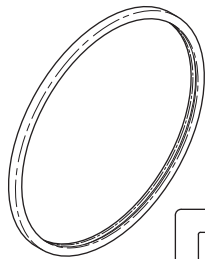

VPG106
CROSS SECTION
SHOWN ACTUAL SIZE



RPI Part #VPG108
OEM Part #65950000

FLANGE GASKET

- Size: 6.05" OD x .13" thk.
- Material: Nitrile (Buna N); 70 Duro

Fits: Separator Tank

Models: **Matrx/Midmark®:** DryMax 4000/8000

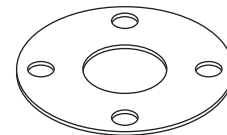

RPI Part #VPG107
OEM Part #053-2159-00

GASKET (SEPARATOR LID)

- Size: 21.50" OD x .34" thk.
- Material: Nitrile (Buna N); 70 Duro
- See **Note 1** below for quantity required for each model

Fits: Separator Lid and Tank

Models: **Midmark®:** PowerVac G G3, PowerVac G G5, PowerVac G G6, PowerVac G G7, PowerVac G G10 & PowerVac G G14, PowerVac P6, PowerVac P10 & PowerVac P14 (all Serial Numbers); PowerVac P3, PowerVac P5 & PowerVac P7 (Serial # V975825 to Present)

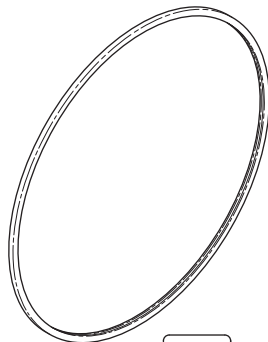

VPG107
CROSS SECTION
SHOWN ACTUAL SIZE



RPI Part #VPG109
OEM Part #54619

CAS COVER GASKET

- Size: 15.27" OD x .21" thk.
- Material: Nitrile (Buna N); 50 Duro with adhesive backing

Fits: CAS Cover (Cyclonic Action Separator)

Models: **Air techniques:** CAS 4-Gallon, CAS 4-Gallon with Guardian, CAS 8-Gallon (New Style), CAS 8-Gallon (Old Style), CAS 8-Gallon with Guardian & CAS 20-Gallon

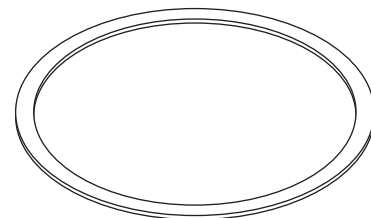

VPG109
CROSS SECTION
SHOWN ACTUAL SIZE

Note 1: **Midmark:** PowerVac P3, P5, P7, PowerVac G G3, G5, G7 have one separator tank; and PowerVac P6, P10, P14, PowerVac G G6, G10 & G14 have two separator tanks..

Dental Equipment

Air Techniques, Apollo/Midmark®, DentalEZ®/Custom Air/RamVac, Matrx/Midmark®, & Midmark®

RPI Part #VPV124
OEM Part #029-3811-00



VACUUM RELIEF VALVE

- Material: Dark grey plastic
- Preset @ approx. 5 lb. (adjustable)
- Includes: Vacuum Relief Valve (1" (RPI Part #VPV060) and Foam Element (RPI Part #CMF013)
- See **Note 1** below for quantity required for each model

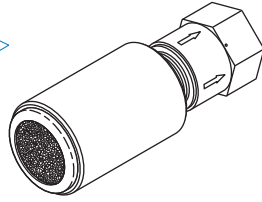

Fits: Separator Assembly

Models: **Midmark®:** PowerVac P3, PowerVac P5, PowerVac P6, PowerVac P7, PowerVac P10 & PowerVac P14

Note 1: **Midmark:** PowerVac P3, P5 & P7 require 1 each; and PowerVac P6, P10 & P14 require 2 each.

RPI Part #VPA121
OEM Part #54660



DRAIN ASSEMBLY

- Includes: Check Valve (1-1/2" (RPI Part #VPV122)

Fits: Separator Tank

Models: **Air techniques:** CAS 4-Gallon, CAS 8-Gallon (New Style), CAS 8-Gallon (Old Style) & CAS 20-Gallon

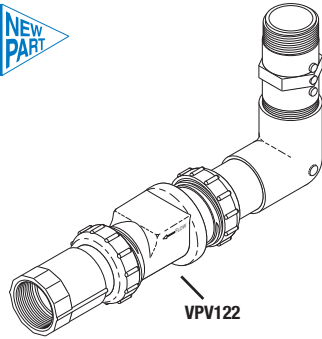

RPI Part #VPS129
OEM Part #62950600



FLOAT SWITCH (FAIL-SAFE)

- SPST; 24" lg.
- 1/2" MPT mounting thread
- Material: Polypropylene

Fits: Separator Tank

Models: **Matrx/Midmark®:** DryMax 4000/8000

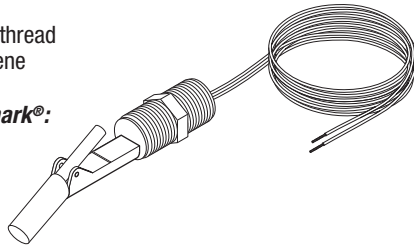

RPI Part #VPV141
OEM Part #77002144

VACUUM RELIEF VALVE (PLATFORM)

- Port: 3/4" MPT
- Material: PVC
- Includes: Vacuum Gauge (Liquid Filled) (RPI Part #VPG044) and Foam Element (RPI Part #CMF013)

Fits: Twin Intake Manifold Assembly or Platform Mount

Models: **Matrx/Midmark®:** Maximizer 1000-2P, Maximizer 2000-2P, Minimizer 1000-2P & Minimizer 2000-2P;

Midmark®: CV6, CV6R, CV10 & CV10R

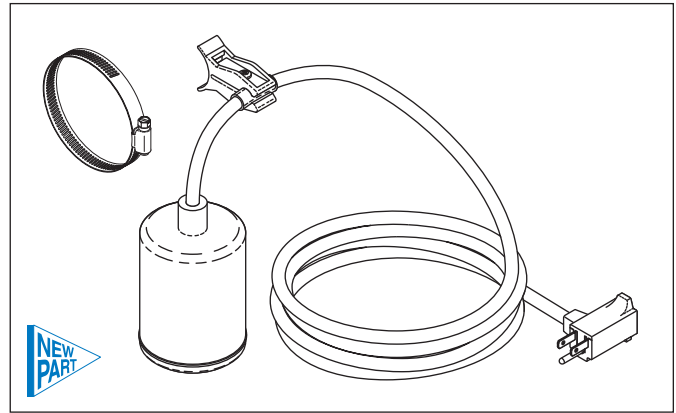
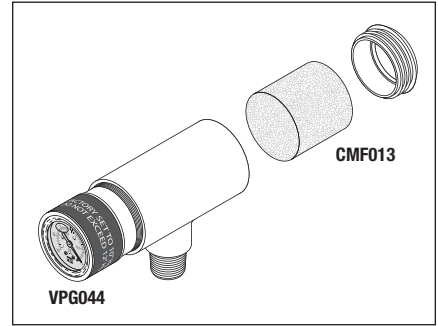

RPI Part #VPS130
OEM Part #62950500

FLOAT SWITCH (DIFFERENTIAL)

- 115VAC, N.O.
- Size: 3" dia. x 3" lg. float, with 10' lg. cable
- Includes: Hose clamp and pipe/cable clamp

Fits: Separator Tank

Models: **Matrx/Midmark®:** DryMax 4000/8000

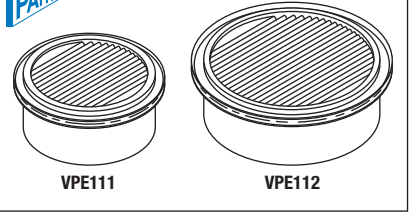

RPI Part #VPK110
OEM Part #005301SP

FILTER KIT

- Includes: Filter Element (RPI Part #VPE111), Filter Element (RPI Part #VPE112) and PM Stickers

Fits: Vacuum Controller Assembly

Model:

DentalEZ/Custom Air/RamVac: Badger



RPI Part #VPE111
OEM Part #004691SP

FILTER ELEMENT

- 5 Micron polyester filter
- Size: 3.00" OD x 1.00" lg.
- Includes: PM Sticker
- Included in: Filter Kit (RPI Part #VPK110)

Fits: Vacuum Controller Assembly

Model:

DentalEZ/Custom Air/RamVac: Badger

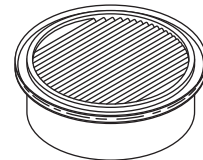

RPI Part #VPE112
OEM Part #004876SP

FILTER ELEMENT

- 5 Micron polyester filter
- Size: 4.00" OD x 1.38" lg.
- Includes: PM Sticker
- Included in: Filter Kit (RPI Part #VPK110)

Fits: Vacuum Controller Assembly

Model:

DentalEZ/Custom Air/RamVac: Badger

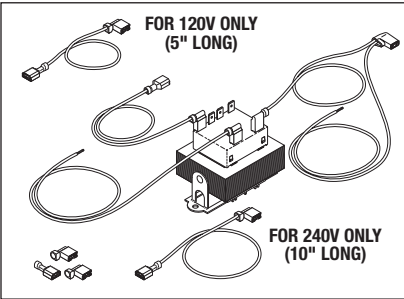

RPI Part #VPT142
OEM Part # See Chart Below

TRANSFORMER

- Primary: 120/208/240VAC; 50/60Hz.
 - Secondary: 24VAC @ 40A
 - Includes all parts as shown
- Fits:** Electrical Control Box

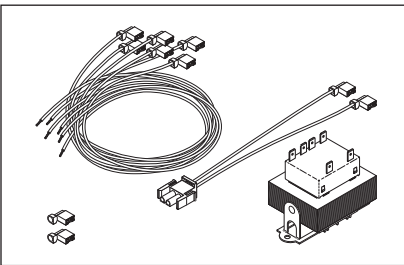

RPI Part #VPT143
OEM Part # See Chart Below

TRANSFORMER

- Primary: 120/208/240VAC; 50/60Hz.
 - Secondary: 24VAC @ 40A
 - Includes all parts as shown
- Fits:** Electrical Control Box

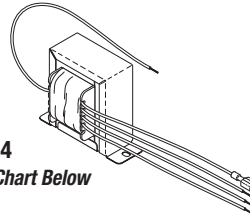

RPI Part #VPT144
OEM Part # See Chart Below

TRANSFORMER

- Primary: 115/230VAC; 50/60Hz.
 - Secondary: 24VAC @ 30A
- Fits:** Electrical Control Box

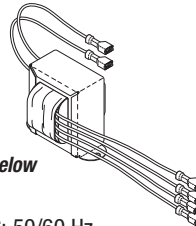

RPI Part #VPT145
OEM Part # See Chart Below

TRANSFORMER

- Primary: 115/230VAC; 50/60 Hz.
 - Secondary: 24VAC @ 40A
 - Auto-Reset thermal protector
- Fits:** Electrical Control Box

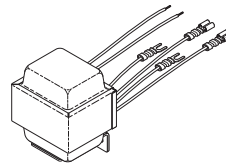

RPI Part #VPT146
OEM Part # See Chart Below

TRANSFORMER

- Primary: Dual 120VAC; 60Hz.
 - Secondary: 24VAC @ 25A
- Fits:** Electrical Control Box

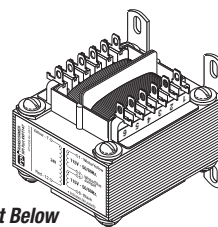

RPI Part #VPT147
OEM Part # See Chart Below

TRANSFORMER

- Primary: Dual 115/230VAC; 50/60Hz.
 - Secondary: 24VAC @ 3.33A
- Fits:** Electrical Control Box

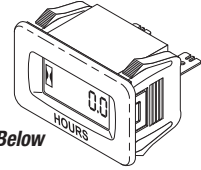

RPI Part #VPM171
OEM Part # See Chart Below

HOUR METER

- AC/DC voltage input
 - Panel cutout: .952" x 1.452"
 - Counts in Tenths, then whole numbers up to 99.999 hours (Non-resettable)
 - Internal lithium battery (Non-replaceable), Battery life of 12 years minimum
- Fits:** Electrical Control Box

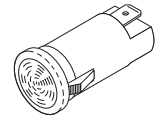

RPI Part #VPL180
OEM Part # See Chart Below

PILOT LIGHT (GREEN)

- 125VAC, 1/3W; 3/16" Tabs
 - .50" dia. mounting hole
- Fits:** Electrical Control Box

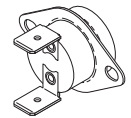

RPI Part #VPT172
OEM Part # See Chart Below

THERMOSTAT

- Opens @ 77°F and Closes at 95°F
 - 125VAC @ 15A / 250VAC @ 10A
 - 1/4" Tabs
- Fits:** Vacuum Base Unit

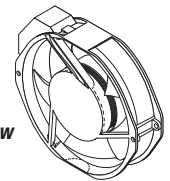

RPI Part #VPF181
OEM Part # See Chart Below

FAN

- 0.196A @ 230VAC
 - Size: 5.91" L x 6.38" H x 1.50" W
 - Aluminum housing; Polycarbonate impeller; Ball bearing construction
 - 3200 RPM; 212 CFM
- Fits:** Vacuum Base Unit

RPI PART #	DESCRIPTION	AIR TECHNIQUES	APOLLO/MIDMARK®	DENTAL EZ®/CUSTOM AIR/RAMVAC	MATRIX/MIDMARK®	MIDMARK®	TECH WEST
VPF181	Fan					20224500 & SEA95540	
VPL180	Pilot Light (Green)					015-1304-00	
VPM171	Hour Meter					20235600	
VPT142	Transformer	54623, 54375, 55866, 55867 & 56325					
VPT143	Transformer		ETR10500			002-1442-00 & 015-196-00	
VPT144	Transformer				77001471 & 77001434		
VPT145	Transformer			64568195			
VPT146	Transformer						PT-100
VPT147	Transformer	53182					
VPT172	Thermostat					65972500	

Call Us Toll-Free Monday-Friday, 8:00 AM-4:30 PM (Pacific Time), (800) 221-9723

Dental Equipment

Air Techniques, Apollo/Midmark®, DentalEZ®/Custom Air/RamVac, Matrix/Midmark®, Midmark® & Tech West

Air Techniques, Apollo/Midmark®, DentalEZ®/Custom Air/RamVac, Matrix/Midmark®, Midmark® & Tech West

DENTAL VACUUM UNITS -

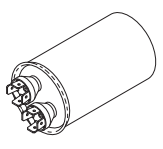

RPI Part #VPC152
OEM Part # See Chart Below
CAPACITOR (15µf, 370VAC)

- Run capacitor
- Size: 1.76" dia. x 2.37/2.95" lg.
- 15µf, 370VAC, 50/60Hz.
- Quad 1/4" Tabs

Fits: Motor Assembly

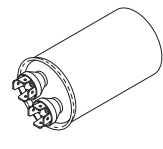

RPI Part #VPC153
OEM Part # See Chart Below
CAPACITOR (25µf, 370VAC)

- Run capacitor
- Size: 1.76" dia. x 2.95/3.00" lg.
- 25µf, 370VAC, 50/60Hz.
- Quad 1/4" Tabs

Fits: Motor Assembly

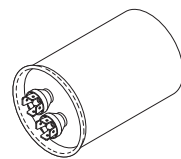

RPI Part #VPC154
OEM Part # See Chart Below
CAPACITOR (50µf, 480VAC)

- Run capacitor
- Size: 2.50" dia. x 3.75" lg.
- 50µf, 480VAC, 50/60Hz.
- Quad 1/4" Tabs
- Note: Fits Model STS-5: Serial #259 and above

Fits: Motor Assembly

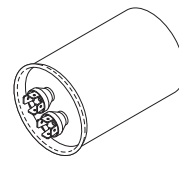

RPI Part #VPC155
OEM Part # See Chart Below
CAPACITOR (60µf, 440VAC)

- Run Capacitor
- Size: 2.50" dia x 3.75" lg.
- 60µf, 440VAC, 50/60Hz.
- Quad 1/4" Tabs
- Note: Fits Model STS-5: Serial #258 and below

Fits: Motor Assembly

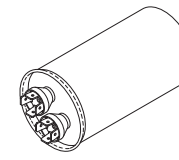

RPI Part #VPC156
OEM Part # See Chart Below
CAPACITOR (60µf, 370VAC)

- Run capacitor
- Size: 2.00" dia. x 3.62"/3.75" lg.
- 60µf, 370VAC, 50/60Hz.
- Quad 1/4" Tabs

Fits: Motor Assembly

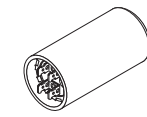

RPI Part #VPC157
OEM Part # See Chart Below
CAPACITOR (189-227µf, 125VAC)

- Start capacitor
- Size: 1.43" dia. x 2.75" lg.
- 189-227µf, 125VAC, 50/60Hz.
- Dual 1/4" Tabs

Fits: Motor Assembly

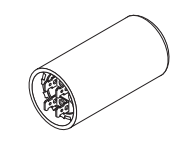

RPI Part #VPC158
OEM Part # See Chart Below
CAPACITOR (250-300µf, 110VAC)

- Start capacitor
- Size: 1.43" dia. x 2.75/3.38" lg.
- 250-300µf, 110VAC, 50/60Hz.
- Dual 1/4" Tabs

Fits: Motor Assembly

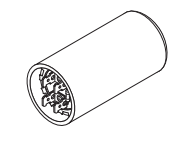

RPI Part #VPC159
OEM Part # See Chart Below
CAPACITOR (295-355µf, 125VAC)

- Start capacitor
- Size: 2.06" dia x 3.37" lg.
- 295-355µf, 125VAC, 50/60Hz.
- Dual 1/4" Tabs
- Includes: 68K bleed resistor installed

Fits: Motor Assembly

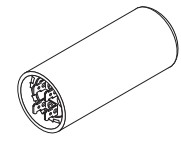

RPI Part #VPC161
OEM Part # See Chart Below
CAPACITOR (378-454µf, 110VAC)

- Start capacitor
- Size: 1.44/1.81" dia. x 3.38/3.65" lg.
- 378-454µf, 110VAC, 50/60Hz.
- Dual 1/4" Tabs

Fits: Motor Assembly

RPI PART #	DESCRIPTION	AIR TECHNIQUES	APOLLO/MIDMARK®	DENTALEZ®/CUSTOM AIR/RAMVAC	MATRIX/MIDMARK®	MIDMARK®	TECH WEST
VPC152	Capacitor (15µf, 370VAC)			No OEM Part # Available			
VPC153	Capacitor (25µf, 370VAC)				77001158		SMC-2
VPC154	Capacitor (50µf, 480VAC)	54323					
VPC155	Capacitor (60µf, 440VAC)	54323					
VPC156	Capacitor (60µf, 370VAC)					10560900	
VPC157	Capacitor (189-227µf, 125VAC)			No OEM Part # Available			
VPC158	Capacitor (250-300µf, 110VAC)	55683	HFA10010				
VPC159	Capacitor (295-355µf, 125VAC)	55684	HFA10040		77001458 & 77001459	77001458 & 77001459	
VPC161	Capacitor (378-454µf, 110VAC)				61894900		

FAX: (818) 882-7028 • E-MAIL: order@rpiparts.com • WEBSITE: www.rpiparts.com

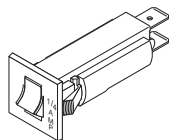

RPI Part #VPB164
OEM Part # See Chart Below

CIRCUIT BREAKER (1/4A)

- 1/4A @ 250VAC
- 1/4" Tabs
- Panel cutout: 5/8" dia.
- Push to reset
- **Important Note:** Verify the amperage of the circuit breaker you are replacing and be sure to use the same amperage.

Fits: Electrical Control Box

Models: Newer models of VacStar 50, VacStar 50H, VacStar 80 & VacStar 80H

Notes: VacStar 50, VacStar 50H, VacStar 80 & VacStar 80H require 2 each.

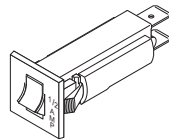

RPI Part #VPB182
OEM Part # See Chart Below

CIRCUIT BREAKER (1/2A)

- 1/2 A @ 250VAC
- 1/4" Tabs
- Panel cutout: 5/8" dia.
- Push to reset

Fits: Electrical Control Box

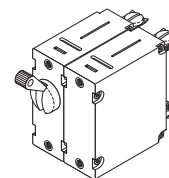

RPI Part #VPB168
OEM Part # See Chart Below

CIRCUIT BREAKER (15A)

- 15A @ 250VAC
- #8-32 screw lugs
- Panel cutout: 9/16" dia.
- On/Off switch

Fits: Electrical Control Box

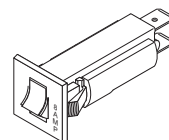

RPI Part #VPB165
OEM Part # See Chart Below

CIRCUIT BREAKER (8A)

- 8A @ 250VAC
- 1/4" Tabs
- Panel cutout: 5/8" dia.
- Push to reset

Fits: Electrical Control Box

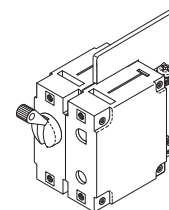

RPI Part #VPB169
OEM Part # See Chart Below

CIRCUIT BREAKER (16A)

- 16A @ 250VAC
- #10-32 screw lugs
- On/Off switch

Fits: Electrical Control Box

Notes: VacStar 50, VacStar 50H, VacStar 80 & VacStar 80H require 2 each.

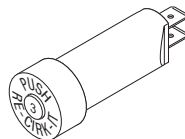

RPI Part #VPB167
OEM Part # See Chart Below

CIRCUIT BREAKER (3A)

- 3A @ 250VAC or 50VDC
- 1/4" Tabs
- Panel cutout: 5/8" dia.
- Push to reset
- **Important Note:** Verify the amperage of the circuit breaker you are replacing and be sure to use the same amperage.

Fits: Electrical Control Box

Models: Older models of VacStar 50, VacStar 50H, VacStar 80 & VacStar 80H

Notes: VacStar 50, VacStar 50H, VacStar 80 & VacStar 80H require 2 each.

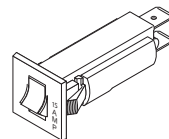

RPI Part #VPB166
OEM Part # See Chart Below

CIRCUIT BREAKER (15A)

- 15A @ 250VAC
- 1/4" Tabs
- Panel cutout: 5/8" dia.
- Push to reset

Fits: Electrical Control Box

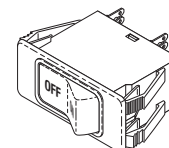

RPI Part #VPS170
OEM Part # See Chart Below

**POWER SWITCH/
 CIRCUIT BREAKER (1/2A)**

- 1/2A @ 250VAC or 50VDC
- Push-in panel mount; Dual blade terminals

Fits: Electrical Control Box

RPI PART #	DESCRIPTION	AIR TECHNIQUES	APOLLO/MIDMARK®	DENTALEZ®/CUSTOM AIR/RAMVAC	MIDMARK®
VPB164	Circuit Breaker (1/4A)	117690			
VPB165	Circuit Breaker (8A)			3801-911	
VPB166	Circuit Breaker (15A)			3801-120	
VPB167	Circuit Breaker (3A)	53180			
VPB168	Circuit Breaker (15A)	54247			
VPB169	Circuit Breaker (16A)	56149 & 56148			
VPB182	Circuit Breaker (1/2A)	117061			
VPS170	Power Switch/Circuit Breaker (1/2A)		ECS10422		ECS10422

Call Us Toll-Free Monday–Friday, 8:00 AM–4:30 PM (Pacific Time), (800) 221-9723

Dental Equipment

Air Techniques, Apollo/Midmark®, DentalEZ®/Custom Air/RamVac, Matrix/Midmark®, Midmark® & Tech West

Air Techniques, Apollo/Midmark®, DentalEZ®/Custom Air/RamVac, Matrix/Midmark®, Midmark® & Tech West

DENTAL VACUUM UNITS -

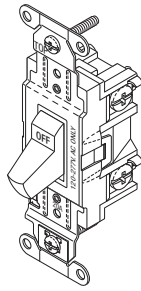

RPI Part #VPS177
OEM Part # See Chart Below

POWER SWITCH

- Toggle switch (On/Off)
- 20A @ 120/277VAC, SPDT
- Screw terminals

Fits: Electrical Control Box

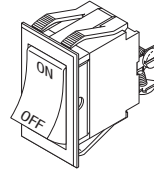

RPI Part #VPS179
OEM Part # See Chart Below

POWER SWITCH

- Rocker switch (On/Off)
- 20A @ 120/277VAC, SPDT
- Screw terminals
- Panel cutout: 1.450" x .830"

Fits: Electrical Control Box

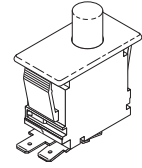

RPI Part #MIS255
OEM Part # See Chart Below

LIMIT SWITCH

- Momentary (on - off)
- 0.1A @ 125VAC, SPDT
- 3/16" tabs
- Panel cutout: 1.125" x .550"

Fits: Front Panel Controls and Front Box Assembly

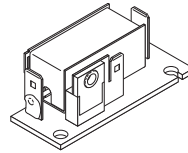

RPI Part #VPS173
OEM Part # See Chart Below

SWITCH (SOLID STATE 115VAC)

- 115VAC motor start switch
- (2) 1/4" and (1) 3/16" Tabs

Fits: Motor

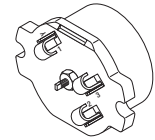

RPI Part #VPS175
OEM Part # See Chart Below

THERMAL OVERLOAD SWITCH

- Automatic reset
- Opens @ 302°F; Closes @ 239°F
- 120VAC @ 40A / 240VAC @ 30A

Fits: Electrical Control Box

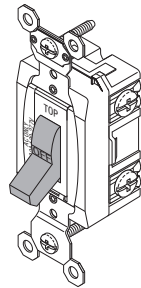

RPI Part #VPS178
OEM Part # See Chart Below

POWER SWITCH

- Toggle switch (On/Off)
- 20A @ 120/277VAC, SPDT
- Screw terminals

Fits: Electrical Control Box

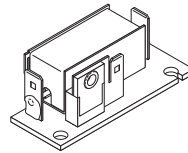

RPI Part #VPS174
OEM Part # See Chart Below

SWITCH (SOLID STATE 220VAC)

- 220VAC motor start switch
- (2) 1/4" and (1) 3/16" Tabs

Fits: Motor

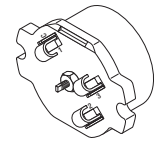

RPI Part #VPS176
OEM Part # See Chart Below

THERMAL OVERLOAD SWITCH

- Automatic reset
- Opens @ 275°F; Closes @ 216°F
- 120VAC @ 40A / 240VAC @ 30A

Fits: Electrical Control Box

RPI PART #	DESCRIPTION	AIR TECHNIQUES	APOLLO/MIDMARK®	MATRIX/MIDMARK®	MIDMARK®
MIS255	Limit Switch				015-1055-00 & 62977400
VPS173	Switch (Solid State 115VAC)	55681			
VPS174	Switch (Solid State 220VAC)	55682			
VPS175	Thermal Overload Switch	55677			
VPS176	Thermal Overload Switch	55698			
VPS177	Power Switch	85838			
VPS178	Power Switch		ECS10417	77001130	77001130
VPS179	Power Switch	55993			

FAX: (818) 882-7028 • E-MAIL: order@rpiparts.com • WEBSITE: www.rpiparts.com

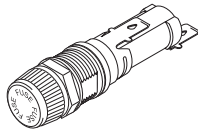

RPI Part #RPH638
OEM Part # See Chart Below

FUSE HOLDER

- Accommodates 1/4" x 1-1/4" fuse
- 20A @ 250VAC
- 3/16" Tabs
- Mounting hole size: .500" dia.
- Includes mounting hardware

Fits: Electrical Control Box

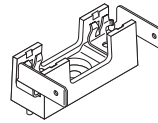

RPI Part #RPH990
OEM Part # See Chart Below

FUSE HOLDER

- Accommodates 1/4" x 1-1/4" fuse
- 30A @ 250VAC
- 1/4" Tabs
- Surface mount

Fits: Electrical Control Box

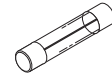

RPI Part #RPF996
OEM Part # See Chart Below

FUSE (150mA, 250V)
1/4" x 1-1/4" - TIME DELAY

- 5 per package
- Type: 3 Glass AG; time delay

Fits: Fuse Holder

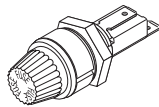

RPI Part #RPH988
OEM Part # See Chart Below

FUSE HOLDER

- Accommodates 1/4" x 1-1/4" fuse
- 20A @ 250VAC
- 3/16" Tabs
- Mounting hole size: .500" dia.
- Includes mounting hardware
- Also available for Tech West Vacuums:
Fuse (1/4A, 250V) (RPI Part #RPF059)

Fits: Electrical Control Box

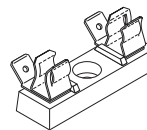

RPI Part #RPH991
OEM Part # See Chart Below

FUSE HOLDER

- Accommodates 1/4" x 1-1/4" fuse
- 30A @ 250VAC
- 1/4" Tabs
- Surface mounting

Fits: Electrical Control Box

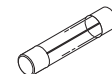

RPI Part #RPF994
OEM Part # See Chart Below

FUSE (3/10A, 250V)
1/4" x 1-1/4" - TIME DELAY

- 5 per package
- Type: 3 Glass AG, time delay

Fits: Fuse Holder

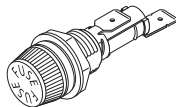

RPI Part #RPH989
OEM Part # See Chart Below

FUSE HOLDER

- Accommodates 1/4" x 1-1/4" fuse
- 20A @ 250VAC
- 1/4" Tabs
- Mounting hole size: .500" dia.
- Includes mounting hardware

Fits: Electrical Control Box

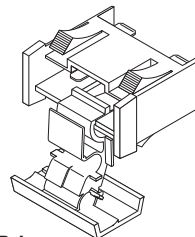

RPI Part #RPH992
OEM Part # See Chart Below

FUSE HOLDER

- Accommodates 1/4" x 1-1/4" fuse
- 15A @ 250VAC
- 1/4" Tabs
- Flip-Top, shock-safe, squeeze cover to open
- Panel cutout: .688" x 1.455"
- Fuse carrier holds spare fuse

Fits: Electrical Control Box

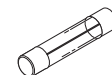

RPI Part #RPF995
OEM Part # See Chart Below

FUSE (1/8A, 250V)
1/4" x 1-1/4" - TIME DELAY

- 5 per Package
- Type: 3 Glass AG; time delay

Fits: Fuse Holder

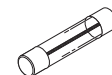

RPI Part #RPF993
OEM Part # See Chart Below

FUSE (3/4A, 250V)
1/4" x 1-1/4" - TIME DELAY

- 5 per package
- Type: 3 Glass AG; time delay

Fits: Fuse Holder

RPI PART #	DESCRIPTION	AIR TECHNIQUES	APOLLO/MIDMARK®	DENTALEZ®/CUSTOM AIR/RAMVAC	MATRX/MIDMARK®	MIDMARK®	TECH WEST
RPF993	Fuse (3/4A, 250V)				77001402		
RPF994	Fuse (3/10A, 250V)			64568131	63882538		
RPF995	Fuse (1/8A, 250V)					015-0346-36	
RPF996	Fuse (150mA, 250V)			64568130			
RPH638	Fuse Holder	90219					
RPH988	Fuse Holder						FH-100
RPH989	Fuse Holder		EMS10935			65927500	
RPH990	Fuse Holder				62977600	015-1534-00	
RPH991	Fuse Holder			64561004			
RPH992	Fuse Holder				61884100		

Call Us Toll-Free Monday-Friday, 8:00 AM-4:30 PM (Pacific Time), (800) 221-9723

Dental Equipment

Air Techniques, Apollo/Midmark®, DentalEZ®/Custom Air/RamVac, Matrix/Midmark®, Midmark® & Tech West

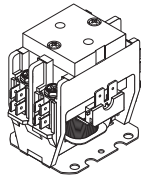

RPI Part #VPR148
OEM Part # See Chart Below

RELAY (ELECTRICAL CONTACTOR)

- Coil: 24VAC, 11 ohms
- 2 pole; Contacts rated at 30A
- 1/4" Tabs

Fits: Vacuum Electrical Control Box

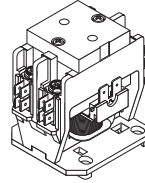

RPI Part #VPR150
OEM Part # See Chart Below

RELAY (ELECTRICAL CONTACTOR)

- Coil: 24VAC, 11 ohms
- 2 pole; Contacts rated at 30A
- 1/4" Quad Tabs
- DIN mounting bracket (35mm Style)

Fits: Vacuum Electrical Control Box

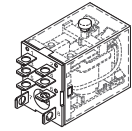

RPI Part #VPR162
OEM Part # See Chart Below

RELAY

- Coil: 24VAC, 180 ohms
- DPDT rated at 10Amps
- Plug-in or solder terminals
- LED indicator and Push-to-Test button
- Also available: Relay Socket (RPI Part #VPS163)

Fits: Vacuum Electrical Control Box

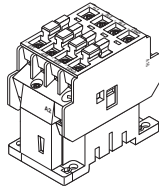

RPI Part #VPR149
OEM Part # See Chart Below

RELAY (ELECTRICAL CONTACTOR)

- Coil: 24VDC
- 3 pole; Contacts rated at 30A
- Screw terminals

Fits: Vacuum Electrical Control Box

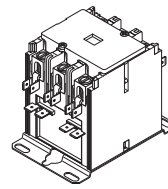

RPI Part #VPR151
OEM Part # See Chart Below

RELAY (ELECTRICAL CONTACTOR)

- Coil: 24VAC, 7 ohms
- 3 pole; Contacts rated at 40A
- 1/4" Dual Tabs

Fits: Vacuum Electrical Control Box

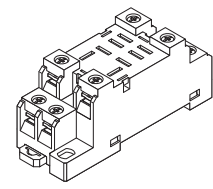

RPI Part #VPS163
OEM Part # See Chart Below

RELAY SOCKET

- Accommodates track or screw mount
- Also available: Relay (RPI Part #VPR162)

Fits: Vacuum Electrical Control Box

RPI PART #	DESCRIPTION	AIR TECHNIQUES	APOLLO/MIDMARK®	DENTALEZ®/CUSTOM AIR/RAMVAC	MATRIX/MIDMARK®	MIDMARK®	TECH WEST
VPR148	Relay (Electrical Contractor)	55857 & 55407		64568133		015-2817-00	PR-100
VPR149	Relay (Electrical Contractor)				62899901		
VPR150	Relay (Electrical Contractor)		No OEM Part # Available			015-2029-00	
VPR151	Relay (Electrical Contractor)	54498					
VPR162	Relay					015-2018-00	
VPS163	Relay Socket					015-2020-00	

NOTES: _____

Models: DV5, DV7, DV10, DV12, SC3, SC5, SC7, SC10, & SC12

New PM Kits to fit

A-dec®/Dean®
Dental Compressors
and Dental Vacuum Units!

PM Kits to fit A-dec/Dean Dental Compressors

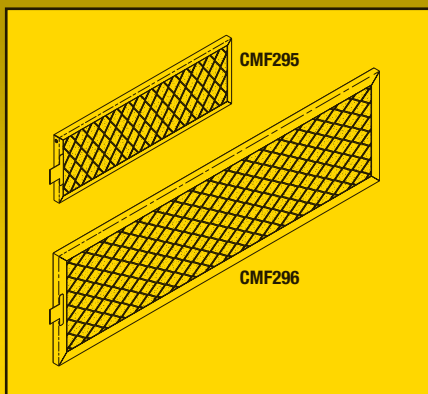

RPI Part #CMK293
OEM Part #A0050

COMPRESSOR PM KIT

- For Oil-less dual, triple and quad headed compressors
- All parts also sold separately
- Includes all parts as shown plus a PM Sticker and PM checklist
- See *the RPI Advantage* below

Fits: Compressor Body
Models: SC3, SC5 & SC7

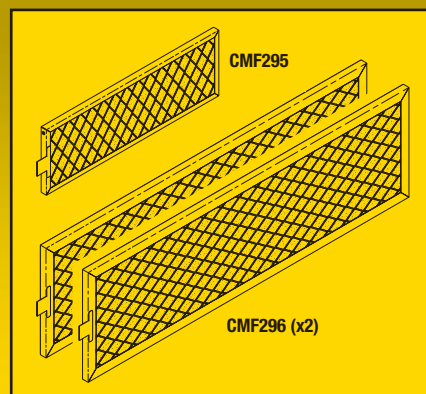

RPI Part #CMK294
OEM Part #A0150

COMPRESSOR PM KIT

- For Oil-less 5 and 6 headed compressors
- All parts also sold separately
- Includes all parts as shown plus a PM Sticker and PM checklist
- See *the RPI Advantage* below

Fits: Compressor Body
Models: SC10 & SC12

PM Kit to fit A-dec/Dean Dental Vacuum Units



RPI Part #VPK183
OEM Part #A0049

VACUUM PM KIT

- **Service Tip:** Air filter life depends on vacuum usage, nature of environment, and amount of aspirated material. Inspect air filter every 1,000 hours and replace every 2,000 hours or when visibly dirty.
- All parts also sold separately
- Includes all parts as shown plus a PM Sticker and PM checklist
- See *the RPI Advantage* below

Fits: Inside Separator Tank and Drain Assembly
Models: DV5, DV7, DV10 & DV12

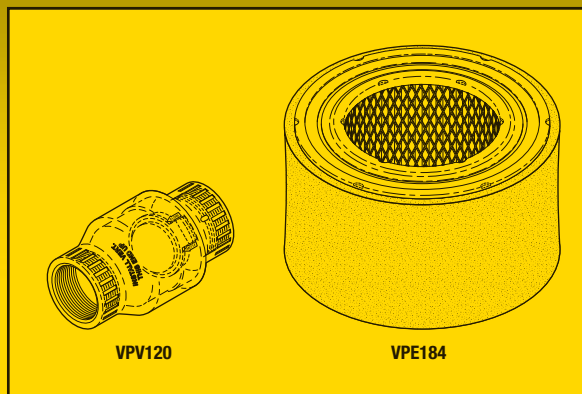

RPI Filters and PM Kits include a PM Sticker that can be attached to the compressor or vacuum unit for recording the date that the filters were replaced. It's the RPI Advantage!



replacement parts industries, inc.

CALL (800) 221-9723 • FAX (818) 882-7028 • EMAIL order@riparts.com • WEBSITE www.riparts.com

The above parts are manufactured by Replacement Parts Industries, Inc. to fit the equipment noted. All product names used in this document are trademarks or registered trademarks of their respective holders. 2010AD Show 02/21

Air Filters to fit A-dec/Dean Dental Compressors!

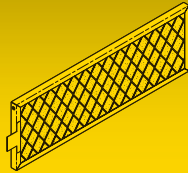

RPI Part #CMF295

OEM Part # (OEM Part # Not Available)

AIR FILTER

- Size: 9.87" lg. x 3.25" wide
- Material: 60 PPI Quadrafoam, color black, aluminum frame and stainless steel mesh
- Included in: Compressor PM Kit (RPI Part #CMK293) and Compressor PM Kit (RPI Part #CMK294)
- See *the RPI Advantage* on reverse side

Fits: Compressor Body

Models: SC3, SC5, SC7, SC10 & SC12

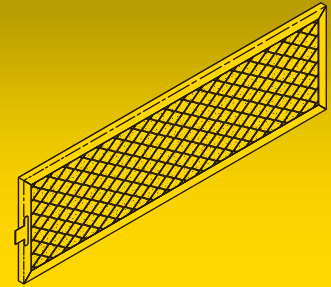

RPI Part #CMF296

OEM Part # (OEM Part # Not Available)

AIR FILTER

- Size: 18.44" lg. x 5.44" wide
- Material: 25 PPI Quadrafoam, color green, aluminum frame and stainless steel mesh
- Included in: Compressor PM Kit (RPI Part #CMK293) and Compressor PM Kit (RPI Part #CMK294)
- See *the RPI Advantage* on reverse side

Fits: Compressor Body

Models: SC3, SC5, SC7, SC10 & SC12

New Parts to fit A-dec/Dean Dental Compressors & Vacuums!

ADDRESS SERVICES REQUESTED

PERMIT NO. 2399
VAN NUYS, CA
U.S. POSTAGE PAID
PRESORTED STANDARD

625 Cochran Street • Simi Valley, California • 93065
replacement parts industries, inc.



Parts to fit A-dec/Dean Dental Vacuum Units!

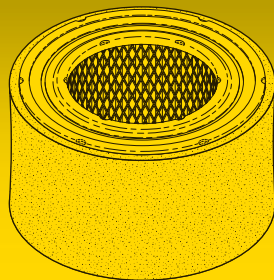

RPI Part #VPE184

OEM Part # (OEM Part # Not Available)

FILTER ELEMENT

- 5 micron
- Size 7.88" OD x 4.81" lg.
- Included in: Vacuum PM Kit (RPI Part #VPK183)
- See *the RPI Advantage* on reverse side

Fits: Inside Separator Tank

Models: DV5, DV7, DV10 & DV12

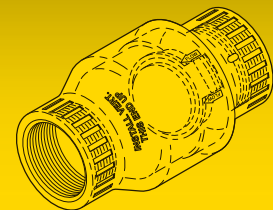

RPI Part #VPV120

OEM Part # (OEM Part # Not Available)

CHECK VALVE (1-1/2")

- Ports: 1-1/2" FPT
- Material: Clear PVC
- Size: 3.38" dia. x 5.75" lg.
- Included in: Vacuum PM Kit (RPI Part #VPK183)

Fits: Inside Separator Tank and Drain Assembly

Models: DV5, DV7, DV10 & DV12

DentalEZ®/Custom Air/RamVac, MatrX Medical, MatrX/Midmark® & Midmark®



PM Kits and More to fit DENTAL VACUUM UNITS!



RPI Part #VPK185
OEM Part #77000796
(Filter Element) &
77007063 (Purge Muffler)

VACUUM PM KIT

- For single headed vacuum systems
- Includes: (1 pkg) Filter Element (RPI Part #VPE188), Purge Muffler (RPI Part #VPM190), PM sticker, and PM checklist
- Also available: Filter Cap (RPI Part #VPC189)

Fits: Vacuum Pump

Models: **Midmark:** PM-1;
Matrx Medical • MatrX/Midmark: PM-75



RPI Part #VPK187
OEM Part #77000796
(Filter Element) &
77007063 (Purge Muffler)

VACUUM PM KIT

- For triple headed vacuum systems
- Includes: (3 pkgs) Filter Element (RPI Part #VPE188), (3) Purge Muffler (RPI Part #VPM190), PM sticker, and PM checklist
- Also available: Filter Cap (RPI Part #VPC189)

Fits: Vacuum Pump

Models: **Midmark:** PM-4;
Matrx Medical • MatrX/Midmark: PM-75-3



RPI Part #VPK186
OEM Part #77000796
(Filter Element) &
77007063 (Purge Muffler)

VACUUM PM KIT

- For dual headed vacuum systems
- Includes: (2 pkgs) Filter Element (RPI Part #VPE188), (2) Purge Muffler (RPI Part #VPM190), PM sticker, and PM checklist
- Also available: Filter Cap (RPI Part #VPC189)

Fits: Vacuum Pump

Models: **Midmark:** PM-3;
Matrx Medical • MatrX/Midmark: PM-75-2



RPI Part #VPE188
OEM Part #77000796

FILTER ELEMENT

- 2 per package
- Size: 1.25" OD x 2.19" lg.
- Felt elements
- Includes: (2) Filters, (2 pcs) O-Ring (RPI Part #RX0086) and PM sticker
- Also available: Filter Cap (RPI Part #VPC189)
- See **Note** below for quantity required for each model

Fits: Vacuum Pump

Models: **Midmark:** PM-1, PM-3 & PM-4;
Matrx Medical • MatrX/Midmark: PM-75, PM-75-2 & PM-75-3



RPI Part #VPM190
OEM Part #77007063

PURGE MUFFLER

- Port Size: 3/8" MPT
- Size: 11/16" hex x 1-1/2" lg.
- Material: 40 micron sintered bronze

Fits: Vacuum Pump

Models: **Midmark:** PM-1, PM-3 & PM-4;
Matrx Medical • MatrX/Midmark: PM-75,
PM-75-2 & PM-75-3



RPI Part #RX0086
OEM Part #7700789

O-RING

- 2 per package
- Size: 1.362" ID x 1.568" OD x .103" C/S
- Material: Nitrile (Buna-N); Duro 70

Fits: Vacuum Pump

Models: **Midmark:** PM-1, PM-3 & PM-4;
Matrx Medical • MatrX/Midmark: PM-75,
PM-75-2 & PM-75-3



RPI Part #VPC189
OEM Part #77000788

FILTER CAP

- 2 per package
- Also available: O-Ring (RPI Part #RX0086)
- See **Notes** below for quantity required for each model
- Holds Filter Element (RPI Part #VPE188)

Fits: Vacuum Pump

Models: **Midmark:** PM-1, PM-3 & PM-4;
Matrx Medical • MatrX/Midmark: PM-75,
PM-75-2 & PM-75-3

Note: **Midmark:** PM-1 requires 1 package, PM-3 requires 2 packages, PM-4 requires 3 packages;
Matrx/Midmark: PM-75 requires 1 package, PM-75-2 requires 2 packages, and PM-75-3 requires 3 packages.



replacement parts industries, inc. A Healthcare Components Group Company
CALL (800) 221-9723 • FAX (818) 882-7028 • EMAIL order@rpiparts.com • WEBSITE www.rpiparts.com

The above parts are manufactured by Replacement Parts Industries, Inc. to fit the equipment noted. All product names used in this document are trademarks or registered trademarks of their respective holders. 2007VP Show 03/22



RPI Part #VPK192
OEM Part # (No OEM Part # Available)

VACUUM PM KIT

- Includes: Oil Filter Media Kit (RPI Part #VPK193), Muffler (RPI Part #VPM194), Instant Gasket Sealant (RPI Part #RXS087), (3) Synthetic Oil (Mobil 1®) (RPI Part #VPL131), (1 pkg) Disposal Bag (RPI Part #RPB838), (1 pkg) Absorbent Pad (RPI Part #RPP958), and PM sticker
- Also available: Grommet (RPI Part #VPG205)

Fits: Oil Reservoir
Models: *DentalEZ/Custom Air/RamVac:* Bulldog 550, Bulldog QT1, Bulldog QT2 & Bulldog QT3



RPI Part #VPK196
OEM Part # (No OEM Part # Available)

VACUUM PM KIT

- Includes: Oil Filter Media Kit (RPI Part #VPK197), Muffler (RPI Part #VPM198), Instant Gasket Sealant (RPI Part #RXS087), (5) Synthetic Oil (Mobil 1®) (RPI Part #VPL131), (1 pkg) Disposal Bag (RPI Part #RPB838), (1 pkg) Absorbent Pad (RPI Part #RPP958), and PM Sticker
- Also available: Grommet (RPI Part #VPG205), Float Switch (Low Oil) (RPI Part #VPS201), and Float Switch (Water In Oil) (RPI Part #VPS202)

Fits: Oil Reservoir
Models: *DentalEZ/Custom Air/RamVac:* Bison 3 & Bison 5

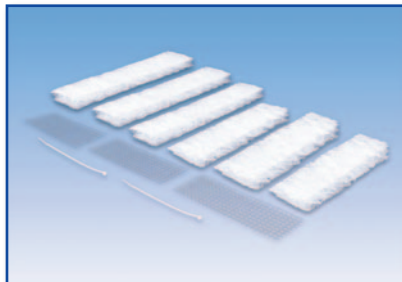

RPI Part #VPK193
OEM Part #003727SP

OIL FILTER MEDIA KIT

- Includes: Filter media, galvanized mesh, (2 pcs) Cable Tie (RPI Part #RPT661), and PM sticker
- Included in: PM Kit (RPI Part #VPK192)

Fits: Lid Assembly
Models: *DentalEZ/Custom Air/RamVac:* Bulldog 550, Bulldog QT1, Bulldog QT2 & Bulldog QT3



RPI Part #VPM198
OEM Part #003684SP

MUFLER

- Material: Zinc plated steel case, stainless steel screen mesh
- Port Size: 2" MPT; Size: 2-3/8" hex x 5-19/32" lg.
- Includes: Mounting screw
- Included in: PM Kit (RPI Part #'s VPK196 & VPK200)

Fits: Reservoir
Models: *DentalEZ/Custom Air/RamVac:* Bison 3, Bison 5, Bison 7 & Bison 9



RPI Part #VPM194
OEM Part #003682SP

MUFLER

- Material: Zinc plated steel case, stainless steel screen mesh
- Port Size: 1-1/2" MPT; Size: 2.00" hex x 4-15/16" lg.
- Includes: Mounting screw
- Included in: PM Kit (RPI Part #VPK192)

Fits: Reservoir
Models: *DentalEZ/Custom Air/RamVac:* Bulldog 550, Bulldog QT1, Bulldog QT2 & Bulldog QT3

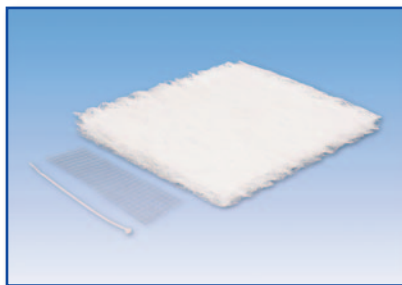

RPI Part #VPK197
OEM Part #003729SP

OIL FILTER MEDIA KIT

- Includes: Filter media, galvanized mesh, (1 pc) Cable Tie (RPI Part #RPT661), and PM sticker
- Included in: PM Kit (RPI Part #VPK196) and PM Kit (RPI Part #VPK200)

Fits: Lid, Oil Reservoir Assembly
Models: *DentalEZ/Custom Air/RamVac:* Bison 3, Bison 5, Bison 7 & Bison 9

RPI Part #RPB838
OEM Part # (No OEM Part # Available)

DISPOSAL BAG

- 3 per package
 - Used oil collection and disposal bag
- Models:** *DentalEZ/Custom Air/RamVac:* Bulldog 550, Bulldog QT1, Bulldog QT2, Bulldog QT3, Bison 3, Bison 5, Bison 7 & Bison 9





RPI Part #VPK200
OEM Part # (No OEM Part # Available)

VACUUM PM KIT

- Includes: Oil Filter Media Kit (RPI Part #VPK197), (2) Muffler (RPI Part #VPM198), Instant Gasket Sealant (RPI Part #RXS087), (5) Synthetic Oil (Mobil 1®) (RPI Part #VPL131), (1 pkg) Disposal Bag (RPI Part #RPB838), (1 pkg) Absorbent Pad (RPI Part #RPP958), and PM Sticker
- Also available: Grommet (RPI Part #VPG205), Float Switch (Low Oil) (RPI Part #VPS201), and Float Switch (Water In Oil) (RPI Part #VPS202)

Fits: Oil Reservoir
Models: *DentalEZ/Custom Air/RamVac:* Bison 7 & Bison 9

RPI Part #RXS087
OEM Part # (No OEM Part # Available)
Industry Part #Loctite 40478



INSTANT GASKET SEALANT

- 3.04 fl. oz. (90ml) aerosol can
- Material: Black silicone; Temperature range: -65° to 450°F
- Included in: PM Kit (RPI Part #'s VPK192, VPK196 & VPK200)

Fits: Oil Reservoir Lid Assembly
Models: *DentalEZ/Custom Air/RamVac:* Bulldog 550, Bulldog QT1, Bulldog QT2, Bulldog QT3, Bison 3, Bison 5, Bison 7 & Bison 9



RPI Part #VPL131
OEM Part # (No OEM Part # Available)

SYNTHETIC OIL (MOBIL 1®)

- Size: 1 Quart (.946 Liter) bottle
- 15W-50 (ISO grade 32)
- Also available: Synthetic Oil (Mobil 1®) (Case of 6) (RPI Part #VPL132)

Fits: Vacuum Unit
Models: *DentalEZ/Custom Air/RamVac:* Bulldog 550, Bulldog QT1, Bulldog QT2, Bulldog QT3, Bison 3, Bison 5, Bison 7 & Bison 9



RPI Part #RPP958
OEM Part # (No OEM Part # Available)

ABSORBENT PAD

- 3 per package; Size: 9-1/4" x 14-1/2"
- Can be used for oil drip collection and spills

Models: *DentalEZ/Custom Air/RamVac:* Bulldog 550, Bulldog QT1, Bulldog QT2, Bulldog QT3, Bison 3, Bison 5, Bison 7 & Bison 9

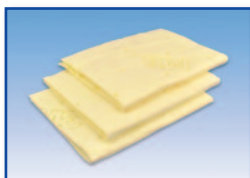

RPI Part #VPG205
OEM Part #000473

GROMMET

- 1-5/8" OD x 7/8" ID x 7/16" Thk.
- 1-1/4" dia. x .062" Panel Cutout
- Material: Nitrile (Buna-N)

Fits: Reservoir Tank/Moisture Alarm assemblies
Models: *DentalEZ/Custom Air/RamVac:* Bison 3, Bison 5, Bison 7 & Bison 9



RPI Part #VPS201
OEM Part #005093

FLOAT SWITCH (LOW OIL)

- Ports: 1/8" MPT; 36" Leads
- Vertical mount, N.C.
- Also available: Float Switch (Water In Oil) (RPI Part #VPS202), Pipe Sealant 567 (RPI Part #RPA459), Butt Connector (RPI Part #RPT011), Instant Gasket Sealant (RPI Part #RXS087), Disposal Bag (RPI Part #RPB838), Absorbent Pad (RPI Part #RPP958) and Synthetic Oil (Mobil 1®) (RPI Part #VPL131)

Fits: Oil Reservoir
Models: *DentalEZ/Custom Air/RamVac:* Bison 3, Bison 5, Bison 7 & Bison 9



RPI Part #VPS202
OEM Part #005094

FLOAT SWITCH (WATER IN OIL)

- Ports: 1/8" MPT; 36" Leads
- Vertical mount, N.O.
- Also available: Float Switch (Low Oil) (RPI Part #VPS201), Pipe Sealant 567 (RPI Part #RPA459), Butt Connector (RPI Part #RPT011), Instant Gasket Sealant (RPI Part #RXS087), Disposal Bag (RPI Part #RPB838), Absorbent Pad (RPI Part #RPP958) and Synthetic Oil (Mobil 1®) (RPI Part #VPL131)

Fits: Oil Reservoir
Models: *DentalEZ/Custom Air/RamVac:* Bison 3, Bison 5, Bison 7 & Bison 9

NEW PM KITS AND MORE FOR DENTAL VACUUM UNITS!

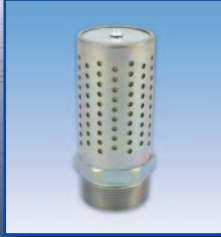

NEW PM KITS AND MORE TO FIT DENTAL VACUUM UNITS!

ADDRESS SERVICES REQUESTED

RESORTED STANDARD
U.S. POSTAGE PAID
VAN NUYS, CA
PERMIT NO. 2399

replacement parts industries, inc.
625 Cochran Street • Simi Valley, California • 93065

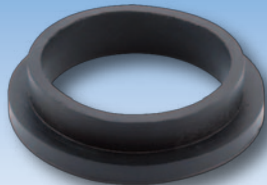

RPI Part #VPG195
OEM Part #000505

SPUD GASKET

- 2" round gasket
- Material: Black rubber
- Also available: Filter Kit (RPI Part #VPK113), Filter Kit (RPI Part #VPK117), Filter Element (RPI Part #VPE114), Filter Element (RPI Part #VPE115), and Filter Element (RPI Part #VPE118)

Fits: Vacuum Controller Assembly

Models: *DentalEZ/Custom Air/RamVac:* Bulldog 550, Bulldog QT1, Bulldog QT2, Bulldog QT3, Bison 3, Bison 5, Bison 7 & Bison 9



RPI Part #VPS191
OEM Part #30126601

VACUUM SWITCH

- 115/230VAC
- Contacts: N.C. DPST
- Factory set to: On @ 13"Hg. - Off @ 20"Hg.
- 1/4-18 NPSF Input Port - 3 Knock-outs for 1/2" NPT Conduit
- Also available: Pipe Sealant 567 (RPI Part #RPA459)

Fits: Vacuum Pump

Models: *Midmark:* PM-1, PM-3 & PM-4;

Matrx Medical • Matrx/Midmark: PM-75, PM-75-2 & PM-75-3

DentalEZ®/Custom Air/RamVac, MatrX Medical, MatrX/Midmark® & Midmark®



NEW MOISTURE ALARM ASSEMBLIES, PM KITS & MORE TO FIT DENTAL VACCUUM UNITS!

RPI Part #VPK185
OEM Part #77000796 (Filter Element) & 77007063 (Purge Muffler)

VACUUM PM KIT

- For single headed vacuum systems
- Includes: (1 pkg) Filter Element (RPI Part #VPE188), Purge Muffler (RPI Part #VPM190), PM sticker, and PM checklist

Fits: Vacuum Pump

Models: Midmark: PM-1;

Matrx Medical • MatrX/Midmark: PM-75



RPI Part #VPK186
OEM Part #77000796 (Filter Element) & 77007063 (Purge Muffler)

VACUUM PM KIT

- For dual headed vacuum systems
- Includes: (2 pkgs) Filter Element (RPI Part #VPE188), (2) Purge Muffler (RPI Part #VPM190), PM sticker, and PM checklist

Fits: Vacuum Pump

Models: Midmark: PM-3;

Matrx Medical • MatrX/Midmark: PM-75-2



RPI Part #VPK187
OEM Part #77000796 (Filter Element) & 77007063 (Purge Muffler)

VACUUM PM KIT

- For triple headed vacuum systems
- Includes: (3 pkgs) Filter Element (RPI Part #VPE188), (3) Purge Muffler (RPI Part #VPM190), PM sticker, and PM checklist

Fits: Vacuum Pump

Models: Midmark: PM-4;

Matrx Medical • MatrX/Midmark: PM-75-3



RPI Part #VPE188
OEM Part #77000796

FILTER ELEMENT

- 2 per package
- Size: 1.25" OD x 2.19" lg.; Felt elements
- Includes: (2) Filters, (1 pkg) O-Ring (RPI Part #RX0086) and PM sticker
- See **Note Regarding Quantities Required** for each model to the right

Fits: Vacuum Pump

Models: Midmark: PM-1, PM-3 & PM-4;

Matrx Medical • MatrX/Midmark: PM-75, PM-75-2 & PM-75-3



Also Available ...

RPI Part #VPC189
OEM Part #77000788

FILTER CAP

- 2 per package
 - Also available: O-Ring (RPI Part #RX0086)
 - See **Note Regarding Quantities Required** for each model below
 - Holds Filter Element (RPI Part #VPE188)
- Fits:** Vacuum Pump
Models: Midmark: PM-1, PM-3 & PM-4;
 Matrx Medical • MatrX/Midmark: PM-75, PM-75-2 & PM-75-3



x2

RPI Part #RX0086
OEM Part #7700789

O-RING

- 2 per package
 - Size: 1.362" ID x 1.568" OD x .103" C/S
 - Material: Nitrile (Buna-N); Duro 70
 - See **Note Regarding Quantities Required** for each model below
- Fits:** Vacuum Pump
Models: Midmark: PM-1, PM-3 & PM-4;
 Matrx Medical • MatrX/Midmark: PM-75, PM-75-2 & PM-75-3



x2

RPI Part #VPM190
OEM Part #77007063

PURGE MUFFLER

- Port Size: 3/8" MPT
- Size: 11/16" hex x 1-1/2" lg.
- Material: 40 micron sintered bronze
- See **Note Regarding Quantities Required** for each model below

Fits: Vacuum Pump

Models: Midmark: PM-1, PM-3 & PM-4;

Matrx Medical • MatrX/Midmark: PM-75, PM-75-2 & PM-75-3



Note Regarding Quantities Required

OEM	Model	Quantity Required
Midmark	PM-1	1 package
Midmark	PM-3	2 packages
Midmark	PM-4	3 packages
Matrx/Midmark	PM-75	1 package
Matrx/Midmark	PM-75-2	2 packages
Matrx/Midmark	PM-75-3	3 packages



replacement parts industries, inc. A Healthcare Components Group Company
 CALL (800) 221-9723 • FAX (818) 882-7028 • EMAIL order@rpiparts.com • WEBSITE www.rpiparts.com

The above parts are manufactured by Replacement Parts Industries, Inc. to fit the equipment noted. All product names used in this document are trademarks or registered trademarks of their respective holders. 2007VP RD2 Show 05/22



RPI Part #VPK192
OEM Part # (No OEM Part # Available)

VACUUM PM KIT

- Includes: Oil Filter Media Kit (RPI Part #VPK193), Muffler (RPI Part #VPM194), Instant Gasket Sealant (RPI Part #RXS087), (3) Synthetic Oil (Mobil 1®) (RPI Part #VPL131), (1 pkg) Disposal Bag (RPI Part #RPB838), (1 pkg) Absorbent Pad (RPI Part #RPP958), and PM sticker
- Also available: Grommet (RPI Part #VPG205) and Moisture Alarm Assembly (RPI Part #VPA203)

Fits: Oil Reservoir
Models: *DentalEZ/Custom Air/RamVac:* Bulldog 550, Bulldog QT1, Bulldog QT2 & Bulldog QT3



RPI Part #VPK196
OEM Part # (No OEM Part # Available)

VACUUM PM KIT

- Includes: Oil Filter Media Kit (RPI Part #VPK197), Muffler (RPI Part #VPM198), Instant Gasket Sealant (RPI Part #RXS087), (5) Synthetic Oil (Mobil 1®) (RPI Part #VPL131), (1 pkg) Disposal Bag (RPI Part #RPB838), (1 pkg) Absorbent Pad (RPI Part #RPP958), and PM Sticker
- Also available: Grommet (RPI Part #VPG205), Moisture Alarm Assembly (RPI Part #VPA204), Float Switch (Low Oil) (RPI Part #VPS201), and Float Switch (Water In Oil) (RPI Part #VPS202)

Fits: Oil Reservoir
Models: *DentalEZ/Custom Air/RamVac:* Bison 3 & Bison 5

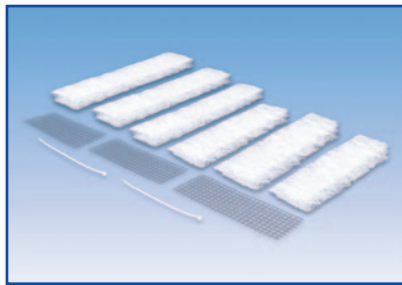

RPI Part #VPK193
OEM Part #003727SP

OIL FILTER MEDIA KIT

- Includes: Filter media, galvanized mesh, (2 pcs) Cable Tie (RPI Part #RPT661), and PM sticker
- Included in: PM Kit (RPI Part #VPK192)

Fits: Lid Assembly
Models: *DentalEZ/Custom Air/RamVac:* Bulldog 550, Bulldog QT1, Bulldog QT2 & Bulldog QT3

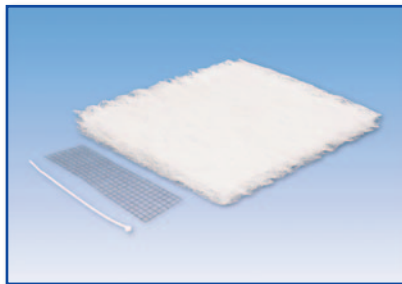

RPI Part #VPK197
OEM Part #003729SP

OIL FILTER MEDIA KIT

- Includes: Filter media, galvanized mesh, (1 pc) Cable Tie (RPI Part #RPT661), and PM sticker
- Included in: PM Kit (RPI Part #VPK196) and PM Kit (RPI Part #VPK200)

Fits: Lid, Oil Reservoir Assembly
Models: *DentalEZ/Custom Air/RamVac:* Bison 3, Bison 5, Bison 7 & Bison 9

RPI Part #VPM198
OEM Part #003684SP

MUFFLER

- Material: Zinc plated steel case, stainless steel screen mesh
- Port Size: 2" MPT; Size: 2-3/8" hex x 5-19/32" lg.
- Includes: Mounting screw
- Included in: PM Kit (RPI Part #'s VPK196 & VPK200)

Fits: Reservoir
Models: *DentalEZ/Custom Air/RamVac:* Bison 3, Bison 5, Bison 7 & Bison 9

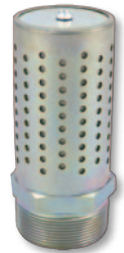

RPI Part #VPM194
OEM Part #003682SP

MUFFLER

- Material: Zinc plated steel case, stainless steel screen mesh
- Port Size: 1-1/2" MPT; Size: 2.00" hex x 4-15/16" lg.
- Includes: Mounting screw
- Included in: PM Kit (RPI Part #VPK192)

Fits: Reservoir
Models: *DentalEZ/Custom Air/RamVac:* Bulldog 550, Bulldog QT1, Bulldog QT2 & Bulldog QT3



RPI Part #RPB838
OEM Part # (No OEM Part # Available)

DISPOSAL BAG

- 3 per package
 - Used oil collection and disposal bag
- Models:** *DentalEZ/Custom Air/RamVac:* Bulldog 550, Bulldog QT1, Bulldog QT2, Bulldog QT3, Bison 3, Bison 5, Bison 7 & Bison 9





RPI Part #VPK200
OEM Part # (No OEM Part # Available)

VACUUM PM KIT

- Includes: Oil Filter Media Kit (RPI Part #VPK197), (2) Muffler (RPI Part #VPM198), Instant Gasket Sealant (RPI Part #RXS087), (5) Synthetic Oil (Mobil 1®) (RPI Part #VPL131), (1 pkg) Disposal Bag (RPI Part #RPB838), (1 pkg) Absorbent Pad (RPI Part #RPP958), and PM Sticker
- Also available: Grommet (RPI Part #VPG205), Moisture Alarm Assembly (RPI Part #VPA204), Float Switch (Low Oil) (RPI Part #VPS201), and Float Switch (Water In Oil) (RPI Part #VPS202)

Fits: Oil Reservoir
Models: *DentalEZ/Custom Air/RamVac:* Bison 7 & Bison 9

RPI Part #RXS087
OEM Part # (No OEM Part # Available)
Industry Part #Loctite 40478

INSTANT GASKET SEALANT

- 3.04 fl. oz. (90ml) aerosol can
- Material: Black silicone; Temperature range: -65° to 450°F
- Included in: PM Kit (RPI Part #'s VPK192, VPK196 & VPK200)

Fits: Oil Reservoir Lid Assembly
Models: *DentalEZ/Custom Air/RamVac:* Bulldog 550, Bulldog QT1, Bulldog QT2, Bulldog QT3, Bison 3, Bison 5, Bison 7 & Bison 9



RPI Part #VPL131
OEM Part # (No OEM Part # Available)

SYNTHETIC OIL (MOBIL 1®)

- Size: 1 Quart (.946 Liter) bottle
- 15W-50 (ISO grade 32)
- Also available: Synthetic Oil (Mobil 1®) (Case of 6) (RPI Part #VPL132)

Fits: Vacuum Unit
Models: *DentalEZ/Custom Air/RamVac:* Bulldog 550, Bulldog QT1, Bulldog QT2, Bulldog QT3, Bison 3, Bison 5, Bison 7 & Bison 9



RPI Part #RPP958
OEM Part # (No OEM Part # Available)

ABSORBENT PAD

- 3 per package; Size: 9-1/4" x 14-1/2"
- Can be used for oil drip collection and spills

Models: *DentalEZ/Custom Air/RamVac:* Bulldog 550, Bulldog QT1, Bulldog QT2, Bulldog QT3, Bison 3, Bison 5, Bison 7 & Bison 9

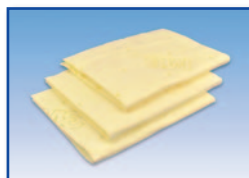

RPI Part #VPA203
OEM Part #002854

MOISTURE ALARM ASSEMBLY

- Material: Urethane housing; 23-1/4" lg. cable
- Includes: Grommet (RPI Part #VPG205)

Fits: Vacuum Controller Enclosure
Models: *DentalEZ/Custom Air/RamVac:* Bulldog 550, Bulldog QT1, Bulldog QT2 & Bulldog QT3



RPI Part #VPA204
OEM Part #002855

MOISTURE ALARM ASSEMBLY

- Material: Urethane housing; 14-1/4" lg. cable
- Includes: Grommet (RPI Part #VPG205)

Fits: Vacuum Controller Enclosure
Models: *DentalEZ/Custom Air/RamVac:* Bison 3, Bison 5, Bison 7 & Bison 9



RPI Part #VPG205
OEM Part #000473

GROMMET

- Size: 1-5/8" OD x 7/8" ID x 7/16" Thk.
- Panel Cutout: 1-1/4" dia. x .062" Thk.
- Material: Nitrile (Buna-N)
- Included in: Moisture Alarm Assembly (RPI Part #VPA203) and Moisture Alarm Assembly (RPI Part #VPA204)

Fits: Reservoir Tank/Moisture Alarm assemblies
Models: *DentalEZ/Custom Air/RamVac:* Bison 3, Bison 5, Bison 7, Bison 9, Bulldog 550, Bulldog QT1, Bulldog QT2 & Bulldog QT3



RPI Part #VPS201
OEM Part #005093

FLOAT SWITCH (LOW OIL)

- Ports: 1/8" MPT; 36" Leads
- Vertical mount, N.C.

Fits: Oil Reservoir
Models: *DentalEZ/Custom Air/RamVac:* Bison 3, Bison 5, Bison 7 & Bison 9



RPI Part #VPS202
OEM Part #005094

FLOAT SWITCH (WATER IN OIL)

- Ports: 1/8" MPT; 36" Leads
- Vertical mount, N.O.

Fits: Oil Reservoir
Models: *DentalEZ/Custom Air/RamVac:* Bison 3, Bison 5, Bison 7 & Bison 9



NEW MOISTURE ALARM ASSEMBLIES TO FIT DENTAL VACUUM UNITS!



RPI Part #VPA203
OEM Part #002854

MOISTURE ALARM ASSEMBLY

- Material: Urethane housing; 23-1/4" lg. cable
- Includes: Grommet (RPI Part #VPG205)

Fits: Vacuum Controller Enclosure

Models: DentalEZ/Custom Air/RamVac: Bulldog 550, Bulldog QT1, Bulldog QT2 & Bulldog QT3



RPI Part #VPA204
OEM Part #002855

MOISTURE ALARM ASSEMBLY

- Material: Urethane housing; 14-1/4" lg. cable
- Includes: Grommet (RPI Part #VPG205)

Fits: Vacuum Controller Enclosure

Models: DentalEZ/Custom Air/RamVac: Bison 3, Bison 5, Bison 7 & Bison 9

NEW PM KITS AND MORE TO FIT DENTAL VACUUM UNITS!

ADDRESS SERVICES REQUESTED

PERMIT NO. 2399
VAN NUYS, CA
U.S. POSTAGE PAID
PRESORTED STANDARD

replacement parts industries, inc.
625 Cochran Street • Simi Valley, California • 93065

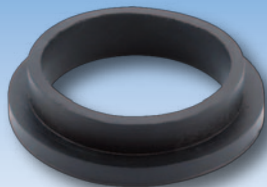

RPI Part #VPG195
OEM Part #000505

SPUD GASKET

- 2" round gasket
- Material: Black rubber
- Also available: Filter Kit (RPI Part #VPK113), Filter Kit (RPI Part #VPK117), Filter Element (RPI Part #VPE114), Filter Element (RPI Part #VPE115), and Filter Element (RPI Part #VPE118)

Fits: Vacuum Controller Assembly

Models: DentalEZ/Custom Air/RamVac: Bison 3, Bison 5, Bison 7, Bison 9, Bulldog 550, Bulldog QT1, Bulldog QT2 & Bulldog QT3



RPI Part #VPS191
OEM Part #30126601

VACUUM SWITCH





- 115/230VAC
- Contacts: N.C. DPST
- Factory set to: On @ 13"Hg. - Off @ 20"Hg.
- 1/4-18 NPSF Input Port - 3 Knock-outs for 1/2" NPT Conduit
- Also available: Pipe Sealant 567 (RPI Part #RPA459)



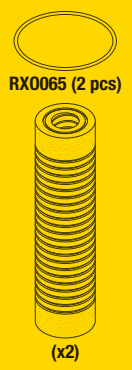

Fits: Vacuum Pump



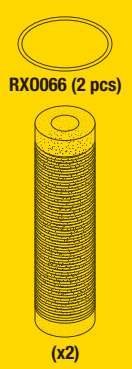

Models: Midmark: PM-1, PM-3 & PM-4;

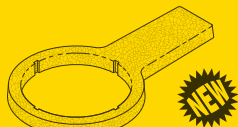
Matrx Medical • Matrx/Midmark: PM-75, PM-75-2 & PM-75-3

New Parts For Utility Room Water Control Systems!

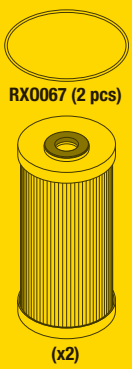
<p>RPI Part #WCE003 OEM Part #53035; PFM85240; 77000300; WFE-750</p> <p>FILTER ELEMENT (5 MICRON)</p> <ul style="list-style-type: none"> • 2 per package • Size: 2.50" OD x 9.88" lg. • Includes all parts as shown and PM Stickers • Recommended annual replacement for the Filter Element <p>Fits: 3/4" Filter Housing Assembly Models: See <i>Models</i> below</p>	<p></p> <p></p> <p>RX0065 (2 pcs)</p> <p>(x2)</p>	<p>RPI Part #RX0065 OEM Part #53106; MRP70950; 77007010</p> <p>O-RING</p> <ul style="list-style-type: none"> • 2 per package • Size: 3.859" ID x 4.137" OD x .139" C/S • Material: Nitrile (Buna-N), 70 Duro <p>Fits: 3/4" Filter Housing Assembly Models: See <i>Models</i> below</p>	<p></p> <p></p> <p>NOT SHOWN TO SIZE</p>	<p>RPI Part #WCT007 OEM Part #MMS71173; 7700069</p> <p>SPANNER WRENCH</p> <ul style="list-style-type: none"> • Wrench for 4.83" OD bowl <p>Fits: 4.83" ID Filter Housing Assembly Models: See <i>Models</i> below</p>	<p></p> <p></p>
<p>Models: Air Techniques: 53020 & 53020-1; Apollo/Midmark: ASAHWFB34, ASAHWFB34B, ASAHWFB34C, ASAWCFB34, ASAWCFB34B, ASAWCFB34C, ASAWFB34, ASAWFB34B & ASAWFB34C; Matrx Medical: FBR-34R; Midmark: 77002146; Tech West: WB-750, WB-750-RC, WBF-750 & WBF-750-RC</p>					

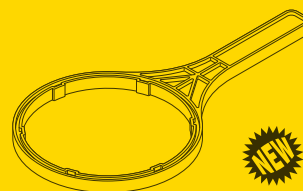
<p>RPI Part #WCE004 OEM Part #64520006</p> <p>FILTER ELEMENT (5 MICRON)</p> <ul style="list-style-type: none"> • 2 per package • Size: 2.50" OD x 9.88" lg. • Includes all parts as shown and PM Stickers • Recommended annual replacement for the Filter Element <p>Fits: 3/4" Filter Housing Assembly Models: See <i>Models</i> below</p>	<p></p> <p></p> <p>RX0066 (2 pcs)</p> <p>(x2)</p>	<p>RPI Part #RX0066 OEM Part # (No OEM Number Available)</p> <p>O-RING</p> <ul style="list-style-type: none"> • 2 per package • Size: 3.484" ID x 3.762" OD x .139" C/S • Material: Nitrile (Buna-N), 70 Duro <p>Fits: 3/4" Filter Housing Assembly Models: See <i>Models</i> below</p>	<p></p> <p></p> <p>NOT SHOWN TO SIZE</p>	<p>RPI Part #WCT008 OEM Part # (No OEM Number Available)</p> <p>SPANNER WRENCH</p> <ul style="list-style-type: none"> • Wrench for 3.86" OD bowl <p>Fits: 3.86" ID Filter Housing Assembly Models: See <i>Models</i> below</p>	<p></p> <p></p>
<p>Models: DentalEZ/Custom Air/Ramvac: WC110, WC210 & WC230</p>					

<p>RPI Part #WCE010 OEM Part # 53153; PFM85241; 77000473; 64520012; WPE-100</p> <p>FILTER ELEMENT (5 MICRON)</p> <ul style="list-style-type: none"> • 2 per package • Size: 4.50" OD x 9.75" lg. • Includes all parts as shown and PM Stickers • Recommended annual replacement for the Filter Element <p>Fits: 1", 1-1/4", and 1-1/2" Filter Housing Assembly Models: See <i>Models</i> below</p>	<p></p> <p></p> <p>RX0067 (2 pcs)</p> <p>(x2)</p>	<p>RPI Part #RX0067 OEM Part #53172-1; MRP70951; 65977200; 64553032</p> <p>O-RING</p> <ul style="list-style-type: none"> • 2 per package • Size: 5.510" ID x 5.850" OD x .170" C/S • Material: Nitrile (Buna-N), 70 Duro <p>Fits: 1", 1-1/4", and 1-1/2" Filter Housing Assembly Models: See <i>Models</i> below</p>	<p></p> <p></p> <p>NOT SHOWN TO SIZE</p>	<p>RPI Part #WCT012 OEM Part #77000063</p> <p>SPANNER WRENCH</p> <ul style="list-style-type: none"> • Wrench for 6.05" OD bowl <p>Fits: 6.05" ID Filter Housing Assembly Models: See <i>Models</i> below</p>	<p></p> <p></p>
<p>Models: Air Techniques: 53170 & 53171; Apollo/Midmark®: ASAWFB100, ASAWFB100B, ASAWFB100C, ASAWFB125, ASAWFB125C, ASAWFB150 & ASAWFB125C; DentalEZ: WC-300, WC-310, WC-400 & WC-410; Matrx Medical: FBP-100R, FBP-125R & FBP-150R; Midmark®: 77002147, 77002148 & 77002149; Tech West: WBF-100 & WBF-100-RC;</p>					



RPI Parts for ... Dental Utility Room Water Control Systems!

- Air Techniques
- Apollo/Midmark®
- DentalEZ/Custom Air/Ramvac
- Matrx/Midmark®
- Midmark®
- Tech West

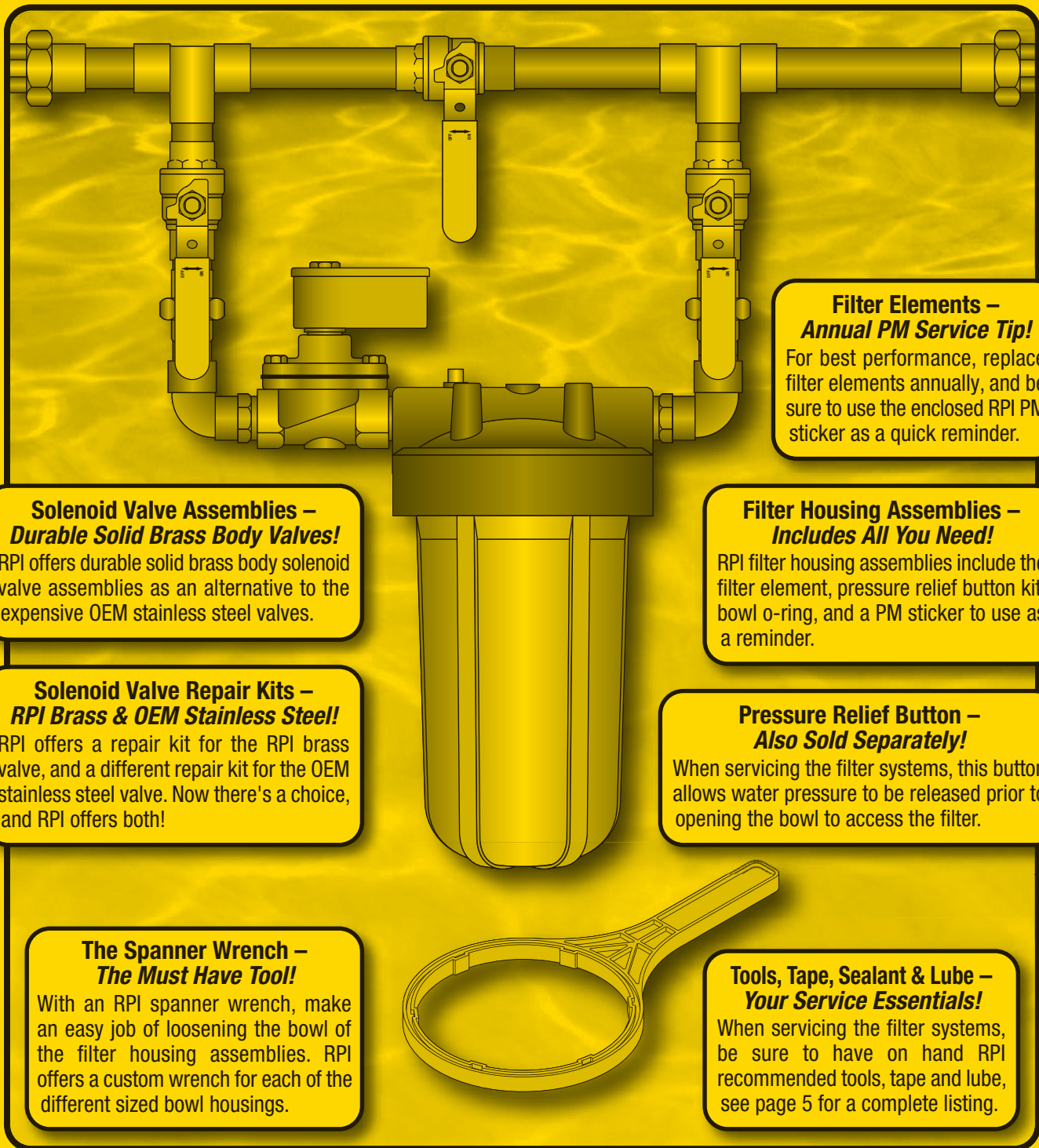

Solenoid Valve Assemblies – Durable Solid Brass Body Valves!
RPI offers durable solid brass body solenoid valve assemblies as an alternative to the expensive OEM stainless steel valves.

Solenoid Valve Repair Kits – RPI Brass & OEM Stainless Steel!
RPI offers a repair kit for the RPI brass valve, and a different repair kit for the OEM stainless steel valve. Now there's a choice, and RPI offers both!

The Spanner Wrench – The Must Have Tool!
With an RPI spanner wrench, make an easy job of loosening the bowl of the filter housing assemblies. RPI offers a custom wrench for each of the different sized bowl housings.

Filter Elements – Annual PM Service Tip!
For best performance, replace filter elements annually, and be sure to use the enclosed RPI PM sticker as a quick reminder.

Filter Housing Assemblies – Includes All You Need!
RPI filter housing assemblies include the filter element, pressure relief button kit, bowl o-ring, and a PM sticker to use as a reminder.

Pressure Relief Button – Also Sold Separately!
When servicing the filter systems, this button allows water pressure to be released prior to opening the bowl to access the filter.

Tools, Tape, Sealant & Lube – Your Service Essentials!
When servicing the filter systems, be sure to have on hand RPI recommended tools, tape and lube, see page 5 for a complete listing.



replacement parts industries, inc.

CALL (800) 221-9723 • FAX (818) 882-7028 • EMAIL order@rpiparts.com • WEBSITE www.rpiparts.com

The above parts are manufactured by Replacement Parts Industries, Inc. to fit the equipment noted. All product names used in this document are trademarks or registered trademarks of their respective holders. 1905WC SHOW 08/20



Models: Air Techniques: 53020 & 53020-1; Apollo/Midmark: ASAHWFB34, ASAHWFB34B, ASAHWFB34C, ASAWCFB34, ASAWCFB34B, ASAWCFB34C, ASAWFB34, ASAWFB34B & ASAWFB34C; Matrix/Midmark: FBR-34R; Midmark: 77002146; Tech West: WB-750, WB-750-RC, WBF-750 & WBF-750-RC

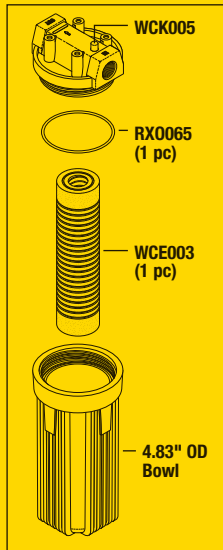

RPI Part #WCA001
OEM Part #53058;
53097; PFM70330;
7700077; WFB-750

FILTER HOUSING ASSEMBLY

- Ports: 3/4" FPT
 - 5 Micron Filtration
 - Includes all parts as shown and PM Sticker
 - Also available: Spanner Wrench (RPI Part #WCT007)
 - Recommended annual replacement for the Filter Element (5 Micron) (RPI Part #WCE003)
- Fits:** Water Control Systems

RPI Part #WCE003
OEM Part #53035; PFM85240;
77000300; WFE-750

FILTER ELEMENT (5 MICRON)

- 2 per package
 - Size: 2.50" OD x 9.88" lg.
 - Includes all parts as shown and PM Stickers
 - Recommended annual replacement for the Filter Element
- Fits:** 3/4" Filter Housing Assembly

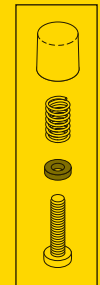

RPI Part #WCK005
OEM Part # (No OEM Number Available)

PRESSURE RELIEF BUTTON KIT

- Includes all parts as shown
- Fits:** Water Control Systems

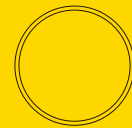

RPI Part #RX0066
OEM Part #53106;
MRP70950; 77007010

O-RING

- 2 per package
 - Size: 3.859" ID x 4.137" OD x .139" C/S
 - Material: Nitrile (Buna-N), 70 Duro
 - Included in: Filter Element (5 Micron) (RPI Part #WCE003)
- Fits:** 3/4" Filter Housing Assembly

NOT SHOWN TO SIZE

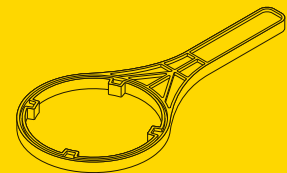

RPI Part #WCT007
OEM Part #MMS71173; 7700069

SPANNER WRENCH

- Wrench for 4.83" OD Bowl
- Fits:** 4.83" OD Filter Housing Assembly

Models: DentalEZ/Custom Air/Ramvac: WC110, WC210 & WC230

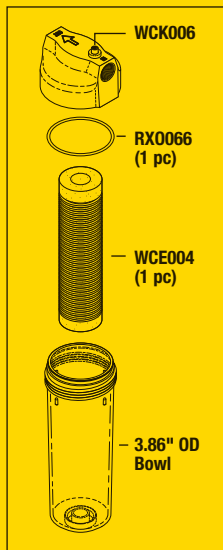

RPI Part #WCA002
OEM Part #64545021

FILTER HOUSING ASSEMBLY

- Ports: 3/4" FPT
 - 5 Micron Filtration
 - Includes all parts as shown and PM Sticker
 - Also available: Spanner Wrench (RPI Part #WCT008)
 - Recommended annual replacement for the Filter Element (5 Micron) (RPI Part #WCE004)
- Fits:** Water Control Systems

RPI Part #WCE004
OEM Part #64520006

FILTER ELEMENT (5 MICRON)

- 2 per package
 - Size: 2.50" OD x 9.88" lg.
 - Includes all parts as shown and PM Stickers
 - Recommended annual replacement for the Filter Element
- Fits:** 3/4" Filter Housing Assembly

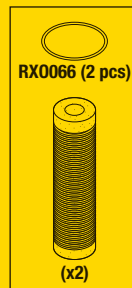

RPI Part #WCK006
OEM Part # (No OEM Number Available)

PRESSURE RELIEF BUTTON KIT

- Includes all parts as shown
- Fits:** Water Control Systems

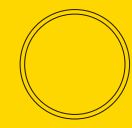

RPI Part #RX0066
OEM Part # (No OEM Number Available)

O-RING

- 2 per package
 - Size: 3.484" ID x 3.762" OD x .139" C/S
 - Material: Nitrile (Buna-N), 70 Duro
 - Included in: Filter Element (5 Micron) (RPI Part #WCE004)
- Fits:** 3/4" Filter Housing Assembly

NOT SHOWN TO SIZE

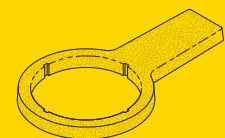

RPI Part #WCT008
OEM Part # (No OEM Number Available)

SPANNER WRENCH

- Wrench for 3.86" OD Bowl
- Fits:** 3.86" OD Filter Housing Assembly

Models: Air Techniques: 53170 & 53171; Apollo/Midmark: ASAWFB100, ASAWFB100B & ASAWFB100C; Matrix/Midmark: FBP-100R; Midmark: 77002147; Tech West: WBF-100 & WBF-100-RC

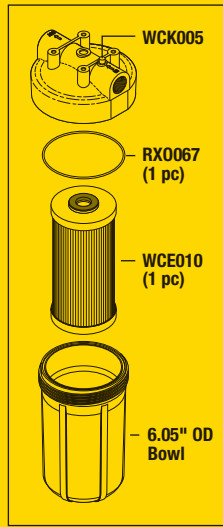

RPI Part #WCA009
OEM Part #53172;
77000073; 64545051;
WFB-1

FILTER HOUSING ASSEMBLY

- Ports: 1" FPT
 - 5 Micron Filtration
 - Includes all parts as shown and PM Sticker
 - Also available: Spanner Wrench (RPI Part #WCT012)
 - Recommended annual replacement for the Filter Element (5 Micron) (RPI Part #WCE010)
- Fits:** Water Control Systems

RPI Part #WCE010
OEM Part #53153;
PFM85241; 77000473;
64520012; WPE-100

FILTER ELEMENT (5 MICRON)

- 2 per package
 - Size: 4.50" OD x 9.75" lg.
 - Includes all parts as shown and PM Stickers
 - Recommended annual replacement for the Filter Element
- Fits:** 1", 1-1/4", and 1-1/2" Filter Housing Assy.

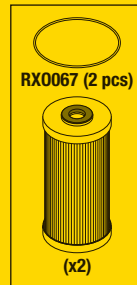

RPI Part #RX0067
OEM Part #53172-1;
MRP70951; 65977200;
64553032

O-RING

- 2 per package
 - Size: 5.510" ID x 5.850" OD x .170" C/S
 - Material: Nitrile (Buna-N), 70 Duro
 - Included in: Filter Element (5 Micron) (RPI Part #WCE010)
- Fits:** 1", 1-1/4", and 1-1/2" Filter Housing Assy.

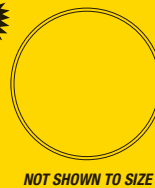

RPI Part #WCK005

OEM Part # (No OEM Number Available)

PRESSURE RELIEF BUTTON KIT

- Includes all parts as shown
- Fits:** Water Control Systems



RPI Part #WCT012

OEM Part #77000063

SPANNER WRENCH

- Wrench for 6.05" OD Bowl
- Fits:** 6.05" OD Filter Housing Assembly

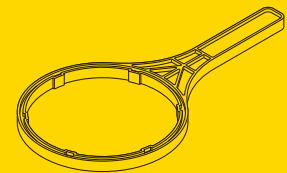

Models: Apollo/Midmark: ASAWFB150 & ASAWFB150C; Matrix/Midmark: FBP-150R; Midmark: 77002149

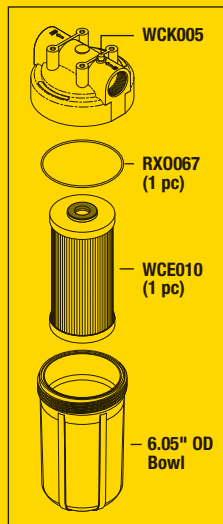

RPI Part #WCA014
OEM Part #7700073

FILTER HOUSING ASSEMBLY

- Ports: 1-1/2" FPT
 - 5 Micron Filtration
 - Includes all parts as shown and PM Sticker
 - Also available: Spanner Wrench (RPI Part #WCT012)
 - Recommended annual replacement for the Filter Element (5 Micron) (RPI Part #WCE010)
- Fits:** Water Control Systems

RPI Part #WCE010
OEM Part #53153;
PFM85241; 77000473;
64520012; WPE-100

FILTER ELEMENT (5 MICRON)

- 2 per package
 - Size: 4.50" OD x 9.75" lg.
 - Includes all parts as shown and PM Stickers
 - Recommended annual replacement for the Filter Element
- Fits:** 1", 1-1/4", and 1-1/2" Filter Housing Assy.

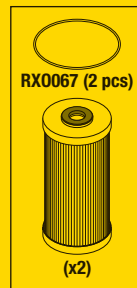

RPI Part #RX0067
OEM Part #53172-1;
MRP70951; 65977200;
64553032

O-RING

- 2 per package
 - Size: 5.510" ID x 5.850" OD x .170" C/S
 - Material: Nitrile (Buna-N), 70 Duro
 - Included in: Filter Element (5 Micron) (RPI Part #WCE010)
- Fits:** 1", 1-1/4", and 1-1/2" Filter Housing Assy.

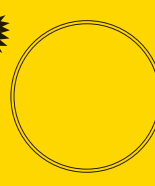

RPI Part #WCK005

OEM Part # (No OEM Number Available)

PRESSURE RELIEF BUTTON KIT

- Includes all parts as shown
- Fits:** Water Control Systems



RPI Part #WCT012

OEM Part #77000063

SPANNER WRENCH

- Wrench for 6.05" OD Bowl
- Fits:** 6.05" OD Filter Housing Assembly

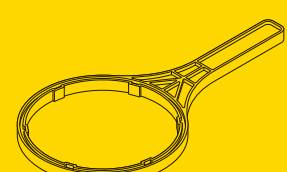

Models: Apollo/Midmark: ASAWFB125 & ASAWFB125C; DentalEZ/Custom Air/Ramvac: WC400 & WC410; Matrix/Midmark: FBP-125R; Midmark: 77002148

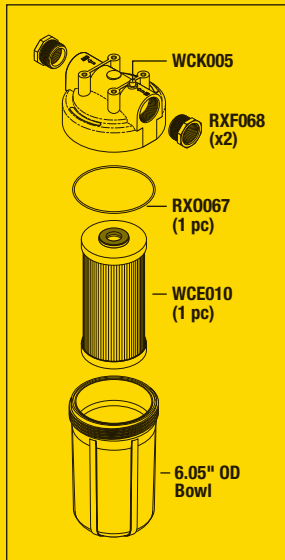

RPI Part #WCA013
OEM Part #7700073; 64622048; 64622102

FILTER HOUSING ASSEMBLY

- Ports: 1-1/4" FPT
 - 5 Micron Filtration
 - Includes all parts as shown and PM Sticker
 - Also available: Spanner Wrench (RPI Part #WCT012)
 - Recommended annual replacement for the Filter Element (5 Micron) (RPI Part #WCE010)
- Fits:** Water Control Systems



RPI Part #WCE010
OEM Part #53153; PFM85241; 77000473; 64520012; WPE-100

FILTER ELEMENT (5 MICRON)

- 2 per package
 - Size: 4.50" OD x 9.75" lg.
 - Includes all parts as shown and PM Stickers
 - Recommended annual replacement for the Filter Element
- Fits:** 1", 1-1/4", and 1-1/2" Filter Housing Assy.



RPI Part #WCK005
OEM Part # (No OEM Number Available)
PRESSURE RELIEF BUTTON KIT
 • Includes all parts as shown
Fits: Water Control Systems



RPI Part #RXF068
OEM Part # (No OEM Number Available)
ADAPTOR (1-1/2" MPT x 1-1/4" FPT)
 • Material: White PVC
Fits: 1-1/2" Filter Housing Assembly

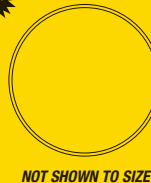

RPI Part #RX0067
OEM Part #53172-1; MRP70951; 65977200; 64553032

O-RING

- 2 per package
 - Size: 5.510" ID x 5.850" OD x .170" C/S
 - Material: Nitrile (Buna-N), 70 Duro
 - Included in: Filter Element (5 Micron) (RPI Part #WCE010)
- Fits:** 1", 1-1/4", and 1-1/2" Filter Housing Assy.

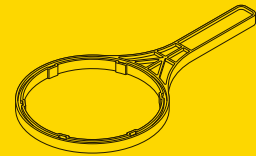

RPI Part #WCT012
OEM Part #7700063
SPANNER WRENCH
 • Wrench for 6.05" OD Bowl
Fits: 6.05" OD Filter Housing Assembly

Service Essentials - Tools, Tape, Sealant and Lube

RPI Part #RPA459
OEM Part # (No OEM Number Available)

PIPE SEALANT 567

- .20 fl. oz. (6ml) per unit
- Temperature range: -65°F to 400°F (-54° to 204°C)

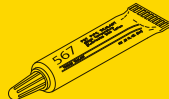

RPI Part #RPT579
OEM Part # (No OEM Number Available)

1/4" TEFLON THREAD SEALING TAPE

- 5 per package
- 1/4" x 260" per unit



RPI Part #RPL090
OEM Part # (No OEM Part # Available)

HIGH TEMP LUBRICANT

- 5 per package; 1/2 gram per unit
- Used on purge valves, pump packaging, gate valves, butterfly valves, sanitary valves, rubber and plastic o-rings, stems and pistons



RPI Part #RPT580
OEM Part # (No OEM Number Available)

1/2" TEFLON THREAD SEALING TAPE

- 5 per package
- 1/2" x 260" per unit



RPI Part #ILS014
OEM Part # (No OEM Part # Available)

SPANNER WRENCH

- Size: .525" ID x .875" HEX x .250" THK
- Replacement end attachment for Double Ended Spanner Wrench (RPI Part #RPT501) or use as a stand alone Spanner Nut



RPI Part #RPT501
OEM Part # (No OEM Part # Available)

DOUBLE ENDED SPANNER WRENCH

- Size: .875" HEX x 7" lg.
- Material: Aluminum handle with stainless steel end attachments
- Includes all parts as shown

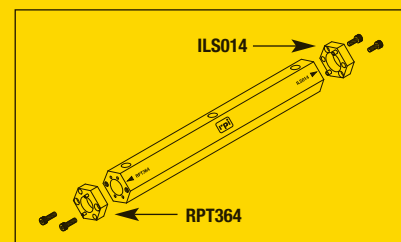



Brass Body

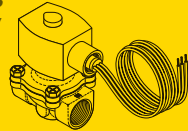

RPI Part #WCV018
OEM Part #53031 (Brass);
64622129 (SS)

SOLENOID VALVE

- 24VAC; Ports: 3/4" FPT
- Also available: Solenoid Valve Repair Kit (RPI Part #WCK020) for **brass** body solenoid valves. For OEM solenoid valves with **stainless steel** bodies, ask for the Solenoid Valve Repair Kit (RPI Part #WCK021).

Fits: Water Control Assembly

RPI BRASS VALVE REPAIR KIT

RPI Part #WCK020
OEM Part # (No OEM Number Available)

SOLENOID VALVE REPAIR KIT

- Includes all parts as shown
- **ONLY** Fits the **Brass Body** Solenoid Valve

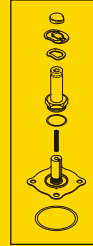

OEM S.S. VALVE REPAIR KIT

RPI Part #WCK021
OEM Part # (No OEM Number Available)

SOLENOID VALVE REPAIR KIT

- Includes all parts as shown plus a spanner nut
- **ONLY** Fits the DentalEZ **Stainless Steel** Body Valve #64622129

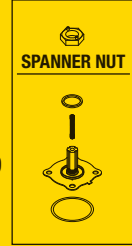

Brass Body

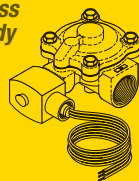

RPI Part #WCV026
OEM Part #53154 (Brass);
64622130 (SS)

SOLENOID VALVE

- 24VAC; Ports: 1" FPT
- Also available: Solenoid Valve Repair Kit (RPI Part #WCK028) for **brass** body solenoid valves. For OEM solenoid valves with **stainless steel** bodies, ask for the Solenoid Valve Repair Kit (RPI Part #WCK035).

Fits: Water Control Assembly

RPI BRASS VALVE REPAIR KIT

RPI Part #WCK028
OEM Part # (No OEM Number Available)

SOLENOID VALVE REPAIR KIT

- Includes all parts as shown
- **ONLY** Fits the **Brass Body** Solenoid Valve



OEM S.S. VALVE REPAIR KIT

RPI Part #WCK035
OEM Part # (No OEM Number Available)

SOLENOID VALVE REPAIR KIT

- Includes all parts as shown
- **ONLY** Fits the DentalEZ **Stainless Steel** Body Valve #64622130

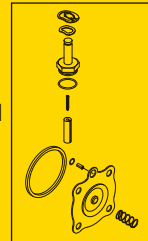

Brass Body

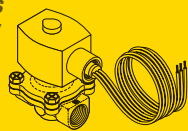

RPI Part #WCV015
OEM Part #64622128 (SS)

SOLENOID VALVE

- 24VAC; Ports: 1/2" FPT
- Also available: Solenoid Valve Repair Kit (RPI Part #WCK016) for **brass** body solenoid valves. For OEM solenoid valves with **stainless steel** bodies, ask for the Solenoid Valve Repair Kit (RPI Part #WCK011).

Fits: Water Control Assembly

RPI BRASS VALVE REPAIR KIT

RPI Part #WCK016
OEM Part # (No OEM Number Available)

SOLENOID VALVE REPAIR KIT

- Includes all parts as shown
- **ONLY** Fits the **Brass Body** Solenoid Valve

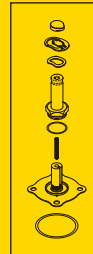

OEM S.S. VALVE REPAIR KIT

RPI Part #WCK011
OEM Part # (No OEM Number Available)

SOLENOID VALVE REPAIR KIT

- Includes all parts as shown plus a spanner nut
- **ONLY** Fits the DentalEZ **Stainless Steel** Body Valve #64622128

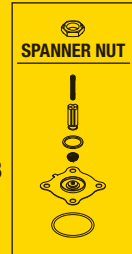

Brass Body

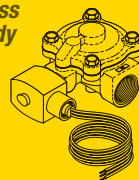

RPI Part #WCV029
OEM Part #53155 (Brass);
PVV10476 (Brass); 65976500 (SS)

SOLENOID VALVE

- 120VAC; Ports: 1" FPT
- Also available: Solenoid Valve Repair Kit (RPI Part #WCK028) for **brass** body solenoid valves. For OEM solenoid valves with **stainless steel** bodies, ask for the Solenoid Valve Repair Kit (RPI Part #WCK030).

Fits: Water Control Assembly

RPI BRASS VALVE REPAIR KIT

RPI Part #WCK028
OEM Part # (No OEM Number Available)

SOLENOID VALVE REPAIR KIT

- Includes all parts as shown
- **ONLY** Fits the **Brass Body** Solenoid Valve

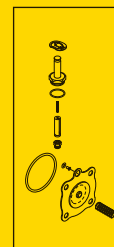

OEM S.S. VALVE REPAIR KIT

RPI Part #WCK030
OEM Part #77001648

SOLENOID VALVE REPAIR KIT

- Includes all parts as shown
- **ONLY** Fits the Midmark **Stainless Steel** body Valve #65976500

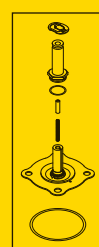



replacement parts industries, inc.

625 Cochran Street • Simi Valley, California • 93065

PRESORTED STANDARD
U.S. POSTAGE PAID
VAN NUYS, CA
PERMIT NO. 2399

ADDRESS SERVICES REQUESTED

Models: Matrx/Midmark: FBP-34R; Midmark: 77002146

RPI Part #WCV023
OEM Part #62970303 (SS)

SOLENOID VALVE

- 120VAC; Ports: 3/4" FPT
- Also available: Solenoid Valve Repair Kit (RPI Part #CSK050) for **brass** body solenoid valves. For OEM solenoid valves with **stainless steel** bodies, ask for the Solenoid Valve Repair Kit (RPI Part #WCK024).

Fits: Water Control Assembly

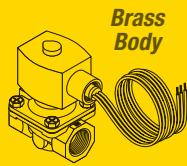

Brass Body

RPI BRASS VALVE REPAIR KIT

RPI Part #CSK050
OEM Part # (No OEM Number Available)

SOLENOID VALVE REPAIR KIT

- Includes all parts as shown
- **ONLY** Fits the **Brass Body** Solenoid Valve

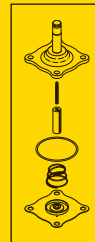

OEM S.S. VALVE REPAIR KIT

RPI Part #WCK024
OEM Part #77000997

SOLENOID VALVE REPAIR KIT

- Includes all parts as shown
- **ONLY** Fits the Midmark **Stainless Steel Body** Valve #62970303

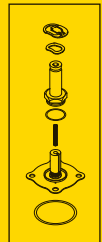

Models: Matrx/Midmark: 77002149 (Newer Matrx), 77000045 (Older Matrx); Midmark: 77002149

RPI Part #WCV032
OEM Part #65910800 (SS)

SOLENOID VALVE

- 120vac; Ports: 1-1/2" FPT
- Also available: Solenoid Valve Repair Kit (RPI Part #WCK033) for **brass** body solenoid valves. For OEM solenoid valves with **stainless steel** bodies, ask for the Solenoid Valve Repair Kit (RPI Part #WCK034).

Fits: Water Control Assembly

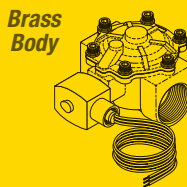

Brass Body

RPI BRASS VALVE REPAIR KIT

RPI Part #WCK033
OEM Part # (No OEM Number Available)

SOLENOID VALVE REPAIR KIT

- Includes all parts as shown
- **ONLY** For the **Brass Body** Solenoid Valve

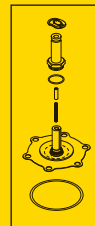

OEM S.S. VALVE REPAIR KIT

RPI Part #WCK034
OEM Part #77000967

SOLENOID VALVE REPAIR KIT

- Includes all parts as shown
- **ONLY** Fits the Midmark **Stainless Steel Body** Valve #65910800

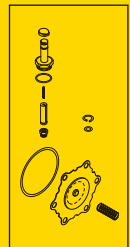

Models: Air Techniques: 53020-1 & 53021-1



Brass Body

RPI Part #WCV022
OEM Part #53031-1 (Brass)

SOLENOID VALVE

- 120VAC; Ports: 3/4" FPT
- Fits:** Water Control Assembly

REPAIR KIT

RPI Part #WCK020
OEM Part # (No OEM Number Available)

SOLENOID VALVE REPAIR KIT

- Includes all parts as shown
- Fits:** Solenoid Valve

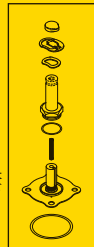

Models: Tech West: WB-100-RC & WBF-100-RC



Brass Body

RPI Part #WCV025
OEM Part #WMV-100

SOLENOID VALVE

- 120VAC; Ports: 1" FPT
- Fits:** Water Control Assembly

REPAIR KIT

RPI Part #WCK027
OEM Part # (No OEM Number Available)

SOLENOID VALVE REPAIR KIT

- Includes all parts as shown
- Fits:** Solenoid Valve



Models: Midmark: 77002148



Brass Body

RPI Part #WCV031
OEM Part #65976900 (Brass)

SOLENOID VALVE

- 120VAC; Ports: 1-1/4" FPT
- Fits:** Water Control Assembly

REPAIR KIT

RPI Part #WCK028
OEM Part # (No OEM Number Available)

SOLENOID VALVE REPAIR KIT

- Includes all parts as shown
- Fits:** Solenoid Valve

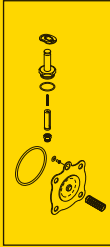

Models: Tech West: WB-750-RC & WBF-750-RC



Brass Body

RPI Part #WCV017
OEM Part #WMV-750

SOLENOID VALVE

- 120VAC; Ports: 3/4" FPT
- Fits:** Water Control Assembly

REPAIR KIT

RPI Part #WCK019
OEM Part # (No OEM Number Available)

SOLENOID VALVE REPAIR KIT

- Includes all parts as shown
- Fits:** Solenoid Valve

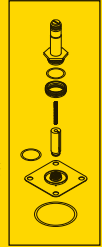

RPI Parts for Dental Utility Room Water Control Systems!

Models these RPI Parts fit							
RPI PART #	DESCRIPTION	AIR TECHNIQUES	APOLLO/ MIDMARK®	DENTAL EZ®/ CUSTOM AIR/RAMVAC	MATRIX/MIDMARK®	MIDMARK®	TECH WEST
FILTER ELEMENTS							
WCE003	FILTER ELEMENT (5 MICRON)	53020 & 53020-1	ASAHWF34, ASAHWF34B, ASAHWF34C, ASAWCFB34, ASAWCFB34B, ASAWCFB34C, ASAWFB34, ASAWFB34B & ASAWFB34C		FBR-34R	77002146	WBF-750 & WBF-750-RC
WCE004	FILTER ELEMENT (5 MICRON)			WC110, WC210 & WC230			
WCE010	FILTER ELEMENT (5 MICRON)	53170 & 53171	ASAWFB100, ASAWFB100B, ASAWFB100C, ASAWFB125, ASAWFB125C, ASAWFB150 & ASAWFB150C	WC300, WC310, WC400 & WC410	FBP-100R, FBP-125R & FBP-150R	77002147, 77002148 & 77002149	WBF-100 & WBF-100-RC
FILTER HOUSING ASSEMBLIES							
WCA001	FILTER HOUSING ASSEMBLY	53020 & 53020-1	ASAHWF34, ASAHWF34B, ASAHWF34C, ASAWCFB34, ASAWCFB34B, ASAWCFB34C, ASAWFB34, ASAWFB34B & ASAWFB34C		FBR-34R	77002146	WBF-750 & WBF-750-RC
WCA002	FILTER HOUSING ASSEMBLY			WC110, WC210 & WC230			
WCA009	FILTER HOUSING ASSEMBLY	53170 & 53171	ASAWFB100, ASAWFB100B & ASAWFB100C		FBP-100R	77002147	WBF-100, WBF-100-RC
WCA013	FILTER HOUSING ASSEMBLY		ASAWFB125 & ASAWFB125C	WC400 & WC410	FBP-125R	77002148	
WCA014	FILTER HOUSING ASSEMBLY		ASAWFB150 & ASAWFB150C		FBP-150R	77002149	
O-RINGS							
RX0065	O-RING	53020 & 53020-1	ASAHWF34, ASAHWF34B, ASAHWF34C, ASAWCFB34, ASAWCFB34B, ASAWCFB34C, ASAWFB34, ASAWFB34B & ASAWFB34C		FBR-34R	77002146	WB-750, WB-750-RC, WBF-750 & WBF-750-RC
RX0066	O-RING			WC110, WC210 & WC230			
RX0067	O-RING	53170 & 53171	ASAWFB100, ASAWFB100B, ASAWFB100C, ASAWFB125, ASAWFB125C, ASAWFB150 & ASAWFB150C	WC300, WC310, WC400 & WC410	FBP-100R, FBP-125R & FBP-150R	77002147, 77002148 & 77002149	WBF-100 & WBF-100-RC
PRESSURE RELIEF BUTTON KITS							
WCK005	PRESSURE RELIEF BUTTON KIT	3/4" & 1" Water Control Systems	ASAHWF34, ASAHWF34B, ASAHWF34C, ASAWCFB34, ASAWCFB34B, ASAWCFB34C, ASAWFB34, ASAWFB34B, ASAWFB34C, ASAWFB100, ASAWFB100B, ASAWFB100C, ASAWFB125, ASAWFB125C, ASAWFB150 & ASAWFB150C	WC400 & WC410	3/4", 1", 1-1/4" & 1-1/2" Water Control Systems	3/4", 1", 1-1/4" & 1-1/2" Water Control Systems	WBF-750, WBF-750-RC, WBF-100 & WBF-100-RC
WCK006	PRESSURE RELIEF BUTTON KIT			WC110, WC210 & WC230			
SOLENOID VALVES							
WCV015	SOLENOID VALVE			WC110			
WCV017	SOLENOID VALVE						WB-750-RC & WBF-750-RC
WCV018	SOLENOID VALVE	53020 & 53021		WC210 & WC230			
WCV022	SOLENOID VALVE	53020-1 & 53021-1					
WCV023	SOLENOID VALVE				FBR-34R	77002146	
WCV025	SOLENOID VALVE						WB-100-RC & WBF-100-RC
WCV026	SOLENOID VALVE	53170 & 53173		WC300			
WCV029	SOLENOID VALVE	53171 & 53174	ASAWB100, ASAWFB100		FBP-100R	77002147	
WCV031	SOLENOID VALVE					77002148	
WCV032	SOLENOID VALVE				77002149 (Newer Matrix) & 77000045 (Older Matrix)	77002149	
SOLENOID VALVE REPAIR KITS							
CSK050	SOLENOID VALVE REPAIR KIT				FBR-34R	77002146	
WCK011	SOLENOID VALVE REPAIR KIT			WC110			
WCK016	SOLENOID VALVE REPAIR KIT			WC110			
WCK019	SOLENOID VALVE REPAIR KIT						WB-750-RC & WBF-750-RC
WCK020	SOLENOID VALVE REPAIR KIT	53020, 53021, 53020-1 & 53021-1		WC210 & WC230			
WCK021	SOLENOID VALVE REPAIR KIT			WC210 & WC230			
WCK024	SOLENOID VALVE REPAIR KIT					77002146	
WCK027	SOLENOID VALVE REPAIR KIT						WB-100-RC & WBF-100-RC
WCK028	SOLENOID VALVE REPAIR KIT	53170, 53171, 53173 & 53174	ASAWB100, ASAWFB100	WC300	FBP-100R	77002147 & 77002148	
WCK030	SOLENOID VALVE REPAIR KIT					77002147	
WCK033	SOLENOID VALVE REPAIR KIT				77002149 (Newer Matrix) & 77000045 (Older Matrix)	77002149	
WCK034	SOLENOID VALVE REPAIR KIT				FBP-150R	77002149	
WCK035	SOLENOID VALVE REPAIR KIT			WC300			
SPANNER WRENCHES							
ILS014	SPANNER WRENCH	53020, 53020-1, 53021, 53021-1, 53170, 53171, 53173 & 53174	ASAWB34, ASAWB34C, ASAWB100, ASAWB100C, ASAWB125, ASAWB125C, ASAWB150, ASAWB150C, ASAWCFB34, ASAWCFB34C, ASAWFB34, ASAWFB34C, ASAWFB100, ASAWFB100C, ASAWFB125, ASAWFB125C, ASAWFB150, ASAWFB150C, ASAHWF34 & ASAHWF34C	WC110, WC210, WC230 & WC300	FBP-12R, FBP-34R, FBP-100R, FBP-125R & FBP-150R	77002146, 77002147, 77002148 & 77002149	WB-100, WB-100-RC, WB-750, WB-750-RC, WBF-100, WBF-100-RC, WBF-750 & WBF-750-RC
RPT501	DOUBLE ENDED SPANNER WRENCH	53020, 53020-1, 53021, 53021-1, 53170, 53171, 53173 & 53174	ASAWB34, ASAWB34C, ASAWB100, ASAWB100C, ASAWB125, ASAWB125C, ASAWB150, ASAWB150C, ASAWCFB34, ASAWCFB34C, ASAWFB34, ASAWFB34C, ASAWFB100, ASAWFB100C, ASAWFB125, ASAWFB125C, ASAWFB150, ASAWFB150C, ASAHWF34 & ASAHWF34C	WC110, WC210, WC230 & WC300	FBP-12R, FBP-34R, FBP-100R, FBP-125R & FBP-150R	77002146, 77002147, 77002148 & 77002149	WB-100, WB-100-RC, WB-750, WB-750-RC, WBF-100, WBF-100-RC, WBF-750 & WBF-750-RC
WCT007	SPANNER WRENCH	53020 & 53020-1	ASAHWF34, ASAHWF34B, ASAHWF34C, ASAWCFB34, ASAWCFB34B, ASAWCFB34C, ASAWFB34, ASAWFB34B & ASAWFB34C		FBR-34R	77002146	WB-750, WB-750-RC, WBF-750 & WBF-750-RC
WCT008	SPANNER WRENCH			WC110, WC210 & WC230			
WCT012	SPANNER WRENCH	53170 & 53171	ASAWFB100, ASAWFB100B, ASAWFB100C, ASAWFB125, ASAWFB125C, ASAWFB150 & ASAWFB150C	WC300, WC310, WC400 & WC410	FBP-100R, FBP-125R & FBP-150R	77002147, 77002148 & 77002149	WBF-100 & WBF-100-RC
ACCESSORIES							
RPA459	PIPE SEALANT 567	53020, 53020-1, 53021, 53170, 53171, 53173 & 53174	ASAWB100, ASAHWF34, ASAHWF34B, ASAHWF34C, ASAWCFB34, ASAWCFB34B, ASAWCFB34C, ASAWFB34, ASAWFB34B, ASAWFB34C, ASAWFB100, ASAWFB100C, ASAWFB125, ASAWFB125C, ASAWFB150 & ASAWFB150C	WC110, WC210, WC230, WC300, WC400 & WC410	FBR-34R, FBP-100R, FBP-125R, FBP-150R, 77002149 (Newer Matrix) & 77000045 (Older Matrix)	77002146, 77002147, 77002148 & 77002149	WB-100-RC, WBF-100-RC, WBF-750 & WBF-750-RC
RPL090	HIGH TEMP LUBRICANT	53020, 53020-1, 53021, 53170, 53171, 53173 & 53174	ASAWB34, ASAWB34C, ASAWB100, ASAWB100C, ASAWB125, ASAWB125C, ASAWB150, ASAWB150C, ASAWCFB34, ASAWCFB34C, ASAWFB34, ASAWFB34B, ASAWFB34C, ASAWFB100, ASAWFB100C, ASAWFB125, ASAWFB125C, ASAWFB150, ASAWFB150C, ASAHWF34 & ASAHWF34C	WC110, WC210, WC230 & WC300	FBP-12R, FBP-34R, FBP-100R, FBP-125R & FBP-150R		WB-100, WB-100-RC, WB-750, WB-750-RC, WBF-100, WBF-100-RC, WBF-750 & WBF-750-RC
RPT579	1/4" TEFLON THREAD SEALING TAPE	53020, 53020-1, 53021, 53170, 53171, 53173 & 53174	ASAWB100, ASAHWF34, ASAHWF34B, ASAHWF34C, ASAWCFB34, ASAWCFB34B, ASAWCFB34C, ASAWFB34, ASAWFB34B, ASAWFB34C, ASAWFB100, ASAWFB100B, ASAWFB100C, ASAWFB125, ASAWFB125C, ASAWFB150 & ASAWFB150C	WC110, WC210, WC230, WC300, WC400 & WC410	FBR-34R, FBP-100R, FBP-125R, FBP-150R, 77002149 (Newer Matrix) & 77000045 (Older Matrix)	77002146, 77002147, 77002148 & 77002149	WB-100-RC, WBF-100-RC, WBF-750 & WBF-750-RC
RPT580	1/2" TEFLON THREAD SEALING TAPE	53020, 53020-1, 53021, 53170, 53171, 53173 & 53174	ASAWB100, ASAHWF34, ASAHWF34B, ASAHWF34C, ASAWCFB34, ASAWCFB34B, ASAWCFB34C, ASAWFB34, ASAWFB34B, ASAWFB34C, ASAWFB100, ASAWFB100B, ASAWFB100C, ASAWFB125, ASAWFB125C, ASAWFB150 & ASAWFB150C	WC110, WC210, WC230, WC300, WC400 & WC410	FBR-34R, FBP-100R, FBP-125R, FBP-150R, 77002149 (Newer Matrix) & 77000045 (Older Matrix)	77002146, 77002147, 77002148 & 77002149	WB-100-RC, WBF-100-RC, WBF-750 & WBF-750-RC
RXF068	ADAPTOR (1-1/2" MPT x 1-1/4" FPT)		ASAWFB125 & ASAWFB125C	WC400 & WC410	FBP-125R	77002148	



Proud to be a Healthcare Components Group brand ...



HEALTHCARE
Components Group

DENTAL WATER CONTROLS -

Air Techniques, Apollo/Midmark, DentaleEZ/
Custom Air/Ramvac, Matrx/Midmark,
Midmark, & Tech West

New
Parts
to fit

Dental Utility Room Water Control Systems!



RPI Part #WCP036
OEM Part #64637011

POWER SUPPLY

- 24VAC/50VA Class 2 plug-in with thermal cut-out
- Includes: Case with mounting tab and screw terminals

Fits: Wall Power Plug

Models: DentaleZ/Custom Air/Ramvac: WC110, WC210, WC230 & WC300



RPI Part #WCP037
OEM Part #77000067; 77000068

LOW VOLTAGE CONTROL RELAY

- Provides switching for high current loads
- Coil: 24VAC
- DPST; contacts rated 100VA @ 120VAC, 50VA @ 240VAC

Fits: Low Voltage Control Assembly

Models: Matrx Medical • Matrx/Midmark: FBP-12R, FBP-34R, FBP-100R, FBP-125R, FBP-150R, 77000041, 77000042, 77000043, 77000044 & 77000045
Midmark®: 77002146, 77002147, 77002148 & 77002149



RPI Part #RXC041
OEM Part #EC-115

HOSPITAL GRADE POWER CORD (15A @ 125VAC, 10 ft.)

- Length: 10 ft. with jacket stripped 8"; Color: Gray
- 12/3 SJT, 105°C; 15A @ 125VAC
- Plug: NEMA 5-15P; Connector: None .453" O.D. cord
- Includes: (3 ea) #6 spade terminals

Fits: Relay Control 24V 115V

Models: Tech West: WB-100-RC, WB-750-RC, WBF-100-RC & WBF-750-RC

RPI Part #VPT146
OEM Part #PT-100

TRANSFORMER

- Primary: Dual 120VAC; 60Hz.
- Secondary: 24VAC @ 25A

Fits: Electrical Control Box/Relay Control 24V/115-230V

Models: Tech West: WB-100-RC, WB-750-RC, WBF-100-RC & WBF-750-RC



RPI Part #VPR148
OEM Part #55857 & 55407

RELAY (ELECTRICAL CONTACTOR)

- Coil: 24VAC, 11 ohms
- 2 pole, contacts rated at 30A; 1/4" Tabs

Fits: Vacuum Electrical Control Box/Relay Control 24V/115-230V

Models: Tech West: WB-100-RC, WB-750-RC, WBF-100-RC & WBF-750-RC

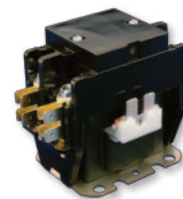

RPI Part #CAS042
OEM Part #TS-100

ON/OFF SWITCH ASSEMBLY

- Toggle switch (On-Off)
- 3A @ 250VAC; SPST
- 6" lg. #18 AWG wires
- Panel cutout: 1/2" dia.
- Includes: On-Off legend plate, mounting hardware, and (1 pc) Flag Terminal (1/4" QC) (RPI Part #RPT905)

Fits: Control Panel

Models: Tech West: WB-100-RC, WB-750-RC, WBF-100-RC & WBF-750-RC



RPI Part #RPH988
OEM Part #FH-100

FUSE HOLDER

- Accommodates 1/4" x 1-1/4" fuse; 20A @ 250VAC
- 3/16" Tabs
- Mounting hole size: .500" dia.
- Includes mounting hardware
- Also available for Tech West Vacuums: Fuse (1/4A, 250V) (RPI Part #RPF059)

Fits: Electrical Control Box/Relay Control 24V/115-230V

Models: Tech West: WB-100-RC, WB-750-RC, WBF-100-RC & WBF-750-RC



replacement parts industries, inc.

Add this page to your RPI catalog – Section 4, Page 1902

CALL (800) 221-9723 • FAX (818) 882-7028 • EMAIL order@ripiparts.com • WEBSITE www.rpiparts.com

The above parts are manufactured by Replacement Parts Industries, Inc. to fit the equipment noted. All product names used in this document are trademarks or registered trademarks of their respective holders. Web 08/22

SECTION

4

PAGE

1902

UPDATED

08/22

New Parts to fit Dental Utility Room Water Control Systems!

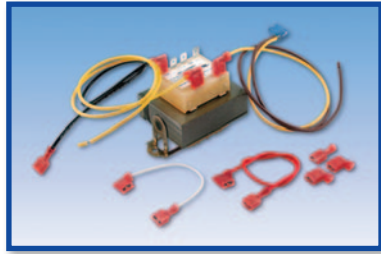

RPI Part #VPT142

OEM Part #54623, 54375, 55866, 55867, 56325, 85934, 86637, 85275 & 85362

TRANSFORMER

- Primary: 120/208/240VAC; 50/60Hz.
- Secondary: 24VAC @ 40A
- Size: 2-5/8" L x 2-3/16" W x 2-3/16" H; 1/4" Tabs
- Includes all parts as shown

Fits: Electrical Control Box/Relay Control 24V/115-230V

Models: Air Techniques: 53170, 53171, 53020, 53020-1, 53173, 53174, 53021 & 53021-1



RPI Part #VPB182

OEM Part #117061

CIRCUIT BREAKER (1/2A)

- 1/2 Amp @ 250VAC
- 1/4" Tabs
- Panel cutout: 5/8" dia.
- Push to reset

Fits: Electrical Control Box/24 Volt Water System Transformers

Models: Air Techniques: 53170, 53171, 53020, 53020-1, 53173, 53174, 53021 & 53021-1



RPI Part #RPC554

OEM Part # (No OEM Part # Available)

HOSPITAL GRADE POWER CORD (15A @ 125VAC, 8 ft.)

- Length: 8 ft.; Color: Gray
- 14/3 SJT, 105°C; 15A @ 125VAC
- Plug: NEMA 5-15P
- Connector Type: EN60320-C13

Fits: 24 Volt Water System Transformers

Models: Air Techniques: 53170, 53171, 53020, 53020-1, 53173, 53174, 53021 & 53021-1



RPI Part #RPR583

OEM Part # (No OEM Part # Available)

AC INLET RECEPTACLE

- C13 style connector; 1/4" Tabs
- 15A @ 250VAC
- Fits panel cut-out: .787" x 1.083" (20mm x 27.5mm);
Mounting Holes: .134" dia. (3.4mm) @ 1.575" (40mm) centers

Fits: Panel/24 Volt Water System Transformers

Models: Air Techniques: 53170, 53171, 53020, 53020-1, 53173, 53174, 53021 & 53021-1



replacement parts industries, inc. A Healthcare Components Group Company

CALL (800) 221-9723 • FAX (818) 882-7028 • EMAIL order@rpiparts.com • WEBSITE www.rpiparts.com