

OEM MODEL Section 5 Page #'s

## ECG/EKG & EEG

### BURDICK

Atria 3000	203
DC-175	201
DC-180	201
DC-185	200-201
DC-190	200
DC-195	201
E100	200
E200	200
E310	200
E320	200
E350 & E350I	202-203
E500 TW	200
E550	202-203
E560	202-203
E600	200
Eclipse	202-203
Eclipse 4	203
Eclipse 400	203
Eclipse 8	203
Eclipse 800	203
Eclipse 850	203
Eclipse LE	202-203
Eclipse LEI	202-203
Eclipse LEII	203
Eclipse Plus	203
EK-1	201-203
EK-2	201-203
EK-3	201-203
EK-4	201-203
EK-5	200-203
EK-5A	200-203
EK-6	200
EK-7	200
EK-8	200-201
EK-10	201-203
EK-670	200
Elite	202-203
Elite II	202-203
MC-600	200
Medic 3	202
Medic 4	202
Medic 5	202
MW200	201
MW225	201
PA-100	201
PA-101	201
PA-104	201
PA-107	201
Sirecust 630	202
Sirecust DU	202
TMS-302	200
UT420	201
UT4300	201

OEM MODEL Section 5 Page #'s

## ESU

### COVIDIEN/VALLEYLAB

Force 1C	600 & 602
Force 2-2	600-603
Force 2-8	600, 602 & 603
Force 4	600, 602 & 603
Force 30	600, 602 & 603
Force 40	600, 602 & 603
Force EZ	600, 602 & 603
Force EZ-8	600, 602 & 603
Force EZ-8C	600, 602 & 603
Force EZ-C	600, 602 & 603
Force FX	600-603
Force FX-8	600-603
Force FX-8C	600-603
Force FX-C	600-603
Force Triad	600 & 602

## NON-INVASIVE BLOOD PRESSURE MONITORS

### GE/CRITIKON

Dinamap™ 8100	300-301
Dinamap™ 8100T	300-301
Dinamap™ 8110	301
Dinamap™ 8120	301
Dinamap™ 9300	300-301
Dinamap™ 9340	300-301
Dinamap™ 9350	301
Dinamap™ 9400	301
Dinamap™ 9500XL	301

## PATIENT, HOLTER & TELEMETRY CABLES

### PATIENT, HOLTER & TELEMETRY CABLES

Accessories	402 & 417
Cables to fit GE Acquisition Modules	405
Din/Unshielded	402-403
Dual/Shielded	404-405
Dual/Shielded to fit GE Multi-Link®	405
Fixed	400-401
Holter Cables	406
Telemetry Cables	406-407

(continued)

## PATIENT & HOLTER CABLE LEADWIRES

### LEADWIRES & LEADWIRE SETS

Accessories .....	402 & 417
Bonded Leadwire Sets to fit GE Multi-Link® .....	408
Combined Leadwire Sets to fit GE Multi-Link® ...	409
Din/Unshielded Disposable Leadwire Sets ..	415-416
Din/Unshielded Individual Leadwires .....	412
Din/Unshielded Leadwire Sets .....	411-412
Dual/Shielded Disposable Leadwire Sets ....	416-417
Dual/Shielded Individual Leadwires .....	414
Dual/Shielded Leadwire Sets .....	413
Leadwire Sets to fit GE Multi-Link® .....	410
Veterinary Din/Unshielded Individual Leadwires .	419
Veterinary Din/Unshielded Leadwire Sets .....	418
Veterinary Dual/Shielded Individual Leadwires ..	419
Veterinary Dual/Shielded Leadwire Sets .....	418-419

## WELCH ALLYN WALL TRANSFORMERS

### WELCH ALLYN WALL TRANSFORMERS

767 .....	500-501
11600 Ophthalmoscope .....	501
11605 Ophthalmoscope .....	501
11610 Ophthalmoscope .....	501
11710 Ophthalmoscope .....	501
11800 Ophthalmoscope .....	501
11810 Ophthalmoscope .....	501
11820 Ophthalmoscope .....	501
12400 Strabismoscope .....	501
18000 Retinoscope .....	501
20000 Otoscope .....	501
20200 Otoscope .....	501
20202 Otoscope .....	501
21700 Otoscope .....	501
23810 Otoscope .....	501
23820 Otoscope .....	501
25000 Otoscope .....	501
25020 Otoscope .....	501
25200 Otoscope .....	501
26530 Illuminator .....	501
27000 Illuminator .....	501
27050 Illuminator .....	501
28100 Tongue Blade Holder .....	501
43700 Episcopes .....	501
43300 Illuminator .....	501
43700 Episcopes .....	501
73500 Handler Adapter .....	501
74710 .....	500-501

# Patient, Holter & Telemetry Cables

PATIENT CABLE TYPE Found on Page #'s	FIXED 400-401	DIN/ UNSHIELDED 402-403	DUAL/ SHIELDED 404-405
<b>PATIENT, HOLTER &amp; TELEMETRY CABLES</b>			
<b>ABBOTT</b> AAEMM, AAXM, ABBV, ABBY SERIES, ABEM, ABTM & EX-50 • Leadwire sets also available, see pages 408-419.		KCA004	KEC010
<b>ABBOTT</b> EKR50 & EXPI • Leadwire sets also available, see pages 408-419.			KEC010
<b>ABBOTT</b> LIFECARE 5100 & 5200 • Leadwire sets also available, see pages 408-419.	KCB008 <sup>1</sup> KEB012 <sup>2</sup>	KCA007	KCC009
<b>ACCUCORE/PIC/VITALCOM</b> TELEMETRY SYSTEM 3 LEAD ^KCB028 (Telemetry cable), see page 406.	KCB028^		
<b>ACCUCORE/PIC/VITALCOM</b> TELEMETRY SYSTEM 4 LEAD ^KDB002 (Telemetry cable), see page 407.	KDB002^		
<b>ACCUCORE/PIC/VITALCOM</b> TELEMETRY SYSTEM 5 LEAD ^KEB015 (Telemetry cable), see page 407.	KEB015^		
<b>ADVANCED TECH LABS</b> SEE ATL			
<b>AGILENT</b> SEE HEWLETT PACKARD/AGILENT/ZYMED/PHILIPS MEDICAL			
<b>A.I.R.</b> 3000 HOLTER (3 Channel 7 LEAD) ^ KGA001 (Holter cable), see page 406. • Leadwire sets also available, see pages 408-419.		KGA001^	
<b>AIR SHIELDS/HILL ROM/VICKER/NARCO</b> HRRM-71, HRRM-72, PORTAFIB I, PORTAFIB II, & SYSTEM 6 NEONATAL • Leadwire sets also available, see pages 408-419.	KCB002	KCA001	KCC003
<b>AIR SHIELDS/HILL ROM/VICKER/NARCO</b> PORTAFIB III & SYSTEM 5 NEW • Leadwire sets also available, see pages 408-419.	KCB002	KCA001	KCC003 <sup>1</sup> KEC010 <sup>2</sup>
<b>AMERICAN OPTICAL</b> 1125, 1700 & PULSAR 4 • Leadwire sets also available, see pages 408-419.	KCB002	KCA001	KCC003
<b>AMERICAN OPTICAL</b> 5260, 5330, 26125 & 33167 • Leadwire sets also available, see pages 408-419.	KCB002	KCA001	
<b>ATL</b> 400; 800; 800 PLUS; VERA MARK; and ULTRAMARK 4, 4 PLUS, 5, 7 & 9 • Leadwire sets also available, see pages 408-419.	KCB002	KCA001	KCC003
<b>BECTON DICKINSON</b> SEE ELECTRODYNE/BECTON DICKINSON/DATAMEDIX/PPG			
<b>BIOCHEM INT'L</b> 3101, 3404, 6100, 9100, ADVISOR & AUTOCORR • Leadwire sets also available, see pages 408-419.	KCB002	KCA001	KCC003
<b>BIONET</b> CARDIOCARE 2000 & CARDIOTOUCH 3000	KKB002		
<b>BIRTCHEER</b> 300, 335 & 337	KEB014 <sup>3</sup>		
<b>BIRTCHEER</b> 365 CARDIOTRACER, 375 CARDIOTRACER & 375-11	KKB002		
<b>BRAEMER</b> DL125 & DL1700 ^ KGA001 (Holter cable), see page 406. • Leadwire sets also available, see pages 408-419.		KGA001^	
<b>BURDICK/SIEMENS</b> ATRIA 3000; ECLIPSE 4, 8, 400, 800, 850, 850 PLUS; ECLIPSE LE II; PLUS	KKB008		
<b>BURDICK/SIEMENS</b> EK-1, EK-2, EK-3, EK-4, EK-5 & EK-5A	KEB014 <sup>3</sup>		

<sup>1</sup> 3 Leadwire Patient Cable      <sup>2</sup> 5 Leadwire Patient Cable      <sup>3</sup> Old RPI Part #BUC009

PATIENT CABLE TYPE Found on Page #'s	FIXED 400-401	DIN/ UNSHIELDED 402-403	DUAL/ SHIELDED 404-405
<b>PATIENT, HOLTER &amp; TELEMETRY CABLES (continued)</b>			
<b>BURDICK/SIEMENS</b> E350, E350 I, E550, E560, EK-10, ECLIPSE LE, ECLIPSE LEI, ELITE & ELITE II		KKB003	
<b>BURDICK/SIEMENS</b> MA521 • Leadwire sets also available, see pages 408-419.			KCC034
<b>BURDICK/SIEMENS</b> MEDIC 3, MEDIC 4 & MEDIC 5 • Leadwire sets also available, see pages 408-419.	KCB002	KCA001	KCC003 <sup>1</sup> KEC010 <sup>2</sup>
<b>BURDICK/SIEMENS</b> SIRECUST 630 & SIRECUST DU • Leadwire sets also available, see pages 408-419.	KCB002	KCA001	KCC003
<b>CAMBRIDGE</b> VS-1, VS-2 & VS-3	KEB014 <sup>3</sup>		
<b>COLIN MED. INST.</b> BP 308, BP 308E, BP 408 & CMB 3000 • Leadwire sets also available, see pages 408-419.		KCA004	
<b>COROMETRICS</b> 115, 116, 118 & 151 ^ KCD033 (Patient Cable - 3 Lead Multi-Link <sup>®</sup> ), see page 405. • Leadwire sets also available, see pages 408-419.			KCD033^
<b>COROMETRICS</b> 505, 506, 515 & 515A • Leadwire sets also available, see pages 408-419.		KCA013	
<b>COROMETRICS</b> 556 • Leadwire sets also available, see pages 408-419.	KCB002	KCA001	
<b>CRITICARE SYS.</b> 1100 & 1508	KEB012		
<b>CRITICARE SYS.</b> 504 US • Leadwire sets also available, see pages 408-419.		KCA004	
<b>CRITICARE SYS.</b> 602-A USP & POET 2 • Leadwire sets also available, see pages 408-419.	KCB002	KCA001	KCC003 <sup>1</sup> KEC010 <sup>2</sup>
<b>CRITIKON INC.</b> 8700 SERIES, 9700 SERIES, DINAMAP, DINAMAP PLUS, DINAMAP PRO & DINAMAP MPS • Leadwire sets also available, see pages 408-419.	KCB008	KCA007	KCC009
<b>DATAMEDIX</b> SEE ELECTRODYNE/BECTON DICKINSON/DATAMEDIX/PPG			
<b>DATASCOPE</b> 2000 (RESP), 2001 (RESP), 2002 (RESP), 2100 (RESP), 2200 (RESP), EL (RESP) & PASSPORT (RESP) • Leadwire sets also available, see pages 408-419.	KCB002	KCA001	KCC003
<b>DATASCOPE</b> 2000 (ECG), 2001 (ECG), 2002 (ECG), 2100 (ECG), 2200 (ECG), 3000, BALLOON PUMP, MD-3, MD-3A, MD-4, PASSPORT (ECG), EL (ECG), PASSPORT XG, PASSPORT IL, PASSPORT XL, SPECTRUM, SYS 82, SYS 83, SYS 90, SYS 90T, SYS 97 & TRIO • Leadwire sets also available, see pages 408-419.		KCA016	
<b>DATASCOPE</b> TELEMETRY 3 LEAD ^ KCB028 (Telemetry cable), see page 406.	KCB028^		
<b>DATASCOPE</b> TELEMETRY 4 LEAD ^ KCB002 (Telemetry cable), see page 407.	KDB002^		
<b>DATASCOPE</b> TELEMETRY 5 LEAD ^ KEB015 (Telemetry cable), see page 407.	KEB015^		
<b>DATEX</b> 245P, AESPIRE, AS/3, AS/3 COMPACT, CARDIOCAP I, CARDIOCAP II, CS/3, S/5, S/5 COMPACT, S/5 LIGHT & SATELLITE PLUS • Leadwire sets also available, see pages 408-419.			KCC034 <sup>1</sup> KEC010 <sup>2</sup>

(continued)

# Patient, Holter & Telemetry Cables

PATIENT CABLE TYPE Found on Page #'s	FIXED 400-401	DIN/ UNSHIELDED 402-403	DUAL/ SHIELDED 404-405
---	------------------	-------------------------------	------------------------------

## PATIENT, HOLTER & TELEMETRY CABLES (continued)

<b>DMI</b> 3 CH RECORDER ^ <i>KGA001 (Holter cable), see page 406.</i> • Leadwire sets also available, see pages 408-419.		KGA001 <sup>^</sup>	
<b>ELECTRODYNE/BECTON DICKINSON/ DATAMEDIX/PPG</b> MD3A • Leadwire sets also available, see pages 408-419.			KEC010
<b>ELECTRODYNE/BECTON DICKINSON/ DATAMEDIX/PPG</b> GUARDIAN 1001 & GUARDIAN N1001 • Leadwire sets also available, see pages 408-419.	KCB002	KCA001	KCC003 <sup>1</sup> KEC010 <sup>2</sup>
<b>GE MEDICAL</b> SEE MARQUETTE/GE MEDICAL			
<b>HEWLETT PACKARD/AGILENT/ZYMED/ PHILIPS MEDICAL</b> <b>DEFIBRILLATOR (12 PIN):</b> M3500B & M5500B • Leadwire sets also available, see pages 408-419.		KCA010 <sup>1</sup> KEA005 <sup>2</sup>	KCC012 <sup>1</sup> KEC007 <sup>2</sup>
<b>HEWLETT PACKARD/AGILENT/ZYMED/ PHILIPS MEDICAL</b> <b>DEFIBRILLATOR (8 PIN):</b> M3500B & M5500B • Leadwire sets also available, see pages 408-419.		KCA022 <sup>1 4 5</sup> KCA025 <sup>1 5</sup> KEA017 <sup>2 5</sup>	
<b>HEWLETT PACKARD/AGILENT/ZYMED/ PHILIPS MEDICAL</b> <b>C3 BEDSIDE MONITOR:</b> 862474, 862475, 862478, 862479 & M1205A; <b>CODEMASTER XL &amp; DEFIBRILLATOR (12 PIN):</b> M1722A & M1722B; <b>DEFIBRILLATOR:</b> M3535A & M3536A; <b>ECG MODULE:</b> M1001B, M1002A & M1002B; <b>ECG MONITOR:</b> 78352C (12 PIN), M1001A, M1165A, M1166A & M1167A; <b>INTELL/VUE:</b> M8001A MP20, M8002A MP30, M8003A MP40, M8004A MP50, M8005A MP60, M8007A MP70 & M8010A MP90; <b>MERLIN CMS:</b> M1175A; <b>MMS PATIENT MONITOR:</b> M3001A; <b>NEONATAL MONITOR:</b> 78834C; <b>TELEMETRY MONITOR:</b> M2601A; <b>VERIDIA CMS:</b> M1177A; <b>VERIDIA PATIENT MONITOR:</b> M3000A, M3046A & M4375A • Leadwire sets also available, see pages 408-419.		KCA010 <sup>1</sup> KEA005 <sup>2</sup>	KCC012 <sup>1</sup> KEC007 <sup>2</sup>
<b>HEWLETT PACKARD/AGILENT/ZYMED/ PHILIPS MEDICAL</b> <b>CODEMASTER XL &amp; DEFIBRILLATOR (8 PIN):</b> M1723A & M1723B; <b>DEFIBRILLATOR:</b> 43100A (8 PIN), 43110A (8 PIN), 43110M, 43110MC, 43120A (8 PIN), 43200A, 78619A, 78620A, 78660A, 78660B, 78661A, 78661B, 78670A, 78671A; <b>ECG MODULE:</b> 78211A (8 PIN); <b>ULTRASOUND:</b> 77000A, 77020A, 77020AC, 77020AR, 77030A, 77035A, 77040A, M2400A, M2406A, M2475A (8 PIN), M2475B, SONOS 500, SONOS 4500, SONOS 5500, SONOS 7506 & 77025A SONOS • Leadwire sets also available, see pages 408-419.		KCA022 <sup>1 4 5</sup> KCA025 <sup>1 5</sup> KEA017 <sup>2 5</sup>	
<b>HEWLETT PACKARD/AGILENT/ZYMED/ PHILIPS MEDICAL</b> <b>CODEMASTER XL &amp; DEFIBRILLATOR (8 PIN):</b> M1722A & M1722B; <b>DEFIBRILLATOR (8 PIN):</b> M3500B + M5500B; <b>ECG MODULE:</b> 78208A & 78210A; <b>ECG MONITOR:</b> 778330A, 78331A, 78332A, 78333A, 78341A, 78342A, 78345A, 78346A, 78351A, 78352A (8 PIN), 78353A, 78353B, 78354A, 78532A, 78532B, 78534A, 78534B & 78534C • Leadwire sets also available, see pages 408-419.		KCA022 <sup>1 4 5</sup> KCA025 <sup>1 5</sup> KEA017 <sup>2 5</sup>	
<b>HEWLETT PACKARD/AGILENT/ZYMED/ PHILIPS MEDICAL</b> <b>DEFIBRILLATOR (6 PIN):</b> 43100A, 43110A, 43120A & M3921A; <b>PORTABLE PATIENT MONITOR:</b> M3921A • Leadwire sets also available, see pages 408-419.	KCB002	KCA001	KCC003

<sup>1</sup> 3 Leadwire Patient Cable    <sup>2</sup> 5 Leadwire Patient Cable    <sup>3</sup> Old RPI Part #BUC009  
<sup>4</sup> Old RPI Part #HPC008    <sup>5</sup> Pin colors are White, Green, & Black

PATIENT CABLE TYPE Found on Page #'s	FIXED 400-401	DIN/ UNSHIELDED 402-403	DUAL/ SHIELDED 404-405
---	------------------	-------------------------------	------------------------------

## PATIENT, HOLTER & TELEMETRY CABLES (continued)

<b>HEWLETT PACKARD/AGILENT/ZYMED/ PHILIPS MEDICAL</b> <b>EGG MONITOR:</b> 1500A, 1500B, 1504A, 1506A, 1511A & 1511B			KEB030 <sup>6</sup>
<b>HEWLETT PACKARD/AGILENT/ZYMED/ PHILIPS MEDICAL</b> <b>10 LEAD FIXED CABLE:</b> M1770A PAGewriter 300Pi, M1771A PAGewriter 200 & M1772A PAGewriter 100			KKB006
<b>HEWLETT PACKARD/AGILENT/ZYMED/ PHILIPS MEDICAL</b> <b>HOLTER MONITOR:</b> Tri-Track 1100-005 & Tri-Track 1100-008 ^ <i>KGA001 (Holter cable), see page 406.</i>			KGA001 <sup>^</sup>
<b>HEWLETT PACKARD/AGILENT/ZYMED/ PHILIPS MEDICAL</b> <b>78100A SAFETY TELEMETRY</b> ^ <i>KCB029 (Telemetry cable), see page 406.</i>			KCB029 <sup>7 ^</sup>
<b>HEWLETT PACKARD/AGILENT/ZYMED/ PHILIPS MEDICAL</b> <b>M2601A TELEMETRY TRANSMITTER</b> ^ <i>KCB031 (Telemetry cable), see page 406.</i> ^ <i>KCB032 (Telemetry cable), see page 407.</i> ^ <i>KEB018 (Telemetry cable), see page 407.</i> ^ <i>KEB019 (Telemetry cable), see page 407.</i>			KCB031 <sup>1 ^</sup> KCB032 <sup>1 ^</sup> KEB018 <sup>2 ^</sup> KEB019 <sup>2 ^</sup>
<b>HEWLETT PACKARD/AGILENT/ZYMED/ PHILIPS MEDICAL</b> <b>5 LEAD TELEMETRY:</b> DIGITRACK 2020 ^ <i>KEB015 (Telemetry cable), see page 407.</i>			KEB015 <sup>^</sup>
<b>HEWLETT PACKARD/AGILENT/ZYMED/ PHILIPS MEDICAL</b> <b>4 LEAD TELEMETRY</b> ^ <i>KCB002 (Telemetry cable), see page 407.</i>			KDB002 <sup>^</sup>
<b>HILL ROM</b> SEE AIR SHIELDS/HILL ROM/VICKER/NARCO			
<b>INSTROMEDIX</b> KING OF HEARTS ^ <i>KBB001 (Telemetry cable), see page 406.</i>			KBB001 <sup>^</sup>
<b>INVIVO RESEARCH</b> MILLENNIA, 3500 & 3550 • Leadwire sets also available, see pages 408-419.	KCB002	KCA001	KCC003 <sup>1</sup> KEC010 <sup>2</sup>
<b>INVIVO RESEARCH</b> OMNI-TRACK 300, M6, M12, NVS & TVS • Leadwire sets also available, see pages 408-419.		KCA004	KEC010
<b>IREX</b> SYSTEM III • Leadwire sets also available, see pages 408-419.			KCA013
<b>IREX</b> 880 • Leadwire sets also available, see pages 408-419.	KCB008	KCA007	KCC009
<b>IVY BIOMEDICAL</b> 101 (Before 1989), 402, 700 & 3100 • Leadwire sets also available, see pages 408-419.	KCB002	KCA001	KCC003
<b>KERNS &amp; WHITE</b> KEC-56 • Leadwire sets also available, see pages 408-419.			KCA013
<b>LASER SYSTEMS</b> VISTA1 • Leadwire sets also available, see pages 408-419.	KCB002	KCA001	KCC003
<b>LUMISCOPE</b> 5 LEAD ECG CABLE • Leadwire sets also available, see pages 408-419.			KEA017 <sup>5</sup>
<b>MARQUETTE/GE MEDICAL</b> 3 CH HOLTER CABLE ^ <i>KGA001 (Holter cable), see page 406.</i> • Leadwire sets also available, see pages 408-419.			KGA001 <sup>^</sup>

<sup>4</sup> Old RPI Part #HPC004    <sup>5</sup> Old RPI Part #HPC006    <sup>6</sup> Old RPI Part #HPC005  
<sup>7</sup> Pin colors are White, Red, & Black

(continued)

PATIENT CABLE TYPE Found on Page #'s	FIXED 400-401	DIN/ UNSHIELDED 402-403	DUAL/ SHIELDED 404-405
<b>PATIENT, HOLTER &amp; TELEMETRY CABLES (continued)</b>			
<b>MARQUETTE/GE MEDICAL</b>	KCB008 <sup>①</sup> KEB012 <sup>②</sup>	KCA007	KCC009
900 DEFIB SERIES, 1200 DEFIB SERIES, & 1500 DEFIB SERIES • Leadwire sets also available, see pages 408-419.			
<b>MARQUETTE/GE MEDICAL</b>	KKB012		
1200 ST, HELDIGE MICROSMART, MAC 1200 & MAC 1600			
<b>MARQUETTE/GE MEDICAL</b>			
APEXPRO TELEMETRY UNITS • Leadwire sets also available, see pages 408-419.			
<b>MARQUETTE/GE MEDICAL</b>	GEC021 <sup>^</sup>		
CASE, CASE 8000, MAC 5000 & MAC 5000 ST <sup>^</sup> GEC020 (Acquisition Module cable), see page 405. • Leadwire sets also available, see pages 408-419.			
<b>MARQUETTE/GE MEDICAL</b>	GEC020 <sup>^</sup>		
CASE 12, CASE 15, CASE 16, CENTRA, MAC 6, MAC 8, MAC 12, MAC PC, MAC VU & MAX-PERSONAL <sup>^</sup> GEC020 (Acquisition Module cable), see page 405.			
<b>MARQUETTE/GE MEDICAL</b>		KCA019 <sup>①</sup> KEA001 <sup>②</sup>	KCC021 <sup>①</sup> KEC003 <sup>②</sup> KED021 <sup>②</sup> <sup>^</sup>
DASH 2000 PRO, DASH 3000 PRO, DASH 4000 PRO, DINAMAP PRO 100, EAGLE SYSTEMS, MAC-LAB, SOLAR 3000, SOLAR 8000, SOLAR 9500, TRAM 100, TRAM 200, TRAM 300, TRAM 400, TRAM 500, TRAM 600, TRAM 800, TRAM AR & UNITY SYSTEMS <sup>^</sup> KED021 (Patient Cable - 5 Lead Multi-Link <sup>®</sup> ), see page 405. • Leadwire sets also available, see pages 408-419.			
<b>MARQUETTE/GE MEDICAL</b>	KKB007		
HELLIGE EK-51			
<b>MATRIX MEDICAL</b>	KCB002	KCA001	KCC003
LIFE DEFENSE PLUS (DEFIB) • Leadwire sets also available, see pages 408-419.			
<b>MDE</b>			
SEE MEDICAL DATA ELEC.			
<b>MEDICAL DATA ELEC. (MDE)</b>	KCB008		
400673			
<b>MEDICAL DATA ELEC. (MDE)</b>	KCB002	KCA001	KCC003
ESCORT 100, ESCORT 101, ESCORT 102, ESCORT 200, ESCORT 300 & PRISM (WITHOUT 90° CONNECTOR) • Leadwire sets also available, see pages 408-419.			
<b>MEDICAL DATA ELEC. (MDE)</b>		KCA010 <sup>①</sup> KEA005 <sup>②</sup>	KCC012 <sup>①</sup> KEC007 <sup>②</sup>
ESCORT W/ HP OPTION • Leadwire sets also available, see pages 408-419.			
<b>MEDICAL DATA ELEC. (MDE)</b>	KCB028 <sup>^</sup>		
3 LEAD TELEMETRY <sup>^</sup> KCB028 (Telemetry cable), see page 406.			
<b>MEDICAL DATA ELEC. (MDE)</b>	KEB015 <sup>^</sup>		
5 LEAD TELEMETRY <sup>^</sup> KEB015 (Telemetry cable), see page 407.			
<b>MEDICAL RESEARCH LABS</b>	KCB002	KCA001	KCC003
260SL, 450SL, 521A, PRE-AMP 450, PORTAPAK 80, PORTAPAK 90 & PORTAPAK 1000 ISOLATED • Leadwire sets also available, see pages 408-419.			
<b>MEDTRONIC</b>			
SEE PHYSIO CONTROL/MEDTRONIC			
<b>MENNEN MEDICAL</b>	KDB002 <sup>^</sup>		
TELEMETRY 4 LEAD <sup>^</sup> KDB002 (Telemetry cable), see page 407.			
<b>MENNEN MEDICAL</b>	KEB015 <sup>^</sup>		
TELEMETRY 5 LEAD <sup>^</sup> KEB015 (Telemetry cable), see page 407.			
<b>MIDMARK</b>	KEB020 <sup>^</sup>		
IQ MARK <sup>^</sup> KEB020 (Holter cable), see page 406.			

① 3 Leadwire Patient Cable      ② 5 Leadwire Patient Cable      ③ Old RPI Part #BUC009  
④ Old RPI Part #HPC008      ⑤ Pin colors are White, Green, & Black

PATIENT CABLE TYPE Found on Page #'s	FIXED 400-401	DIN/ UNSHIELDED 402-403	DUAL/ SHIELDED 404-405
<b>PATIENT, HOLTER &amp; TELEMETRY CABLES (continued)</b>			
<b>MINDRAY</b>		KEA005	KEC007
BENEVIEW T5, BENEVIEW T6, BENEVIEW T8 & MPM MODULE • Leadwire sets also available, see pages 408-419.			
<b>MORTARA INC.</b>	KKB007		
ELI 250			
<b>MTM</b>		KEA004 <sup>^</sup>	
2 CH HOLTER CABLE <sup>^</sup> KEA004 (Holter cable), see page 406. • Leadwire sets also available, see pages 408-419.			
<b>MTM</b>		KGA001 <sup>^</sup>	
3 CH HOLTER CABLE <sup>^</sup> KGA001 (Holter cable), see page 406. • Leadwire sets also available, see pages 408-419.			
<b>NARCO</b>			
SEE AIR SHIELDS/HILL ROM/VICKER/NARCO			
<b>NELLCOR/PURTAN BENNET</b>	KCB002	KCA001	KCC003 <sup>①</sup> KEC010 <sup>②</sup>
791018, MBP-4000, N-200, N-250 & N-1000 • Leadwire sets also available, see pages 408-419.			
<b>NIHON KODEN</b>	KKB002		
ECG: 5151A, 5403A, 6151A, 6306A, 6353A, 6543A, 6551A, 7514A, 8110A, 8240A, 8330A, 8350A, 8370A & 9340A			
<b>NIHON KODEN</b>		KCA004	KEC010
BSM-8301A, BSM-8302, BSM-8500A, BSM-8502, OEC-5102A (Serial#20156), OEC-6105A (Serial#>22026), OEC-7102A, OEC-8108, TEC-5200A, TEC-7100A, TEC-7200A, TEC-7300A & 8000 SERIES (DEFIB) • Leadwire sets also available, see pages 408-419.			
<b>NORTH AMERICAN DRAEGER</b>		KCA004	KEC010
VITALERT 1000 & VITALERT 2000 • Leadwire sets also available, see pages 408-419.			
<b>NOVAMATRIX MED</b>		KCA004	KEC010
LIFE DEFENSE 1 • Leadwire sets also available, see pages 408-419.			
<b>PACE TECH</b>	KCB002	KCA001	KCC003
MINIMAX 4000CL, MINIPACK 300, MINIPACK 3000, MINIPACK 3100, VITALMAX 2100, VITALMAX 2200, VITALMAX 4000, VITALMAX 4000CL, VITALMAX 4100 & VITALMAX 800 PLUS • Leadwire sets also available, see pages 408-419.			
<b>PARKS ELECTRONICS</b>		KEA004 <sup>^</sup>	
2 CH HOLTER CABLE <sup>^</sup> KEA004 (Holter cable), see page 406. • Leadwire sets also available, see pages 408-419.			
<b>PC SCIENTIFIC</b>		KEA004 <sup>^</sup> KGA001 <sup>^^</sup>	
2 CH HOLTER CABLE 3 CH HOLTER CABLE <sup>^</sup> KEA004 (Holter cable), see page 406. <sup>^^</sup> KGA001 (Holter cable), see page 406. • Leadwire sets also available, see pages 408-419.			
<b>PHILIPS MEDICAL</b>			
SEE HEWLETT PACKARD/AGILENT/ZYMED/PHILIPS MEDICAL			
<b>PHYSIO CONTROL/MEDTRONIC</b>	KEB012		
LIFEPAK 6			
<b>PHYSIO CONTROL/MEDTRONIC</b>	KCB036	KCA035	
LIFEPAK 12 & LIFEPAK 20 • Leadwire sets also available, see pages 408-419.			
<b>PHYSIO CONTROL/MEDTRONIC</b>	KCB008 <sup>①</sup> KEB012 <sup>②</sup>	KCA007	KCC009
LIFEPAK 5, LIFEPAK 7, LIFEPAK 8, LIFEPAK 9, LIFEPAK 10, LIFEPAK 510, VSM-1, VSM-2, VSM-2ESF & VSM-3 W/O RESISTORS • Leadwire sets also available, see pages 408-419.			

① Old RPI Part #HPC004      ② Old RPI Part #HPC006      ③ Old RPI Part #HPC005  
④ Pin colors are White, Red, & Black

(continued)

# Patient, Holter & Telemetry Cables

PATIENT CABLE TYPE Found on Page #'s	FIXED 400-401	DIN/ UNSHIELDED 402-403	DUAL/ SHIELDED 404-405
---	------------------	-------------------------------	------------------------------

## PATIENT, HOLTER & TELEMETRY CABLES (continued)

<b>PIC</b> SEE ACCUCORE/PIC/VITAL.COM			
<b>PPG</b> SEE ELECTRODYNE/BECTON DICKINSON/DATAMEDIX/PPG			
<b>PROTOCOL SYS./WELCH ALLYN</b> PROPAQ 206 EL (HP OPTION) • Leadwire sets also available, see pages 408-419.			KCC012 <sup>①</sup> KCA010 <sup>②</sup>
<b>PROTOCOL SYS./WELCH ALLYN</b> 6200, ATLAS, ENCORE, PROPAQ 102, PROPAQ 103, PROPAQ 104, PROPAQ 106, PROPAQ CS & ULTRASMART • Leadwire sets also available, see pages 408-419.	KCB002	KCA001	KCC003
<b>PURTAN BENNET</b> SEE NELLCOR/PURTAN BENNET			
<b>QUINTON</b> Q-STRESS ^ KKB010 (Patient Cable - 10 Lead Fixed Pinch), see page 401. ^^ KKB011 (Patient Cable - 10 Lead Fixed Snap), see page 401.	KKB010^ KKB011^^		
<b>QUINTON</b> Q-TEL 3LD TELEMETRY ^ KCB028 (Telemetry cable), see page 406.	KCB028^		
<b>QUINTON</b> Q-TEL 4LD TELEMETRY ^ KDB002 (Telemetry cable), see page 407.	KDB002^		
<b>QUINTON</b> 365 ^ KEB015 (Telemetry cable), see page 407.	KEB015^		
<b>ROZINN ELECTRONICS</b> 151 3 CH 7 LD ^ KGA001 (Holter cable), see page 406. • Leadwire sets also available, see pages 408-419.		KGA001^	
<b>ROZINN ELECTRONICS</b> 151 3 CH 5 LD ^ KEA004 (Holter cable), see page 406. • Leadwire sets also available, see pages 408-419.		KEA004^	
<b>SCHILLER</b> 3 CH HOLTER ^ KGA001 (Holter cable), see page 406. • Leadwire sets also available, see pages 408-419.		KGA001^	
<b>SCHILLER</b> AT-1, AT-2, AT-2 PLUS & AT-10	KKB007		
<b>SIEMENS</b> SEE BURDICK/SIEMENS			
<b>SIMONSEN &amp; WELLS</b> 3 LD TELEMETRY ^ KCB028 (Telemetry cable), see page 406.	KCB028^		
<b>SIMONSEN &amp; WELLS</b> 4 LD TELEMETRY ^ KDB002 (Telemetry cable), see page 407.	KDB002^		
<b>SIMONSEN &amp; WELLS</b> 8000 (New Generation), Athena, Diascope 1 & Diascope 2 • Leadwire sets also available, see pages 408-419.			KCC034
<b>SPACE LABS</b> ULTRAVIEW MONITORS (90496) • Leadwire sets also available, see pages 408-419.			KEC016
<b>SPACE LABS</b> 900 RESP W/O RESISTORS	KEB012		
<b>SPACE LABS</b> 400 Series, 500 Series, 900 Series, 701S, 703S, 720S, 4045, 90408, 90418, 90470, 90600 Series, 90700 SERIES, TEK-413, TEK-414, TEK-511, TEK-512, TEK-514 & TEK-521 • Leadwire sets also available, see pages 408-419.		KCA004	KEC010

PATIENT CABLE TYPE Found on Page #'s	FIXED 400-401	DIN/ UNSHIELDED 402-403	DUAL/ SHIELDED 404-405
---	------------------	-------------------------------	------------------------------

## PATIENT, HOLTER & TELEMETRY CABLES (continued)

<b>TEMTECH</b> LIFEGUARD 9, M401, M501 & M503	KEB012		
<b>VICKER</b> SEE AIR SHIELDS/HILL ROM/VICKER/NARCO			
<b>VITAL.COM</b> SEE ACCUCORE/PIC/VITAL.COM			
<b>WELCH ALLYN</b> SEE PROTOCOL SYS./WELCH ALLYN			
<b>ZOLL</b> D-90, M SERIES, PD-1200, PD-1400, PD-1600 & PD-2000 • Leadwire sets also available, see pages 408-419.	KCB002	KCA001	
<b>ZYMED</b> SEE HEWLETT PACKARD/AGILENT/ZYMED/PHILIPS MEDICAL			

① 3 Leadwire Patient Cable  
⑦ Old RPI Part #HPC008

② 5 Leadwire Patient Cable  
⑧ Pin colors are White, Green, & Black

③ Old RPI Part #BUC009

④ Old RPI Part #HPC004  
⑨ Pin colors are White, Red, & Black

⑤ Old RPI Part #HPC006

⑥ Old RPI Part #HPC005

**RPI Part #BUK041**  
**OEM Part #844842**

**LEAD SELECTOR KNOB**  
• Size: ~1.13" OD x .77" lg.  
• Shaft size: 1/4"  
• Includes: Set screws  
**Fits:** Control Panel  
**Models:** EK-5 & EK-5A

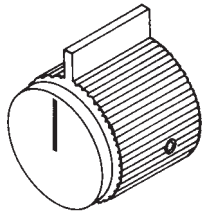

**RPI Part #BUK042**  
**OEM Part #844845**

**SENSITIVITY KNOB**  
• Size: ~.91" OD x .64" lg.  
• Shaft size: 1/4"  
• Includes: Set screws  
**Fits:** Control Panel  
**Models:** EK-5 & EK-5A

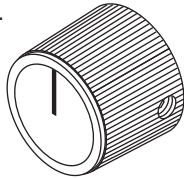

**RPI Part #BUK043**  
**OEM Part #844846**

**POSITION CONTROL KNOB**  
• Size: ~.72" OD x .58" lg.  
• Shaft size: 1/4"  
• Includes: Set screws  
**Fits:** Control Panel  
**Models:** EK-5 & EK-5A

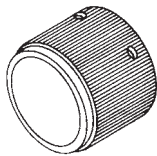

**RPI Part #CAF011**  
**OEM Part # 850404**

**RUBBER FOOT**  
• 4 per package  
• Material: Black rubber with molded in steel washer  
• Size: ~.75" OD x .50" lg.; #10 clearance hole  
**Fits:** Base Plate  
**Models:** EK-5, EK-5A, EK-6, EK-7, EK-8 & EK-670; DC-185, DC-190, E600, E500TW, MC-600 & TMS-302



**RPI Part #BUR011**  
**OEM Part #860405**

**DRIVE ROLLER**  
**Fits:** Back Plate and Center Plate  
**Models:** EK-5 & EK-5A

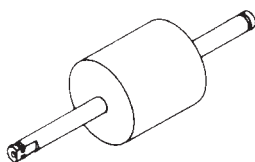

**RPI Part #BUB012**  
**OEM Part #850402**  
**Industry Part #80XL025**

**TIMING DRIVE BELT**  
**Fits:** Drive Pulley  
**Models:** EK-5 & EK-5A

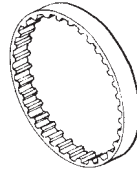

**RPI Part #BUB013**  
**OEM Part #850502**  
**Industry Part #130XL025**

**TIMING BELT**  
**Fits:** Drive Pulley  
**Models:** E100, E200, E310, E320, EK-8 & EK-670 (Serial #5999 and below)

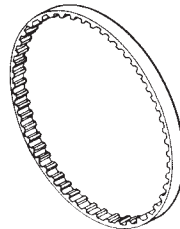

**RPI Part #BUB014**  
**OEM Part #850557**  
**Industry Part #140XL025**

**TIMING BELT**  
**Fits:** Drive Pulley  
**Model:** EK-670 (Serial #6000 and above)

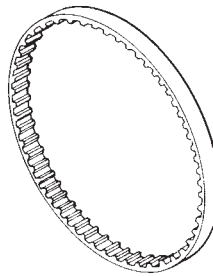

**RPI Part #BUB027**  
**OEM Part #833028**

**CIRCUIT BREAKER**  
• 0.5A@250VAC; 28VDC  
• Includes: Mounting hardware  
**Fits:** Power Panel  
**Model:** EK-5A

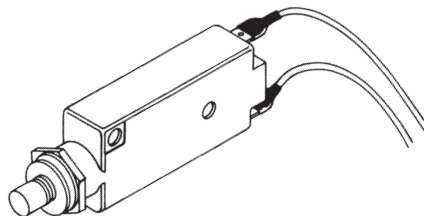

**RPI Part #BUS005**  
**OEM Part #860344**

**RECORD STYLUS**  
**Fits:** Galvanometer Assembly  
**Models:** EK-3 & EK-4

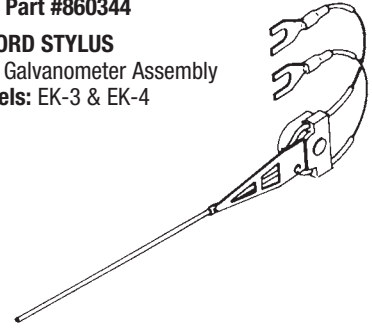

**RPI Part #BUS006**  
**OEM Part #860289**

**MARKING STYLUS**  
**Fits:** Recording Assembly  
**Model:** EK-3

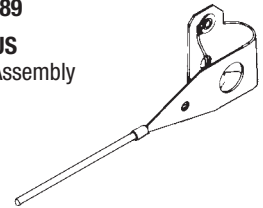

**RPI Part #BUS007**  
**OEM Part #860343**

**MARKING STYLUS**  
**Fits:** Recording Assembly  
**Model:** EK-4

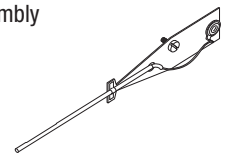

**RPI Part #BUS008**  
**OEM Part #860496**

**RECORD STYLUS**  
**Fits:** Galvanometer Assembly  
**Models:** EK-5, EK-5A & EK-6

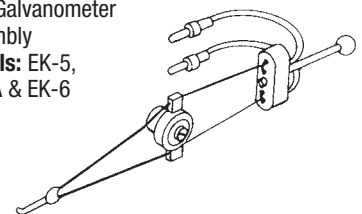

**RPI Part #BUS025**  
**OEM Part #861099**

**RECORD STYLUS**  
**Fits:** Galvanometer Assembly  
**Models:** E100, E200, E310, E320, EK-7, EK-8 & EK-670

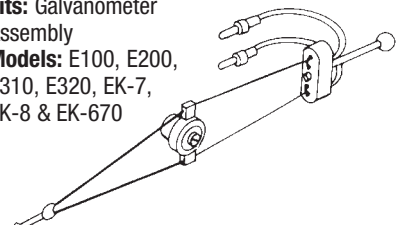

# General Biomedical Equipment

Models: Atria 3000, DC Series, E Series, Eclipse Series, EK Series, Elite, MC Series, Medic Series, MW Series, PA Series, Sirecust Series, TMS Series & UT Series

**RPI Part #BUT034**  
**OEM Part #860497**

**TRANSDUCER ELEMENT**  
**Fits:** Galvanometer Assembly  
**Models:** EK-5 & EK-5A

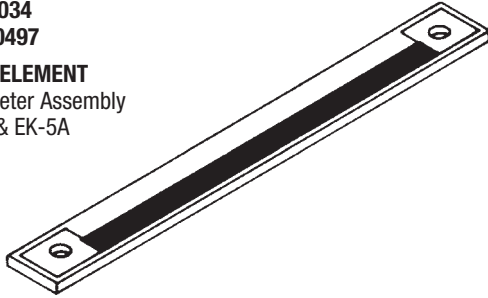

**RPI Part #BUC028**  
**OEM Part #813004**

**CAPACITOR**  
• 1000 MFD, 25VDC electrolytic  
**Fits:** Chassis  
**Model:** EK-5A

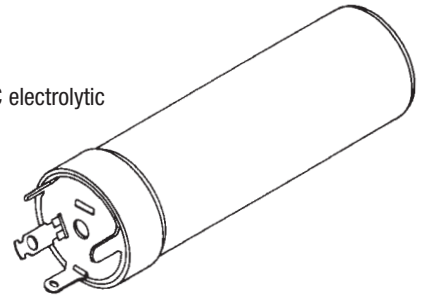

**RPI Part #BUS030**  
**OEM Part #827785**

**POWER SWITCH**  
• DPST  
• 6A@125VAC;  
3A@250VDC  
• Includes: Mounting hardware  
**Fits:** Control Panel  
**Models:** DC-180, DC-185,  
EK-5 & EK-5A

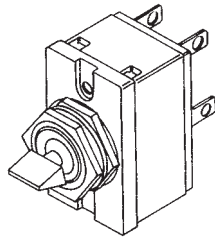

**RPI Part #BUS032**  
**OEM Part #827795**

**MARKER SWITCH**  
• Normally Open  
• 3A@125VAC; 4A@14VDC  
• Includes: Mounting hardware  
**Fits:** Control Panel  
**Models:** DC-175,  
DC-195, EK-5A,  
PA-100, PA-101,  
PA-104 & PA-107

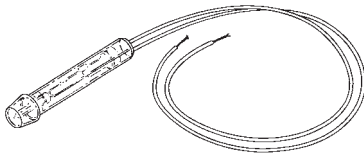
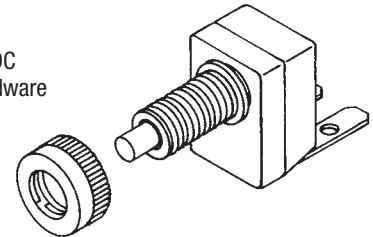

**RPI Part #BUL026**  
**OEM Part #831742**

**PILOT LIGHT (RED)**  
• 125VAC, 1/2W  
**Fits:** Control Panel  
**Model:** EK-5A

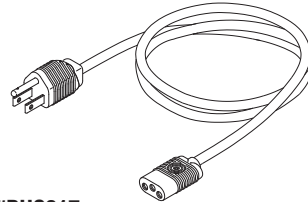

**RPI Part #BUC017**  
**OEM Part #097152**

**POWER CORD**  
• Length: ~8 ft.  
• 18/3 SJT, 60°C; 7A@125VAC  
• Plug Type: NEMA 5-15P  
• Connector Type: BMI-3  
• Color: Gray  
**Fits:** AC Connector  
**Models:** EK-1, EK-2, EK-3, EK-4,  
EK-5, EK-5A & EK-8

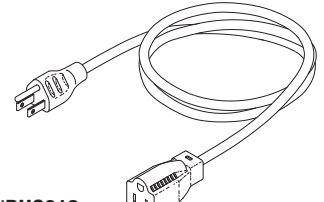

**RPI Part #BUC018**  
**OEM Part #** (No OEM Part # Available)

**EXTENSION CORD**  
• Length: ~8 ft.  
• 16/3 SJT, 60°C; 13A@125VAC  
• Plug Type: NEMA 5-15P  
• Connector Type: NEMA 5-15R  
• Color: Black  
**Fits:** AC Connector  
**Models:** Diathermy: MW200 & MW225;  
Ultrasound: UT420 & UT4300

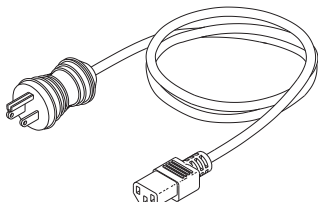

**RPI Part #RPC557**  
**OEM Part #** (No OEM Part # Available)

**HOSPITAL GRADE POWER CORD**  
• Length: ~8 ft.  
• 16/3 SJT, 60°C; 13A@125VAC  
• Plug Type: NEMA 5-15P  
• Connector Type: EN60320-C13  
• Color: Cool gray  
**Fits:** Power Input Module  
**Model:** EK-10

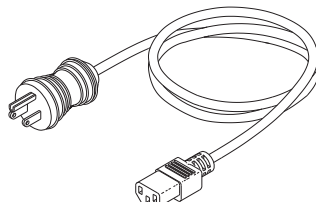

**RPI Part #RPC558**  
**OEM Part #** (No OEM Part # Available)

**HOSPITAL GRADE POWER CORD**  
• Length: ~18 ft.  
• 16/3 SJT, 60°C; 13A@125VAC  
• Plug Type: NEMA 5-15P  
• Connector Type: EN60320-C13  
• Color: Cool gray  
**Fits:** Power Input Module  
**Model:** EK-10

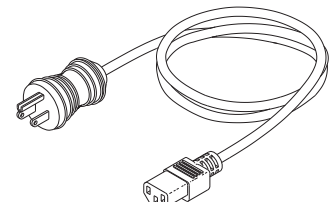

**RPI Part #RPC559**  
**OEM Part #** (No OEM Part # Available)

**HOSPITAL GRADE POWER CORD**  
• Length: ~25 ft.  
• 16/3 SJT, 60°C; 13A@125VAC  
• Plug Type: NEMA 5-15P  
• Connector Type: EN60320-C13  
• Color: Cool gray  
**Fits:** Power Input Module  
**Model:** EK-10



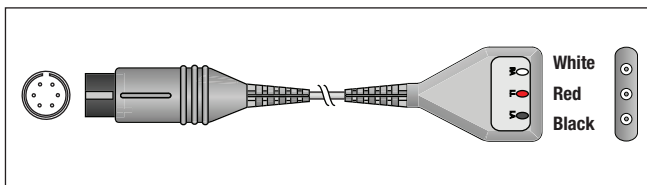

**RPI Part #KCA001**  
**OEM Part #** (No OEM Part # Available)

**PATIENT CABLE - 3 LEAD DIN**

- Number of leads: 3
  - Length: ~10 ft.
  - Equipment End: 6-Pin; 1K  $\Omega$  Resistors; Jumper E to C
  - Patient End: Din/Unshielded; .060" Pin (Safety)
  - Color: White, Red, and Black
  - Also available: Leadwire Adapter Kit (RPI Part #LAK001)
  - Suggested Leadwire Sets: Reusable Leadwire Sets (RPI Part #'s LKM002 and LKM005), Disposable Leadwire Sets (RPI Part #'s LDM301 and LDM308), and Veterinary Leadwire Set (RPI Part #LVM701)
- Models:** Medic 3, Medic 4, Medic 5, Sirecust 630 & Sirecust DU

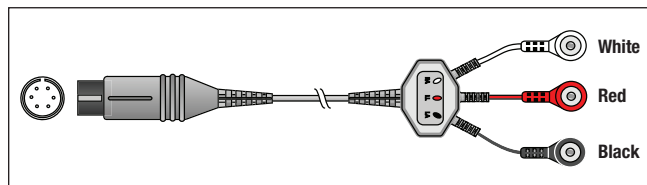

**RPI Part #KCB002**  
**OEM Part #** (No OEM Part # Available)

**PATIENT CABLE - 3 LEAD FIXED SNAP**

- Number of leads: 3
  - Length: ~11 ft.
  - Equipment End: 6-Pin; 1K  $\Omega$  Resistors; Jumper E to C
  - Patient End: Fixed Snap
  - Color: White, Red, and Black
- Models:** Medic 3, Medic 4, Medic 5, Sirecust 630 & Sirecust DU

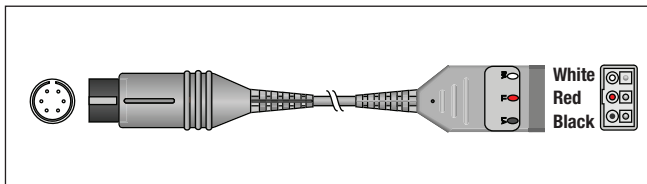

**RPI Part #KCC003**  
**OEM Part #** (No OEM Part # Available)

**PATIENT CABLE - 3 LEAD DUAL**

- Number of leads: 3
  - Length: ~10 ft.
  - Equipment End: 6-Pin; 1K  $\Omega$  Resistors; Jumper E to C
  - Patient End: Dual/Shielded; .060" Pin (Safety)
  - Color: White, Red, and Black
  - Suggested Leadwire Sets: Reusable Leadwire Sets (RPI Part #'s LKM014 and LKM017), Disposable Leadwire Sets (RPI Part #'s LDM305 and LDM312), and Veterinary Leadwire Set (RPI Part #LVM705)
- Models:** Medic 3, Medic 4, Medic 5, Sirecust 630 & Sirecust DU

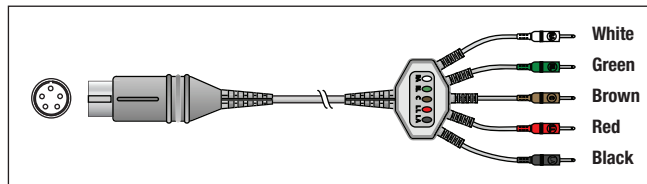

**RPI Part #KEB014**  
**OLD RPI Part #BUC009**  
**OEM Part #** (No OEM Part # Available)

**PATIENT CABLE - 5 LEAD FIXED PIN**

- Number of leads: 5
  - Length: ~8 ft.
  - Equipment End: 5-Pin
  - Patient End: Fixed .125" Pin
  - Color: White, Green, Brown, Red, and Black
  - Also available: Leadwire Adapter Kit (RPI Part #LAK001)
- Models:** EK-1, EK-2, EK-3, EK-4, EK-5 & EK-5A

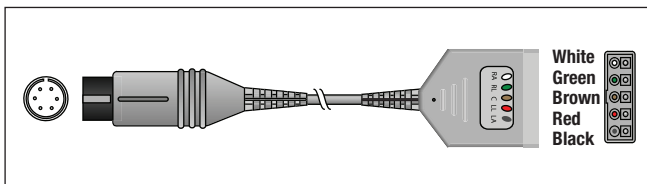

**RPI Part #KEC010**  
**OEM Part #** (No OEM Part # Available)

**PATIENT CABLE - 5 LEAD DUAL**

- Number of leads: 5
  - Length: ~10 ft.
  - Equipment End: 6-Pin; 1K  $\Omega$  Resistors
  - Patient End: Dual/Shielded; .060" Pin (Safety)
  - Color: White, Green, Brown, Red, and Black
  - Suggested Leadwire Sets: Reusable Leadwire Sets (RPI Part #'s LKM032 and LKM035), Disposable Leadwire Sets (RPI Part #'s LDM307 and LDM314), and Veterinary Leadwire Set (RPI Part #LVM707)
- Models:** Medic 3, Medic 4 & Medic 5

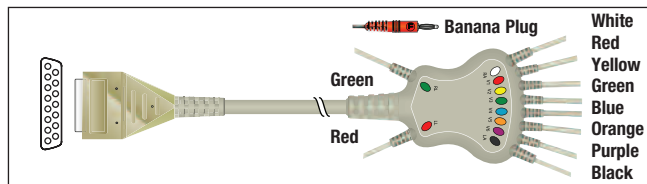

**RPI Part #KKB003**  
**OEM Part #** (No OEM Part # Available)

**PATIENT CABLE - 10 LEAD FIXED BANANA**

- Number of leads: 10
  - Length: ~10 ft.
  - Equipment End: 15-Pin D-Sub
  - Patient End: Fixed Banana Plug
  - Color: White, Red, Yellow, Green, Blue, Orange, Purple, and Black
  - Also available: Leadwire Adapter Kit (RPI Part #LAK001)
- Models:** E350, E350 I, E550, E560, Eclipse, Eclipse LE, Eclipse LEI, Elite, Elite II & EK-10

(Continued on next page)

# General Biomedical Equipment

Models: Atria 3000, DC Series, E Series, Eclipse Series, EK Series, Elite, MC Series, Medic Series, MW Series, PA Series, Sirecust Series, TMS Series & UT Series

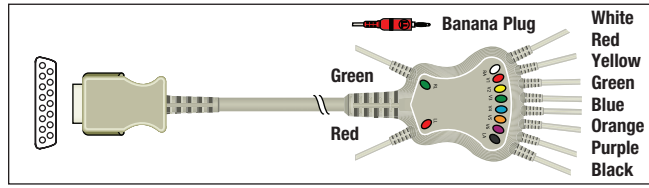

**RPI Part #KKB008**

**OEM Part #** (No OEM Part # Available)

**PATIENT CABLE - 10 LEAD FIXED BANANA**

- Number of leads: 10
- Length: 10 ft.
- Equipment End: 15-Pin D-Sub; 10K Ω Resistors
- Patient End: Fixed Banana Plug
- Color: White, Red, Yellow, Green, Blue, Orange, Purple, and Black
- Also available: Leadwire Adapter Kit (RPI Part #LAK001)

**Model:** Atria 3000, Eclipse 4, Eclipse 400, Eclipse 8, Eclipse 800, Eclipse 850, Eclipse LE II & Plus

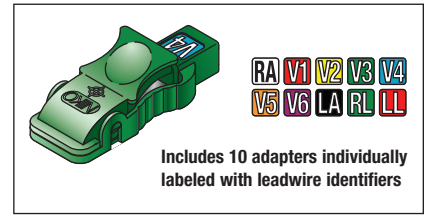

Includes 10 adapters individually labeled with leadwire identifiers

**RPI Part #LAK001**

**OEM Part #** (No OEM Part # Available)

**LEADWIRE ADAPTER KIT**

- Includes: 10 adapters individually labeled with leadwire identifiers
- Adapts banana plugs or pins to tab or snap electrodes
- Widest contact area for superior trace quality
- Flat, wide bodied design helps prevent twisting
- Durable construction - built to last

**Model: Burdick:** Atria 3000, E350, E350 I, E550, E560, Eclipse, Eclipse 4, Eclipse 400, Eclipse 8, Eclipse 800, Eclipse 850, Eclipse LE, Eclipse LEI, Eclipse LE II, Eclipse Plus, EK-1, EK-2, EK-3, EK-4, EK-5, EK-5A, EK-10 & Elite

**NOTES:**

---

---

---

---

---

---

---

---

---

---

---

---

---

---

---

---

---

---

---

---

---

---

---

---

**RPI Part #GEP004**  
**OEM Part #320413**

**PUMP ASSEMBLY**

- Includes: Tubing (RPI Part #RPT645), Barbed Elbow Fitting (RPI Part #RPF641), Check Valve (RPI Part #RPV642), mounting bracket, hardware, pump and wire harness

**Fits:** Chassis

**Models:** Dinamap 8100, 8100T, 9300 & 9340

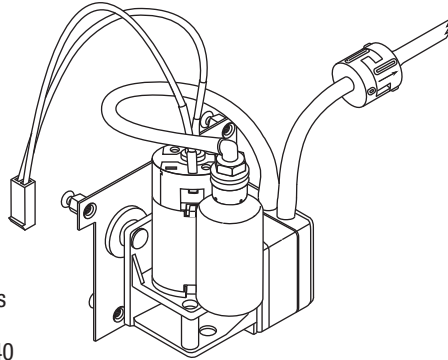

**RPI Part #RPT645**  
**OEM Part #740107**

**TUBING**

- 1/8" ID x 1/4" OD
- Opaque Beige
- Blended Silicone
- Sold by the foot (Reel not included)
- USP class VI certified
- Temperature rated: -75 to 275°F; maximum pressure: 19 PSI
- Autoclavable

**Fits:** Pump Assembly

**Models:** Dinamap 8100, 8100T, 9300 & 9340

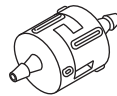
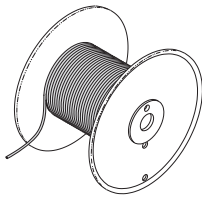

**RPI Part #RPV642**  
**OEM Part # 754116**

**CHECK VALVE**

- 1/8" Barbs
- Polypropylene
- Cracking pressure: 0.11 PSI

**Fits:** Pump Assembly

**Models:** Dinamap 8100, 8100T, 9300 & 9340

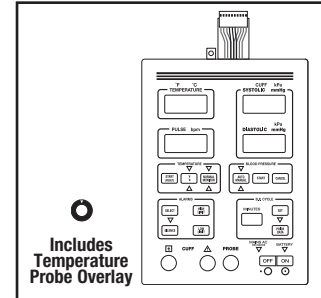

Includes Temperature Probe Overlay

**RPI Part #GEK001**  
**OEM Part #300918**

**FRONT PANEL OVERLAY - 8100T**

- Includes: Temperature probe overlay

**Fits:** Front Panel

**Model:** Dinamap 8100T

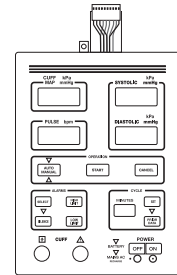

**RPI Part #GEK002**  
**OEM Part #701252**

**FRONT PANEL OVERLAY - 8100**

**Fits:** Front Panel

**Model:** Dinamap 8100

**RPI Part #GEC009**  
**OEM Part #316339**

**TEMPERATURE PROBE CONNECTOR**

- Includes: Temperature probe overlay, 1/2" retaining ring and (1 piece) 4" White Cable Tie (RPI Part #RPT083)

- Wires to board

**Fits:** Case Bracket

**Model:** Dinamap 8100T

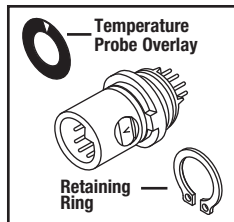
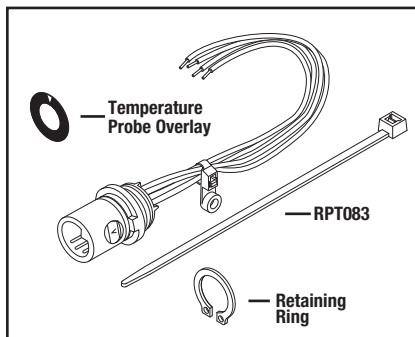

**RPI Part #GEC008**  
**OEM Part #300681**

**TEMPERATURE PROBE CONNECTOR**

- Includes: Temperature probe overlay and 1/2" retaining ring

- Board mounted

**Fits:** Display PCB

**Model:** Dinamap 8100T

**RPI Part #GEP014**  
**OEM Part #320438**

**CALIBRATION PLUG**

- 6,090Ω ± 1% between pins 3 and 6

**Fits:** Temperature Probe Connector

**Model:** Dinamap 8100T

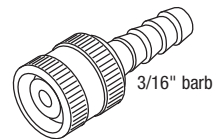
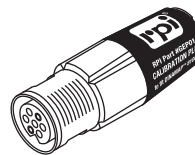

**RPI Part #GEC012**  
**OEM Part #754505**

**QUICK CONNECT (3/16" FEMALE)**

- Material: Brass
- 5/16-24 screw connector with a 3/16" barb

- Includes: (1 piece) O-Ring (RPI Part #RP0313)

**Fits:** Dual Tubing Set

**Models:** 8100 & 8100T

**RPI Part #RP0312**  
**OEM Part #300593**  
**Industry Part #AS568-004**

**O-RING**

- 12 per package
- .070" ID x .210" OD x .070" X-Sec
- Material: Nitrile (Buna N); Duro: 70
- Included in: O-Ring Kit (RPI Part #RPK404)

**Fits:** Quick Connect (3/16" Female) (RPI Part #GEC012)

**Models:** 8100 & 8100T



Actual size

# General Biomedical Equipment

Models: DINAMAP™ 8100, 8100T, 8110, 8120, 9300, 9340, 9350, 9400 & 9500XL

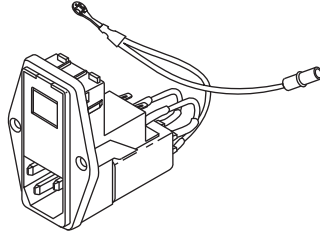

**RPI Part #GEM015**  
**OEM Part #320431**

**POWER INPUT MODULE**

- Includes installed fuse holders and (2 pieces) 1/2A @ 250VAC Fuse (RPI Part #RPF043)

**Fits:** Chassis

**Models:** Dinamap 8100 & 8100T

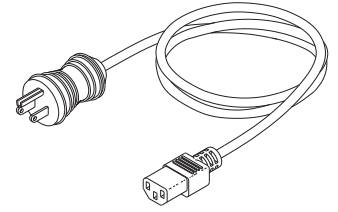

**RPI Part #RPC558**

**OEM Part #** (No OEM Part # Available)

**HOSPITAL GRADE POWER CORD**

- Length: ~18 ft.
- 16/3 SJT, 60°C: 13A@125VAC
- Plug Type: NEMA 5-15P
- Connector Type: EN60320-C13
- Color: Cool gray

**Fits:** Power Input Module

**Models:** Dinamap 8100 & 8100T

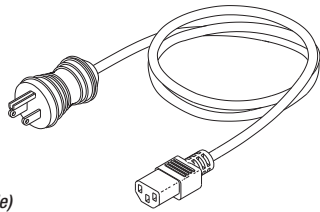

**RPI Part #RPC557**

**OEM Part #** (No OEM Part # Available)

**HOSPITAL GRADE POWER CORD**

- Length: ~8 ft.
- 16/3 SJT, 60°C: 13A@125VAC
- Plug Type: NEMA 5-15P
- Connector Type: EN60320-C13
- Color: Cool gray

**Fits:** Power Input Module

**Models:** Dinamap 8100 & 8100T

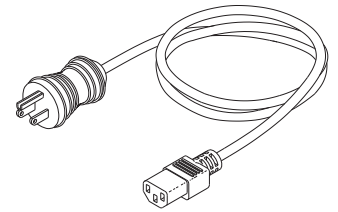

**RPI Part #RPC559**

**OEM Part #** (No OEM Part # Available)

**HOSPITAL GRADE POWER CORD**

- Length: ~25 ft.
- 16/3 SJT, 60°C: 13A@125VAC
- Plug Type: NEMA 5-15P
- Connector Type: EN60320-C13
- Color: Cool gray

**Fits:** Power Input Module

**Models:** Dinamap 8100 & 8100T

**NOTES:**

---



---



---



---



---



---



---



---



---



---



---



---



---



---



---



---



---



---



---



---











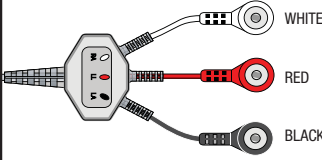

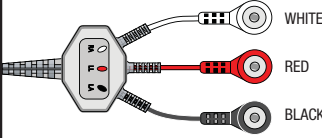
---

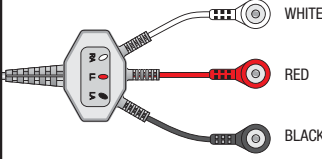

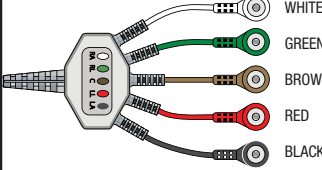
---

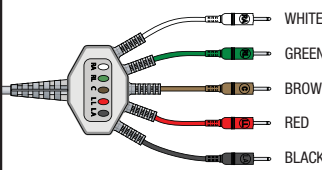
## FIXED PATIENT CABLES

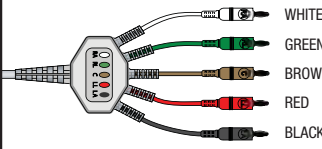
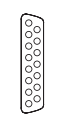
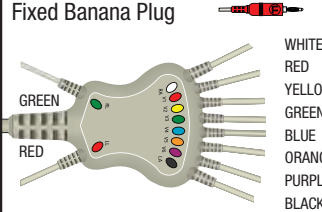









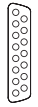

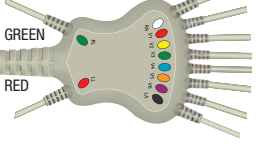

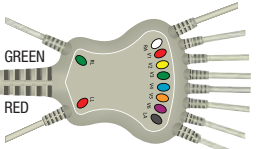
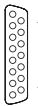
DESCRIPTION	EQUIPMENT END	PATIENT END	NOTES
<b>RPI Part #KCB002</b> <b>PATIENT CABLE - 3 LEAD FIXED SNAP</b> • Number of Leads: 3 • Length: ~11 ft.	6-Pin; 1K $\Omega$ Resistors Jumper E to C 	Fixed Snap 	
<b>RPI Part #KCB008</b> <b>PATIENT CABLE - 3 LEAD FIXED SNAP</b> • Number of Leads: 3 • Length: ~11 ft.	6-Pin Jumper E to B 	Fixed Snap 	
<b>RPI Part #KCB036</b> <b>OEM Part #11110-000029/3006218-02</b> <b>PATIENT CABLE - 3 LEAD FIXED SNAP</b> • Number of Leads: 3 • Length: ~10 ft. 	12-Pin Right Angle 	Fixed Snap 	
<b>RPI Part #KEB012</b> <b>PATIENT CABLE - 5 LEAD FIXED SNAP</b> • Number of Leads: 5 • Length: ~13 ft.	6-Pin 	Fixed Snap 	
<b>RPI Part #KEB014</b> Old RPI Part #BUC009 <b>PATIENT CABLE - 5 LEAD FIXED PIN</b> • Number of Leads: 5 • Length: ~8 ft.	5-Pin 	Fixed .125" Pin 	<ul style="list-style-type: none"> <li>• This cable replaces RPI Part #BUC009</li> <li>• Also available: Leadwire Adapter Kit (RPI Part #LAK001)</li> </ul>
<b>RPI Part #KEB030</b> Old RPI Part #HPC005 <b>PATIENT CABLE - 5 LEAD FIXED BANANA</b> • Number of Leads: 5 • Length: ~13 ft.	6-Pin 	Fixed Banana Plug 	<ul style="list-style-type: none"> <li>• This cable replaces RPI Part #HPC005</li> <li>• Also available: Leadwire Adapter Kit (RPI Part #LAK001)</li> </ul>
<b>RPI Part #KKB002</b> <b>PATIENT CABLE - 10 LEAD FIXED BANANA</b> • Number of Leads: 10 • Length: ~10 ft.	15-Pin D-Sub 	Fixed Banana Plug 	<ul style="list-style-type: none"> <li>• Also available: Leadwire Adapter Kit (RPI Part #LAK001)</li> </ul>

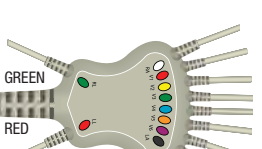
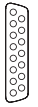
(continued on next page)

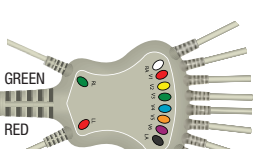
# General Biomedical Equipment

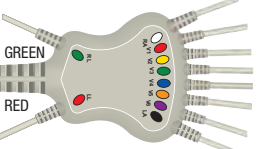

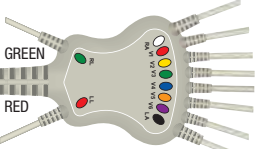
ECG, Monitoring & Defibrillators

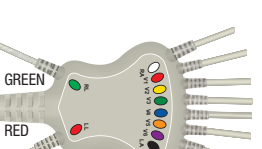
## FIXED PATIENT CABLES (Continued)









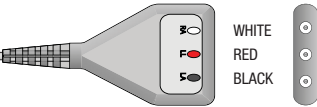

DESCRIPTION	EQUIPMENT END	PATIENT END	NOTES
<b>RPI Part #KKB003</b> <b>PATIENT CABLE - 10 LEAD FIXED BANANA</b> • Number of Leads: 10 • Length: ~10 ft.	15-Pin D-Sub 	Fixed Banana Plug  	• Also available: Leadwire Adapter Kit (RPI Part #LAK001)
<b>RPI Part #KKB006</b> <b>PATIENT CABLE - 10 LEAD FIXED BANANA</b> • Number of Leads: 10 • Length: ~10 ft.	15-Pin D-Sub; 20K $\Omega$ Resistors 	Fixed Banana Plug  	• Also available: Leadwire Adapter Kit (RPI Part #LAK001)
<b>RPI Part #KKB007</b> <b>PATIENT CABLE - 10 LEAD FIXED BANANA</b> • Number of Leads: 10 • Length: ~10 ft.	15-Pin D-Sub; 10K $\Omega$ Resistors 	Fixed Banana Plug  	• Also available: Leadwire Adapter Kit (RPI Part #LAK001)
<b>RPI Part #KKB008</b> <b>PATIENT CABLE - 10 LEAD FIXED BANANA</b> • Number of Leads: 10 • Length: ~10 ft.	15-Pin D-Sub; 10K $\Omega$ Resistors 	Fixed Banana Plug  	• Also available: Leadwire Adapter Kit (RPI Part #LAK001)
<b>RPI Part #KKB010</b> <b>OEM Part #60-00180-01/ 60-00184-01</b> <b>PATIENT CABLE - 10 LEAD FIXED PINCH</b> • Number of Leads: 10 • Length: ~18 ft.	12-Pin; 10K $\Omega$ Resistors 	Fixed Pinch  	
<b>RPI Part #KKB011</b> <b>OEM Part #60-00181-01/ 60-00185-01</b> <b>PATIENT CABLE - 10 LEAD FIXED SNAP</b> • Number of Leads: 10 • Length: ~18 ft.	12-Pin; 10K $\Omega$ Resistors 	Fixed Snap  	
<b>RPI Part #KKB012</b> <b>OEM Part #223 418 09</b> <b>PATIENT CABLE - 10 LEAD FIXED BANANA</b> • Number of Leads: 10 • Length: ~9 ft.	15-Pin D-Sub; 10K $\Omega$ Resistors 	Fixed Banana Plug  	• Also available: Leadwire Adapter Kit (RPI Part #LAK001)

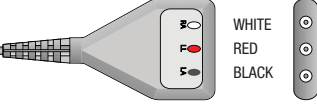

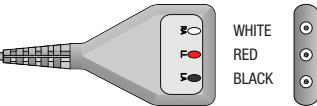
## FIXED PATIENT CABLES ACCESSORIES (FOR BANANA & PIN STYLES)

DESCRIPTION	ACCESSORY	DETAILS
<b>RPI Part #LAK001</b> <b>LEADWIRE ADAPTER KIT</b>	 <div style="display: flex; align-items: center; justify-content: center;"> <div style="text-align: center;">  </div> <div style="margin-left: 10px;"> <p>Includes 10 adapters individually labeled with leadwire identifiers</p> </div> </div>	<ul style="list-style-type: none"> <li>• Includes 10 adapters individually labeled with leadwire identifiers</li> <li>• Adapts banana plugs or pins to tab or snap electrodes</li> <li>• Widest contact area for superior trace quality</li> <li>• Flat, wide bodied design helps prevent twisting</li> <li>• Durable construction - built to last</li> </ul>

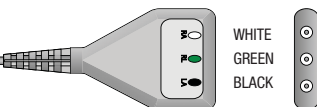
## DIN/UNSHIELDED PATIENT CABLES

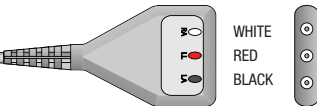









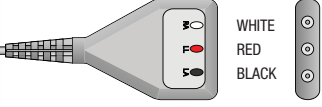

DESCRIPTION	EQUIPMENT END	PATIENT END	NOTES
<b>RPI Part #KCA001</b> <b>PATIENT CABLE - 3 LEAD DIN</b> • Number of Leads: 3 • Length: ~10 ft.	6-Pin; 1K $\Omega$ Resistors Jumper E to C 	Din/Unshielded .060" Pin (Safety) 	<b>Reusable Leadwire Sets</b> RPI Part #'s LKM002 & LKM005 <b>Disposable Leadwire Sets</b> RPI Part #'s LDM301 & LDM308 <b>Veterinary Leadwire Set</b> RPI Part #LVM701
<b>RPI Part #KCA004</b> <b>PATIENT CABLE - 3 LEAD DIN</b> • Number of Leads: 3 • Length: ~10 ft.	6-Pin; 1K $\Omega$ Resistors 	Din/Unshielded .060" Pin (Safety) 	<b>Reusable Leadwire Sets</b> RPI Part #'s LKM002 & LKM005 <b>Disposable Leadwire Sets</b> RPI Part #'s LDM301 & LDM308 <b>Veterinary Leadwire Set</b> RPI Part #LVM701
<b>RPI Part #KCA007</b> <b>PATIENT CABLE - 3 LEAD DIN</b> • Number of Leads: 3 • Length: ~10 ft.	6-Pin Jumper E to B 	Din/Unshielded .060" Pin (Safety) 	<b>Reusable Leadwire Sets</b> RPI Part #'s LKM002 & LKM005 <b>Disposable Leadwire Sets</b> RPI Part #'s LDM301 & LDM308 <b>Veterinary Leadwire Set</b> RPI Part #LVM701
<b>RPI Part #KCA010</b> <b>PATIENT CABLE - 3 LEAD DIN</b> • Number of Leads: 3 • Length: ~10 ft.	12-Pin; 1K $\Omega$ Resistors 	Din/Unshielded .060" Pin (Safety) 	<b>Reusable Leadwire Sets</b> RPI Part #'s LKM002 & LKM005 <b>Disposable Leadwire Sets</b> RPI Part #'s LDM301 & LDM308 <b>Veterinary Leadwire Set</b> RPI Part #LVM701
<b>RPI Part #KCA013</b> <b>PATIENT CABLE - 3 LEAD DIN</b> • Number of Leads: 3 • Length: ~10 ft.	5-Pin 	Din/Unshielded .060" Pin (Safety) 	<b>Reusable Leadwire Sets</b> RPI Part #'s LKM008 & LKM011 <b>Disposable Leadwire Sets</b> RPI Part #'s LDM302 & LDM309 <b>Veterinary Leadwire Set</b> RPI Part #LVM702
<b>RPI Part #KCA016</b> <b>PATIENT CABLE - 3 LEAD DIN</b> • Number of Leads: 3 • Length: ~10 ft.	6-Pin 	Din/Unshielded .060" Pin (Safety) 	<b>Reusable Leadwire Sets</b> RPI Part #'s LKM002 & LKM005 <b>Disposable Leadwire Sets</b> RPI Part #'s LDM301 & LDM308 <b>Veterinary Leadwire Set</b> RPI Part #LVM701

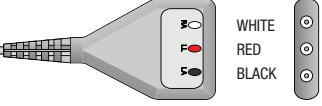
(continued on next page)

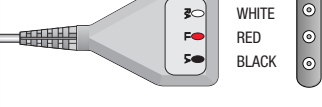
# General Biomedical Equipment

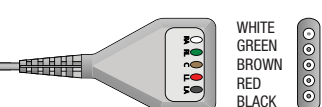
ECG, Monitoring & Defibrillators



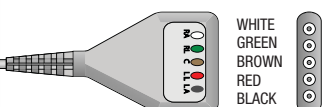









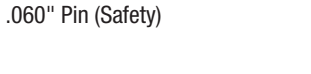

## DIN/UNSHIELDED PATIENT CABLES (Continued)

DESCRIPTION	EQUIPMENT END	PATIENT END	NOTES
<b>RPI Part #KCA019</b> <b>PATIENT CABLE - 3 LEAD DIN</b> • Number of Leads: 3 • Length: ~10 ft.	11-Pin; Jumper 5 to 6 with 120M $\Omega$ Resistor 	Din/Unshielded .060" Pin (Safety) 	Reusable Leadwire Sets RPI Part #'s LKM002 & LKM005 Disposable Leadwire Sets RPI Part #'s LDM301 & LDM308 Veterinary Leadwire Set RPI Part #LVM701
<b>RPI Part #KCA022</b> Old RPI Part #HPC004 <b>PATIENT CABLE - 3 LEAD DIN</b> • Number of Leads: 3 • Length: ~10 ft.	8-Pin; 1K $\Omega$ Resistors 	Din/Unshielded .060" Pin (Safety) 	Reusable Leadwire Sets RPI Part #'s LKM008 & LKM011 Disposable Leadwire Sets RPI Part #'s LDM302 & LDM309 Veterinary Leadwire Set RPI Part #LVM702
<b>RPI Part #KCA025</b> <b>PATIENT CABLE - 3 LEAD DIN</b> • Number of Leads: 3 • Length: ~10 ft.	8-Pin; 1K $\Omega$ Resistors 	Din/Unshielded .060" Pin (Safety) 	Reusable Leadwire Sets RPI Part #'s LKM002 & LKM005 Disposable Leadwire Sets RPI Part #'s LDM301 & LDM308 Veterinary Leadwire Set RPI Part #LVM701
<b>RPI Part #KCA035</b> OEM Part #11110-000029/ 3006218-02 <b>PATIENT CABLE - 3 LEAD DIN</b> • Number of Leads: 3 • Length: ~10 ft.	12-Pin Right Angle; 10K $\Omega$ Resistors 	Din/Unshielded .060" Pin (Safety) 	Reusable Leadwire Sets RPI Part #'s LKM002 & LKM005 Disposable Leadwire Sets RPI Part #'s LDM301 & LDM308 Veterinary Leadwire Set RPI Part #LVM701
<b>RPI Part #KEA001</b> <b>PATIENT CABLE - 5 LEAD DIN</b> • Number of Leads: 5 • Length: ~10 ft.	11-Pin 	Din/Unshielded .060" Pin (Safety) 	Reusable Leadwire Sets RPI Part #'s LKM026, LKM029 & LKM030 Disposable Leadwire Sets RPI Part #'s LDM303 & LDM310 Veterinary Leadwire Set RPI Part #LVM703
<b>RPI Part #KEA005</b> <b>PATIENT CABLE - 5 LEAD DIN</b> • Number of Leads: 5 • Length: ~10 ft.	12-Pin; 1K $\Omega$ Resistors 	Din/Unshielded .060" Pin (Safety) 	Reusable Leadwire Sets RPI Part #'s LKM026, LKM029 & LKM030 Disposable Leadwire Sets RPI Part #'s LDM303 & LDM310 Veterinary Leadwire Set RPI Part #LVM703
<b>RPI Part #KEA017</b> Old RPI Part #HPC006 <b>PATIENT CABLE - 5 LEAD DIN</b> • Number of Leads: 5 • Length: ~10 ft.	8-Pin; 1K $\Omega$ Resistors 	Din/Unshielded .060" Pin (Safety) 	Reusable Leadwire Sets RPI Part #'s LKM026, LKM029 & LKM030 Disposable Leadwire Sets RPI Part #'s LDM303 & LDM310 Veterinary Leadwire Set RPI Part #LVM703

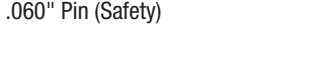

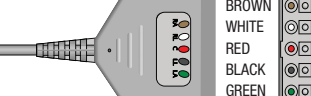

## DUAL/SHIELDED PATIENT CABLES



DESCRIPTION	EQUIPMENT END	PATIENT END	NOTES
<b>RPI Part #KCC003</b> <b>PATIENT CABLE - 3 LEAD DUAL</b> • Number of Leads: 3 • Length: ~10 ft.	6-Pin; 1K $\Omega$ Resistors Jumper E to C 	Dual/Shielded .060" Pin (Safety) 	<b>Reusable Leadwire Sets</b> RPI Part #'s LKM014 & LKM017 <b>Disposable Leadwire Sets</b> RPI Part #'s LDM305 & LDM312 <b>Veterinary Leadwire Set</b> RPI Part #LVM705
<b>RPI Part #KCC009</b> <b>PATIENT CABLE - 3 LEAD DUAL</b> • Number of Leads: 3 • Length: ~10 ft.	6-Pin; Jumper E to B 	Dual/Shielded .060" Pin (Safety) 	<b>Reusable Leadwire Sets</b> RPI Part #'s LKM014 & LKM017 <b>Disposable Leadwire Sets</b> RPI Part #'s LDM305 & LDM312 <b>Veterinary Leadwire Set</b> RPI Part #LVM705
<b>RPI Part #KCC012</b> <b>PATIENT CABLE - 3 LEAD DUAL</b> • Number of Leads: 3 • Length: ~10 ft.	12-Pin; 1K $\Omega$ Resistors 	Dual/Shielded .060" Pin (Safety) 	<b>Reusable Leadwire Sets</b> RPI Part #'s LKM014 & LKM017 <b>Disposable Leadwire Sets</b> RPI Part #'s LDM305 & LDM312 <b>Veterinary Leadwire Set</b> RPI Part #LVM705
<b>RPI Part #KCC021</b> <b>PATIENT CABLE - 3 LEAD DUAL</b> • Number of Leads: 3 • Length: ~10 ft.	11-Pin; Jumper 5 to 6 with 120M $\Omega$ Resistor 	Dual/Shielded .060" Pin (Safety) 	<b>Reusable Leadwire Sets</b> RPI Part #'s LKM014 & LKM017 <b>Disposable Leadwire Sets</b> RPI Part #'s LDM305 & LDM312 <b>Veterinary Leadwire Set</b> RPI Part #LVM705
<b>RPI Part #KCC034</b> <b>OEM Part #545302</b> <b>PATIENT CABLE - 3 LEAD DUAL</b> • Number of Leads: 3 • Length: ~10 ft.	10-Socket; 4.7K $\Omega$ Resistors 	Dual/Shielded .060" Pin (Safety) 	<b>Reusable Leadwire Sets</b> RPI Part #'s LKM014 & LKM017 <b>Disposable Leadwire Sets</b> RPI Part #'s LDM305 & LDM312 <b>Veterinary Leadwire Set</b> RPI Part #LVM705
<b>RPI Part #KEC003</b> <b>PATIENT CABLE - 5 LEAD DUAL</b> • Number of Leads: 5 • Length: ~10 ft.	11-Pin 	Dual/Shielded .060" Pin (Safety) 	<b>Reusable Leadwire Sets</b> RPI Part #'s LKM032 & LKM035 <b>Disposable Leadwire Sets</b> RPI Part #'s LDM307 & LDM314 <b>Veterinary Leadwire Set</b> RPI Part #LVM707
<b>RPI Part #KEC007</b> <b>PATIENT CABLE - 5 LEAD DUAL</b> • Number of Leads: 5 • Length: ~10 ft.	12-Pin; 1K $\Omega$ Resistors 	Dual/Shielded .060" Pin (Safety) 	<b>Reusable Leadwire Sets</b> RPI Part #'s LKM032 & LKM035 <b>Disposable Leadwire Sets</b> RPI Part #'s LDM307 & LDM314 <b>Veterinary Leadwire Set</b> RPI Part #LVM707
<b>RPI Part #KEC010</b> <b>PATIENT CABLE - 5 LEAD DUAL</b> • Number of Leads: 5 • Length: ~10 ft.	6-Pin; 1K $\Omega$ Resistors 	Dual/Shielded .060" Pin (Safety) 	<b>Reusable Leadwire Sets</b> RPI Part #'s LKM032 & LKM035 <b>Disposable Leadwire Sets</b> RPI Part #'s LDM307 & LDM314 <b>Veterinary Leadwire Set</b> RPI Part #LVM707

(continued on next page)

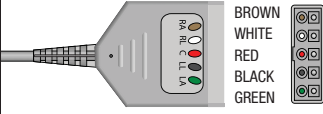

# General Biomedical Equipment

ECG, Monitoring & Defibrillators

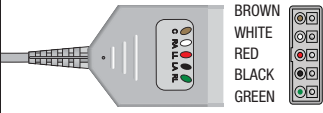
## DUAL/SHIELDED PATIENT CABLES (Continued)

DESCRIPTION	EQUIPMENT END	PATIENT END	NOTES
<b>RPI Part #KEC016</b> <b>PATIENT CABLE - 5 LEAD DUAL</b> • Number of Leads: 5 • Length: ~10 ft.	17-Pin; 1K $\Omega$ Resistors Jumper 1 to 3 with 16K $\Omega$ Resistor 	Dual/Shielded .060" Pin (Safety) 	<b>Reusable Leadwire Sets</b> RPI Part #'s LKM032 & LKM035 <b>Disposable Leadwire Sets</b> RPI Part #'s LDM307 & LDM314 <b>Veterinary Leadwire Set</b> RPI Part #LVM707
<b>RPI Part #KEC022</b> <b>OEM Part #545303</b> <b>PATIENT CABLE - 5 LEAD DUAL</b> • Number of Leads: 5 • Length: ~10 ft.	10-Socket; 4.7K $\Omega$ Resistors 	Dual/Shielded .060" Pin (Safety) 	<b>Reusable Leadwire Sets</b> RPI Part #'s LKM032 & LKM035 <b>Disposable Leadwire Sets</b> RPI Part #'s LDM307 & LDM314 <b>Veterinary Leadwire Set</b> RPI Part #LVM707



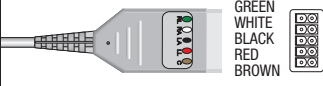

## DUAL/SHIELDED PATIENT CABLES TO FIT GE MULTI-LINK®

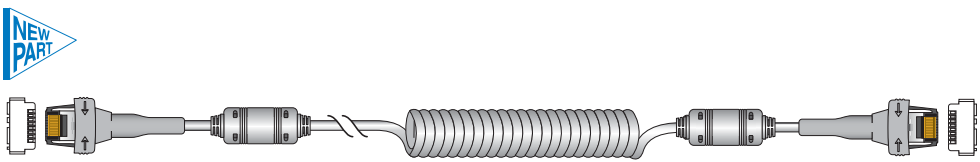
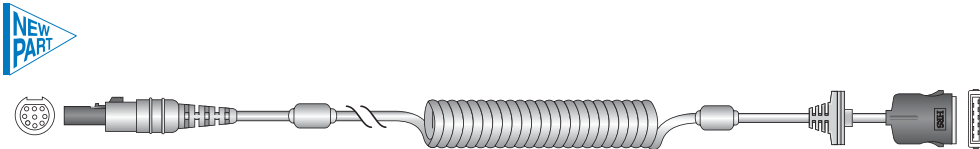
DESCRIPTION	EQUIPMENT END	PATIENT END	NOTES
<b>RPI Part #KCD033</b> <b>OEM Part #1554AA0</b> <b>PATIENT CABLE - 3 LEAD MULTI-LINK</b> • Number of Leads: 3 • Length: ~10 ft.	12-Pin 	Dual/Shielded; Compatible with GE Multi-Link® 	<b>Reusable Leadwire Sets</b> RPI Part #'s LKM052 & LKM053
<b>RPI Part #KED021</b> <b>OEM Part #2017003-001/412931-001</b> <b>PATIENT CABLE - 5 LEAD MULTI-LINK</b> • Number of Leads: 5 • Length: ~10 ft.	11-Pin 	Dual/Shielded; Compatible with GE Multi-Link® 	<b>Reusable Leadwire Sets</b> RPI Part #'s LKM052, LKM053, LKM054, LKM055, LKM056 & LKM057



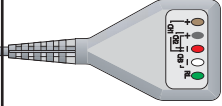

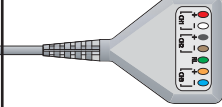
## CABLES TO FIT GE ACQUISITION MODULES

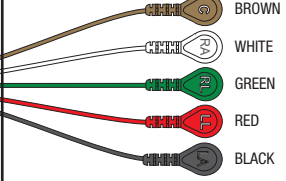
DESCRIPTION	
<b>RPI Part #GEC020</b> <b>OEM Part #700044-201/700044-202/700044-204</b> <b>ACQUISITION MODULE CABLE</b> • Length: ~17 ft. overall length Fits: AM4 Acquisition Module and AM5 Acquisition Module	
<b>RPI Part #GEC021</b> <b>OEM Part #2016560-002/2016560-003/700657-002/700657-003</b> <b>ACQUISITION MODULE CABLE</b> • Length: ~17 ft. overall length Fits: CAM 14 Acquisition Module	

## HOLTER CABLES

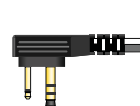
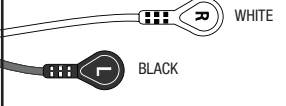
DESCRIPTION	EQUIPMENT END	PATIENT END	NOTES
<b>RPI Part #KEA004</b> <b>HOLTER CABLE - 5 LEAD 3 CHANNEL</b> • Number of Leads: 5 • Length: ~30"	7-Socket; Jumper 1 to 5 and 2 to 6 	Din/Unshielded .060" Pin (Safety)  BROWN BLACK RED WHITE GREEN	<b>Reusable Leadwire Sets</b> RPI Part #'s LKM026, LKM029 & LKM030 <b>Disposable Leadwire Sets</b> RPI Part #'s LDM303 & LDM310 <b>Veterinary Leadwire Set</b> RPI Part #LVM703
<b>RPI Part #KGA001</b> <b>HOLTER CABLE - 7 LEAD 3 CHANNEL</b> • Number of Leads: 7 • Length: ~40"	7-Socket 	Din/Unshielded .060" Pin (Safety)  RED WHITE BLACK BROWN GREEN ORANGE BLUE	<b>Reusable Leadwire Sets</b> RPI Part #'s LKM038 & LKM041 <b>Disposable Leadwire Sets</b> RPI Part #'s LDM304 & LDM311 <b>Veterinary Leadwire Set</b> RPI Part #LVM704
<b>RPI Part #KEB020</b> <b>OEM Part #3-370-0001</b> <b>HOLTER CABLE - 5 LEAD FIXED SNAP</b> • Number of Leads: 5 • Length: ~43" 	7-Socket 	Fixed Snap  BROWN WHITE GREEN RED BLACK	

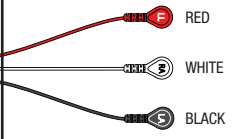
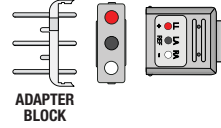
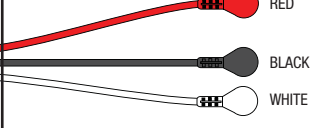
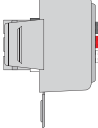
## TELEMETRY CABLES





DESCRIPTION	EQUIPMENT END	PATIENT END	NOTES
<b>RPI Part #KBB001</b> <b>TELEMETRY CABLE - 2 LEAD SNAP</b> • Number of Leads: 2 • Length: ~32"	Dual Phono Plug 90-Deg 	Fixed Snap  WHITE BLACK	
<b>RPI Part #KCB028</b> <b>TELEMETRY CABLE - 3 LEAD SNAP</b> • Number of Leads: 3 • Length: ~27"	7-Socket; Jumper 1 to 5 	Fixed Snap  RED WHITE BLACK	• Also available: 3 Lead Organizer (RPI Part #LAR004)
<b>RPI Part #KCB029</b> <b>Old RPI Part #HPC008</b> <b>TELEMETRY CABLE - 3 LEAD SNAP</b> • Number of Leads: 3 • Length: ~30"	3-Lead Safety Block  ADAPTER BLOCK	Fixed Snap  RED BLACK WHITE	• This cable replaces RPI Part #HPC008 • Includes Adapter Block • Also available: 3 Lead Organizer (RPI Part #LAR004)
<b>RPI Part #KCB031</b> <b>TELEMETRY CABLE - 3 LEAD SNAP</b> • Number of Leads: 3 • Length: ~30"	Dual/Shielded 	Fixed Snap  BLACK RED WHITE	• Includes: 3 Lead Organizer (RPI Part #LAR004)

(continued on next page)

# General Biomedical Equipment

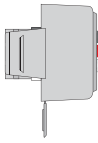
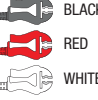
ECG, Monitoring & Defibrillators

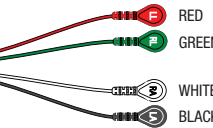
## TELEMETRY CABLES *(Continued)*

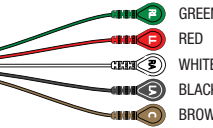
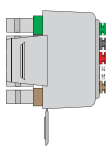
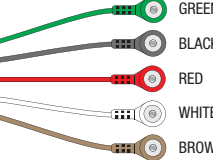
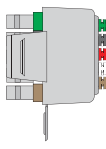
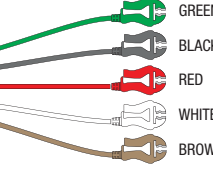
DESCRIPTION	EQUIPMENT END	PATIENT END	NOTES
<b>RPI Part #KCB032</b> <b>TELEMETRY CABLE - 3 LEAD PINCH</b> • Number of Leads: 3 • Length: ~30"	Dual/Shielded 	Fixed Pinch 	• Includes: 3 Lead Organizer (RPI Part #LAR004)
<b>RPI Part #KDB002</b> <b>TELEMETRY CABLE - 4 LEAD SNAP</b> • Number of Leads: 4 • Length: ~27"	7-Socket 	Fixed Snap 	• Also available: 5 Lead Organizer (RPI Part #LAR005)
<b>RPI Part #KEB015</b> <b>TELEMETRY CABLE - 5 LEAD SNAP</b> • Number of Leads: 5 • Length: ~24"	7-Socket 	Fixed Snap 	• Also available: 5 Lead Organizer (RPI Part #LAR005)
<b>RPI Part #KEB018</b> <b>TELEMETRY CABLE - 5 LEAD SNAP</b> • Number of Leads: 5 • Length: ~30"	Dual/Shielded 	Fixed Snap 	• Includes: 5 Lead Organizer (RPI Part #LAR005)
<b>RPI Part #KEB019</b> <b>TELEMETRY CABLE - 5 LEAD PINCH</b> • Number of Leads: 5 • Length: ~30"	Dual/Shielded 	Fixed Pinch 	• Includes: 5 Lead Organizer (RPI Part #LAR005)

NOTES: \_\_\_\_\_

\_\_\_\_\_

\_\_\_\_\_

\_\_\_\_\_

\_\_\_\_\_

\_\_\_\_\_

\_\_\_\_\_

## REUSABLE: BONDED LEADWIRE SETS TO FIT GE MULTI-LINK®

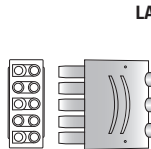
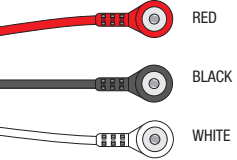
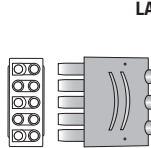
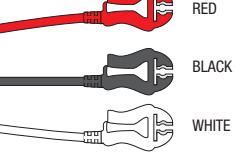
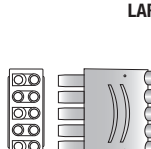
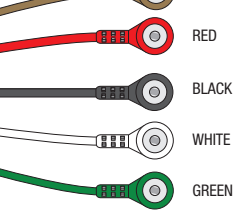
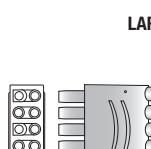
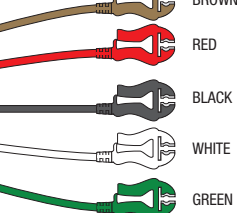
DESCRIPTION	EQUIPMENT END	PATIENT END
<p><b>RPI Part #LKM052</b> <b>OEM Part #411203-001</b></p> <p><b>3 LEADWIRE SET - 30" MULTI-LINK/SNAP</b></p> <ul style="list-style-type: none"> <li>Number of Leads: 3 Bonded leadwires</li> <li>Length: ~30"</li> <li>Includes: 3 Lead Organizer (RPI Part #LAR004)</li> </ul> <p><b>Also available:</b></p> <ul style="list-style-type: none"> <li>Bonded Leadwire Sets (RPI Part #'s LKM053, LKM054 &amp; LKM055) &amp; Combined Leadwire Sets (RPI Part #'s LKM056 &amp; LKM057)</li> </ul> <p><b>Fits:</b> GE Multi-Link® Cable, Patient Cable - 5 Lead Multi-Link® (RPI Part #KED021) and Patient Cable - 3 Lead Multi-Link® (RPI Part #KCD033)</p>	<p>Dual/Shielded; Jumper 1 to 5 with 130M <math>\Omega</math> Resistor; Compatible with GE Multi-Link®</p> 	<p>Snap</p> 
<p><b>RPI Part #LKM053</b> <b>OEM Part #412682-001</b></p> <p><b>3 LEADWIRE SET - 30" MULTI-LINK/PINCH</b></p> <ul style="list-style-type: none"> <li>Number of Leads: 3 Bonded leadwires</li> <li>Length: ~30"</li> <li>Includes: 3 Lead Organizer (RPI Part #LAR004)</li> </ul> <p><b>Also available:</b></p> <ul style="list-style-type: none"> <li>Bonded Leadwire Sets (RPI Part #'s LKM052, LKM054 &amp; LKM055) &amp; Combined Leadwire Sets (RPI Part #'s LKM056 &amp; LKM057)</li> </ul> <p><b>Fits:</b> GE Multi-Link® Cable, Patient Cable - 5 Lead Multi-Link® (RPI Part #KED021) and Patient Cable - 3 Lead Multi-Link® (RPI Part #KCD033)</p>	<p>Dual/Shielded; Jumper 1 to 5 with 130M <math>\Omega</math> Resistor; Compatible with GE Multi-Link®</p> 	<p>Pinch</p> 
<p><b>RPI Part #LKM054</b> <b>OEM Part #411202-001</b></p> <p><b>5 LEADWIRE SET - 30" MULTI-LINK/SNAP</b></p> <ul style="list-style-type: none"> <li>Number of Leads: 5 Bonded leadwires</li> <li>Length: ~30"</li> <li>Includes: 5 Lead Organizer (RPI Part #LAR005)</li> </ul> <p><b>Also available:</b></p> <ul style="list-style-type: none"> <li>Bonded Leadwire Sets (RPI Part #'s LKM052, LKM053 &amp; LKM055) &amp; Combined Leadwire Sets (RPI Part #'s LKM056 &amp; LKM057)</li> </ul> <p><b>Fits:</b> GE Multi-Link® Cable and Patient Cable - 5 Lead Multi-Link® (RPI Part #KED021)</p>	<p>Dual/Shielded; Compatible with GE Multi-Link®</p> 	<p>Snap</p> 
<p><b>RPI Part #LKM055</b> <b>OEM Part #412681-001</b></p> <p><b>5 LEADWIRE SET - 30" MULTI-LINK/PINCH</b></p> <ul style="list-style-type: none"> <li>Number of Leads: 5 Bonded leadwires</li> <li>Length: ~30"</li> <li>Includes: 5 Lead Organizer (RPI Part #LAR005)</li> </ul> <p><b>Also available:</b></p> <ul style="list-style-type: none"> <li>Bonded Leadwire Sets (RPI Part #'s LKM052, LKM053 &amp; LKM054) &amp; Combined Leadwire Sets (RPI Part #'s LKM056 &amp; LKM057)</li> </ul> <p><b>Fits:</b> GE Multi-Link® Cable and Patient Cable - 5 Lead Multi-Link® (RPI Part #KED021)</p>	<p>Dual/Shielded; Compatible with GE Multi-Link®</p> 	<p>Pinch</p> 

# General Biomedical Equipment

ECG, Monitoring & Defibrillators

## REUSABLE: COMBINED LEADWIRE SETS TO FIT GE MULTI-LINK®

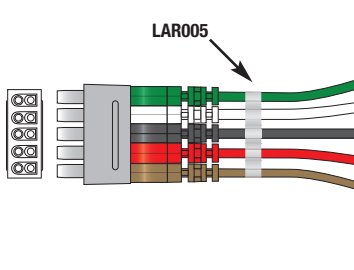
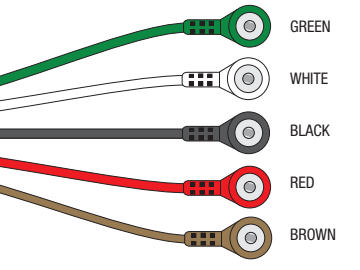
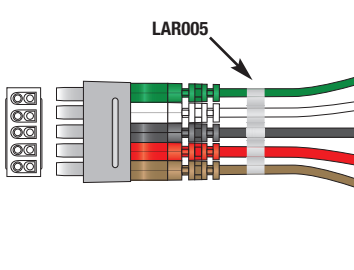
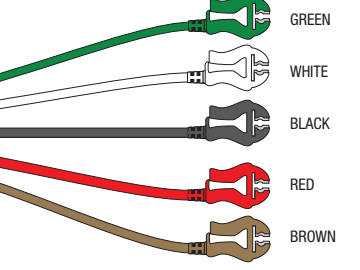
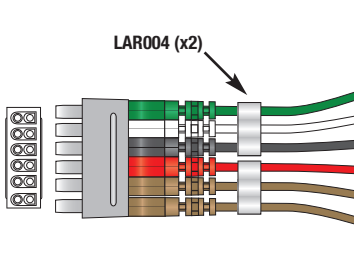
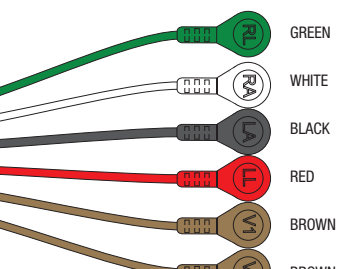
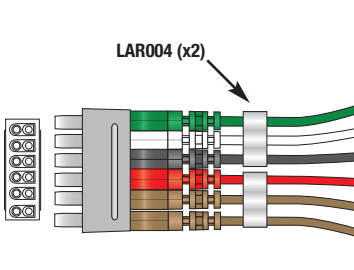
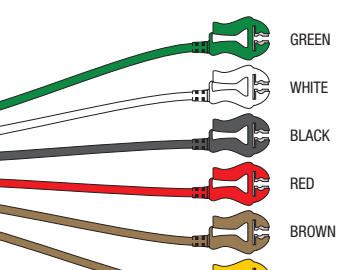
DESCRIPTION	EQUIPMENT END	PATIENT END
<p><b>RPI Part #LKM056</b>  <b>OEM Part #411200-001</b></p> <p><b>5 LEADWIRE SET - 30" MULTI-LINK/SNAP</b></p> <ul style="list-style-type: none"> <li>Number of Leads: 5 individual leadwires with combiner</li> <li>Length: ~30"</li> <li>Includes: 5 Lead Organizer (RPI Part #LAR005) and combiner</li> </ul> <p><b>Also available:</b></p> <ul style="list-style-type: none"> <li>Bonded Leadwire Sets (RPI Part #'s LKM052, LKM053, LKM054 &amp; LKM055) &amp; Combined Leadwire Set (RPI Part #LKM057)</li> </ul> <p><b>Fits:</b> GE Multi-Link® Cable and Patient Cable - 5 Lead Multi-Link® (RPI Part #KED021)</p>	<p>Dual/Shielded; Compatible with GE Multi-Link®</p> 	<p>Snap</p> 
<p><b>RPI Part #LKM057</b>  <b>OEM Part #414556-001</b></p> <p><b>5 LEADWIRE SET - 30" MULTI-LINK/PINCH</b></p> <ul style="list-style-type: none"> <li>Number of Leads: 5 individual leadwires with combiner</li> <li>Length: ~30"</li> <li>Includes: 5 Lead Organizer (RPI Part #LAR005) and combiner</li> </ul> <p><b>Also available:</b></p> <ul style="list-style-type: none"> <li>Bonded Leadwire Sets (RPI Part #'s LKM052, LKM053, LKM054 &amp; LKM055) &amp; Combined Leadwire Set (RPI Part #LKM056)</li> </ul> <p><b>Fits:</b> GE Multi-Link® Cable and Patient Cable - 5 Lead Multi-Link® (RPI Part #KED021)</p>	<p>Dual/Shielded; Compatible with GE Multi-Link®</p> 	<p>Pinch</p> 
<p><b>RPI Part #LKM058</b>  <b>OEM Part #421930-001</b></p> <p><b>6 LEADWIRE SET - 30" MULTI-LINK/SNAP</b></p> <ul style="list-style-type: none"> <li>Number of Leads: 6 individual leadwires with combiner</li> <li>Length: ~30"</li> <li>Includes: (2) 3 Lead Organizer (RPI Part #LAR004) and 6 lead combiner</li> </ul> <p><b>Also available:</b></p> <ul style="list-style-type: none"> <li>Combined Leadwire Set (RPI Part #LKM059)</li> </ul>	<p>Dual/Shielded; Compatible with GE Multi-Link®</p> 	<p>Snap</p> 
<p><b>RPI Part #LKM059</b>  <b>OEM Part #421932-001</b></p> <p><b>6 LEADWIRE SET - 30" MULTI-LINK/PINCH</b></p> <ul style="list-style-type: none"> <li>Number of Leads: 6 individual leadwires with combiner</li> <li>Length: ~30"</li> <li>Includes: (2) 3 Lead Organizer (RPI Part #LAR004) and 6 lead combiner</li> </ul> <p><b>Also available:</b></p> <ul style="list-style-type: none"> <li>Combined Leadwire Set (RPI Part #LKM058)</li> </ul>	<p>Dual/Shielded; Compatible with GE Multi-Link®</p> 	<p>Pinch</p> 



## REUSABLE: LEADWIRE SETS TO FIT GE MULTI-LINK®







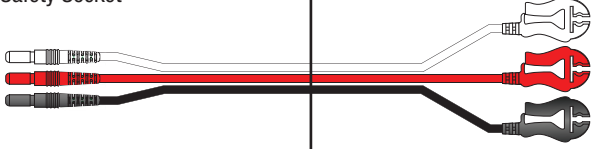

DESCRIPTION	EQUIPMENT END	PATIENT END
<p><b>RPI Part #LKM049</b> <b>OEM Part #420101-002</b></p> <p><b>10 LEADWIRE SET - CAM 14/BANANA</b></p> <ul style="list-style-type: none"> <li>• Number of Leads: 10</li> <li>• Length: ~27": Red (V1), Yellow (V2), Green (V3), Blue (V4), Orange (V5), Violet (V6); and, ~37": Green (RL), White (RA), Black (LA) &amp; Red (LL)</li> <li>• Includes: (2) 5 Lead Organizer (RPI Part #LAR005)</li> </ul> <p><b>Also available:</b></p> <ul style="list-style-type: none"> <li>• 10 Leadwire Set - CAM 14/Pinch (RPI Part #LKM050) &amp;</li> <li>• 10 Leadwire Set - CAM 14/Snap (RPI Part #LKM051)</li> </ul> <p><b>Fits:</b> CAM 14 Module</p>	<p>Dual/Shielded; Compatible with GE Multi-Link®</p>	<p>Banana Plug</p>
<p><b>RPI Part #LKM050</b> <b>OEM Part #420101-002</b></p> <p><b>10 LEADWIRE SET - CAM 14/PINCH</b></p> <ul style="list-style-type: none"> <li>• Number of Leads: 10</li> <li>• Length: ~27": Red (V1), Yellow (V2), Green (V3), Blue (V4), Orange (V5), Violet (V6); and, ~37": Green (RL), White (RA), Black (LA) &amp; Red (LL)</li> <li>• Includes: (2) 5 Lead Organizer (RPI Part #LAR005)</li> </ul> <p><b>Also available:</b></p> <ul style="list-style-type: none"> <li>• 10 Leadwire Set - CAM 14/Banana (RPI Part #LKM049) &amp;</li> <li>• 10 Leadwire Set - CAM 14/Snap (RPI Part #LKM051)</li> </ul> <p><b>Fits:</b> CAM 14 Module</p>	<p>Dual/Shielded; Compatible with GE Multi-Link®</p>	<p>Pinch</p>
<p><b>RPI Part #LKM051</b> <b>OEM Part #420101-002</b></p> <p><b>10 LEADWIRE SET - CAM 14/SNAP</b></p> <ul style="list-style-type: none"> <li>• Number of Leads: 10</li> <li>• Length: ~27": Red (V1), Yellow (V2), Green (V3), Blue (V4), Orange (V5), Violet (V6); and, ~37": Green (RL), White (RA), Black (LA) &amp; Red (LL)</li> <li>• Includes: (2) 5 Lead Organizer (RPI Part #LAR005)</li> </ul> <p><b>Also available:</b></p> <ul style="list-style-type: none"> <li>• 10 Leadwire Set - CAM 14/Banana (RPI Part #LKM049) &amp;</li> <li>• 10 Leadwire Set - CAM 14/Pinch (RPI Part #LKM050)</li> </ul> <p><b>Fits:</b> CAM 14 Module</p>	<p>Dual/Shielded; Compatible with GE Multi-Link®</p>	<p>Snap</p>

# General Biomedical Equipment

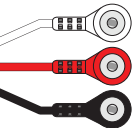
ECG, Monitoring & Defibrillators

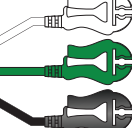
## REUSABLE: DIN/UNSHIELDED LEADWIRE SETS

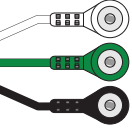
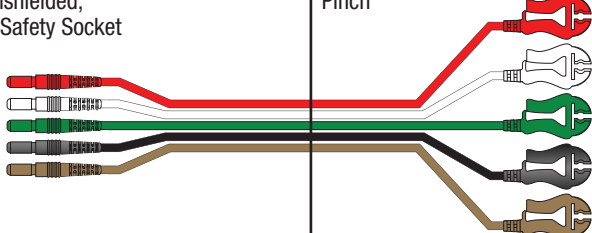
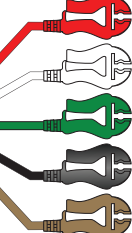
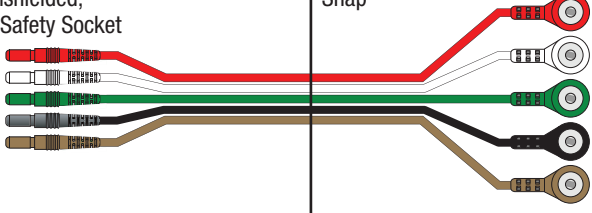
Accessories Also Available

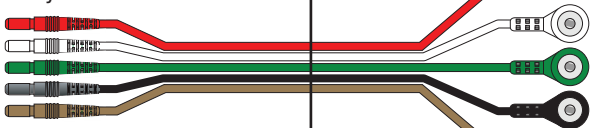
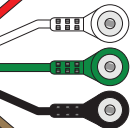
DESCRIPTION	EQUIPMENT END	PATIENT END
<p><b>RPI Part #LKM002</b>  <b>3 LEADWIRE SET - 24" DIN/PINCH</b>                      • Number of Leads: 3                      • Length: 24"  <b>Also available:</b>                      • Disposable Leadwire Set (RPI Part #LDM308) &amp; 3 Lead Organizer (RPI Part #LAR004)</p>	<p>Din/Unshielded;                      .060" Safety Socket</p> 	<p>Pinch</p>  <p>WHITE RED BLACK</p>
<p><b>RPI Part #LKM005</b>  <b>3 LEADWIRE SET - 24" DIN/SNAP</b>                      • Number of Leads: 3                      • Length: 24"  <b>Also available:</b>                      • Disposable Leadwire Set (RPI Part #LDM301) &amp; 3 Lead Organizer (RPI Part #LAR004)</p>	<p>Din/Unshielded;                      .060" Safety Socket</p> 	<p>Snap</p>  <p>WHITE RED BLACK</p>
<p><b>RPI Part #LKM008</b>  <b>3 LEADWIRE SET - 24" DIN/PINCH</b>                      • Number of Leads: 3                      • Length: 24"  <b>Also available:</b>                      • Disposable Leadwire Set (RPI Part #LDM309) &amp; 3 Lead Organizer (RPI Part #LAR004)</p>	<p>Din/Unshielded;                      .060" Safety Socket</p> 	<p>Pinch</p>  <p>WHITE GREEN BLACK</p>
<p><b>RPI Part #LKM011</b>                      Old RPI Part #HPC003  <b>3 LEADWIRE SET - 24" DIN/SNAP</b>                      • Number of Leads: 3                      • Length: 24"  <b>Also available:</b>                      • Disposable Leadwire Set (RPI Part #LDM302) &amp; 3 Lead Organizer (RPI Part #LAR004)</p>	<p>Din/Unshielded;                      .060" Safety Socket</p> 	<p>Snap</p>  <p>WHITE GREEN BLACK</p>
<p><b>RPI Part #LKM026</b>  <b>5 LEADWIRE SET - 24" DIN/PINCH</b>                      • Number of Leads: 5                      • Length: 24"  <b>Also available:</b>                      • Disposable Leadwire Set (RPI Part #LDM310) &amp; 5 Lead Organizer (RPI Part #LAR005)</p>	<p>Din/Unshielded;                      .060" Safety Socket</p> 	<p>Pinch</p>  <p>RED WHITE GREEN BLACK BROWN</p>
<p><b>RPI Part #LKM029</b>  <b>5 LEADWIRE SET - 24" DIN/SNAP</b>                      • Number of Leads: 5                      • Length: 24"  <b>Also available:</b>                      • 24" Disposable Leadwire Set (RPI Part #LDM303) &amp; 5 Lead Organizer (RPI Part #LAR005)</p>	<p>Din/Unshielded;                      .060" Safety Socket</p> 	<p>Snap</p>  <p>RED WHITE GREEN BLACK BROWN</p>
<p><b>RPI Part #LKM030</b>                      Old RPI Part #HPC007  <b>5 LEADWIRE SET - 40" DIN/SNAP</b>                      • Number of Leads: 5                      • Length: 40"  <b>Also available:</b>                      • 24" Disposable Leadwire Set (RPI Part #LDM303) &amp; 5 Lead Organizer (RPI Part #LAR005)</p>	<p>Din/Unshielded;                      .060" Safety Socket</p> 	<p>Snap</p>  <p>RED WHITE GREEN BLACK BROWN</p>

(continued on next page)



Accessories Also Available

## REUSABLE: DIN/UNSHIELDED LEADWIRE SETS (Continued)

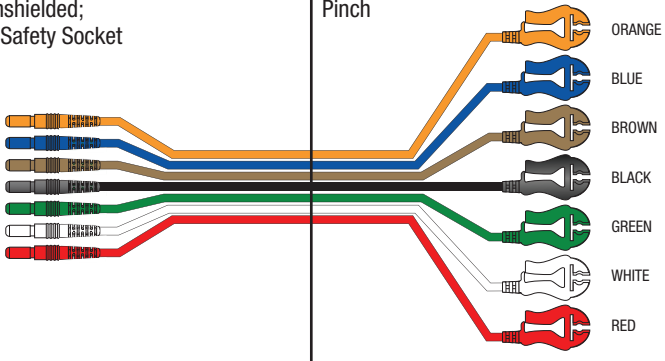
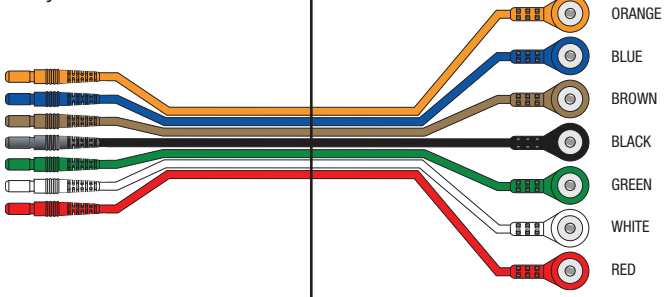
DESCRIPTION	EQUIPMENT END	PATIENT END
<b>RPI Part #LKM038</b> <b>7 LEADWIRE SET - 24" DIN/PINCH</b> • Number of Leads: 7 • Length: 24" <b>Also available:</b> • Disposable Leadwire Set (RPI Part #LDM311), 3 Lead Organizer (RPI Part #LAR004) & 5 Lead Organizer (RPI Part #LAR005)	Din/Unshielded; .060" Safety Socket	Pinch 
<b>RPI Part #LKM041</b> <b>7 LEADWIRE SET - 24" DIN/SNAP</b> • Number of Leads: 7 • Length: 24" <b>Also available:</b> • Disposable Leadwire Set (RPI Part #LDM304), 3 Lead Organizer (RPI Part #LAR004) & 5 Lead Organizer (RPI Part #LAR005)	Din/Unshielded; .060" Safety Socket	Snap 



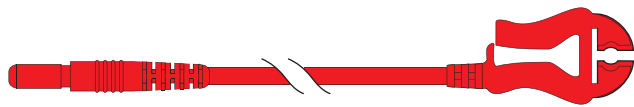



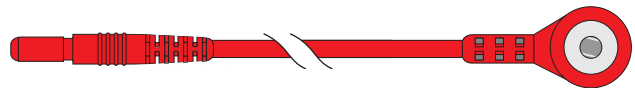





## REUSABLE: DIN/UNSHIELDED INDIVIDUAL LEADWIRES



- Equipment End: Din/Unshielded, .060" Safety Socket
- Patient End: Pinch
- Length: 24"



- Equipment End: Din/Unshielded, .060" Safety Socket
- Patient End: Snap
- Length: 24"

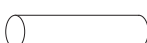
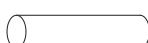





DESCRIPTION	LEADWIRE COLOR	DESCRIPTION	LEADWIRE COLOR
RPI Part #LPB002 LEADWIRE BLACK 24" DIN/PINCH	Black 	RPI Part #LSB002 LEADWIRE BLACK 24" DIN/SNAP	Black 
RPI Part #LPE002 LEADWIRE ORANGE 24" DIN/PINCH	Orange 	RPI Part #LSE002 LEADWIRE ORANGE 24" DIN/SNAP	Orange 
RPI Part #LPG002 LEADWIRE GREEN 24" DIN/PINCH	Green 	RPI Part #LSG002 LEADWIRE GREEN 24" DIN/SNAP	Green 
RPI Part #LPN002 LEADWIRE BROWN 24" DIN/PINCH	Brown 	RPI Part #LSN002 LEADWIRE BROWN 24" DIN/SNAP	Brown 
RPI Part #LPR002 LEADWIRE RED 24" DIN/PINCH	Red 	RPI Part #LSR002 LEADWIRE RED 24" DIN/SNAP	Red 
RPI Part #LPU002 LEADWIRE BLUE 24" DIN/PINCH	Blue 	RPI Part #LSU002 LEADWIRE BLUE 24" DIN/SNAP	Blue 
RPI Part #LPW002 LEADWIRE WHITE 24" DIN/PINCH	White 	RPI Part #LSW002 LEADWIRE WHITE 24" DIN/SNAP	White 

Depending on equipment model, these leadwires are also available as sets – see *REUSABLE: DIN/UNSHIELDED LEADWIRE SETS* on previous page.

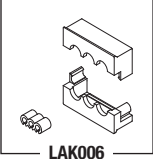
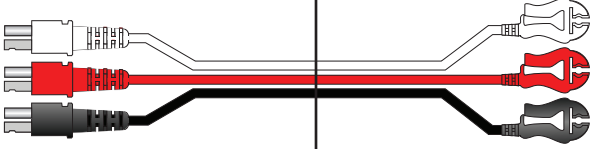
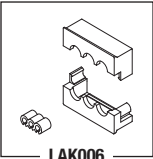
# General Biomedical Equipment

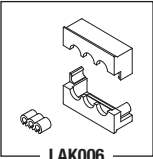
ECG, Monitoring & Defibrillators

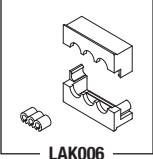
## REUSABLE: DUAL/SHIELDED LEADWIRE SETS

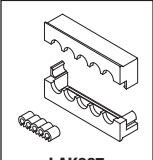
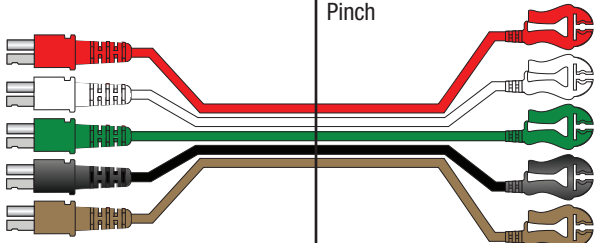
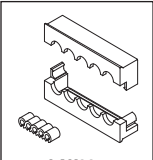
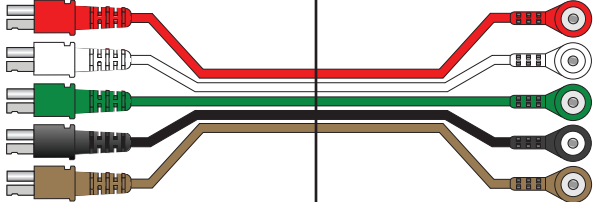
DESCRIPTION	EQUIPMENT END	PATIENT END
<p><b>RPI Part #LKM014</b></p> <p><b>3 LEADWIRE SET - 40" DUAL/PINCH</b></p> <ul style="list-style-type: none"> <li>• Number of Leads: 3</li> <li>• Length: 40"</li> <li>• Includes: 3 Lead Shielded Accessory Kit (RPI Part #LAK006)</li> </ul> <p><b>Also available:</b></p> <ul style="list-style-type: none"> <li>• Disposable Leadwire Set (RPI Part #LDM312)</li> </ul>	<p>Dual/Shielded</p>  <p>LAK006</p>	<p>Pinch</p>  <p>WHITE RED BLACK</p>
<p><b>RPI Part #LKM017</b></p> <p><b>3 LEADWIRE SET - 40" DUAL/SNAP</b></p> <ul style="list-style-type: none"> <li>• Number of Leads: 3</li> <li>• Length: 40"</li> <li>• Includes: 3 Lead Shielded Accessory Kit (RPI Part #LAK006)</li> </ul> <p><b>Also available:</b></p> <ul style="list-style-type: none"> <li>• Disposable Leadwire Set (RPI Part #LDM305)</li> </ul>	<p>Dual/Shielded</p>  <p>LAK006</p>	<p>Snap</p>  <p>WHITE RED BLACK</p>
<p><b>RPI Part #LKM020</b></p> <p><b>3 LEADWIRE SET - 40" DUAL/PINCH</b></p> <ul style="list-style-type: none"> <li>• Number of Leads: 3</li> <li>• Length: 40"</li> <li>• Includes: 3 Lead Shielded Accessory Kit (RPI Part #LAK006)</li> </ul> <p><b>Also available:</b></p> <ul style="list-style-type: none"> <li>• Disposable Leadwire Set (RPI Part #LDM313)</li> </ul>	<p>Dual/Shielded</p>  <p>LAK006</p>	<p>Pinch</p>  <p>WHITE GREEN BLACK</p>
<p><b>RPI Part #LKM023</b></p> <p><b>3 LEADWIRE SET - 40" DUAL/SNAP</b></p> <ul style="list-style-type: none"> <li>• Number of Leads: 3</li> <li>• Length: 40"</li> <li>• Includes: 3 Lead Shielded Accessory Kit (RPI Part #LAK006)</li> </ul> <p><b>Also available:</b></p> <ul style="list-style-type: none"> <li>• Disposable Leadwire Set (RPI Part #LDM306)</li> </ul>	<p>Dual/Shielded</p>  <p>LAK006</p>	<p>Snap</p>  <p>WHITE GREEN BLACK</p>
<p><b>RPI Part #LKM032</b></p> <p><b>5 LEADWIRE SET - 40" DUAL/PINCH</b></p> <ul style="list-style-type: none"> <li>• Number of Leads: 5</li> <li>• Length: 40"</li> <li>• Includes: 5 Lead Shielded Accessory Kit (RPI Part #LAK007)</li> </ul> <p><b>Also available:</b></p> <ul style="list-style-type: none"> <li>• Disposable Leadwire Set (RPI Part #LDM314)</li> </ul>	<p>Dual/Shielded</p>  <p>LAK007</p>	<p>Pinch</p>  <p>RED WHITE GREEN BLACK BROWN</p>
<p><b>RPI Part #LKM035</b></p> <p><b>5 LEADWIRE SET - 40" DUAL/SNAP</b></p> <ul style="list-style-type: none"> <li>• Number of Leads: 5</li> <li>• Length: 40"</li> <li>• Includes: 5 Lead Shielded Accessory Kit (RPI Part #LAK007)</li> </ul> <p><b>Also available:</b></p> <ul style="list-style-type: none"> <li>• Disposable Leadwire Set (RPI Part #LDM307)</li> </ul>	<p>Dual/Shielded</p>  <p>LAK007</p>	<p>Snap</p>  <p>RED WHITE GREEN BLACK BROWN</p>

## REUSABLE: DUAL/SHIELDED INDIVIDUAL LEADWIRES

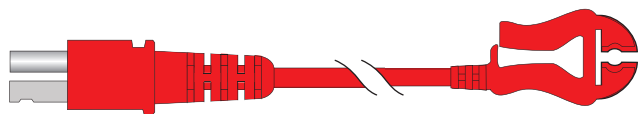





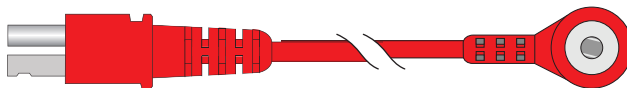





- Equipment End: Dual/Shielded
- Length: 40"

- Patient End: Pinch



- Equipment End: Dual/Shielded
- Length: 40"

- Patient End: Snap

DESCRIPTION	LEADWIRE COLOR	DESCRIPTION	LEADWIRE COLOR
RPI Part #LPB005 LEADWIRE BLACK 40" DUAL/PINCH	Black 	RPI Part #LSB005 LEADWIRE BLACK 40" DUAL/SNAP	Black 
RPI Part #LPG005 LEADWIRE GREEN 40" DUAL/PINCH	Green 	RPI Part #LSG005 LEADWIRE GREEN 40" DUAL/SNAP	Green 
RPI Part #LPN005 LEADWIRE BROWN 40" DUAL/PINCH	Brown 	RPI Part #LSN005 LEADWIRE BROWN 40" DUAL/SNAP	Brown 
RPI Part #LPR005 LEADWIRE RED 40" DUAL/PINCH	Red 	RPI Part #LSR005 LEADWIRE RED 40" DUAL/SNAP	Red 
RPI Part #LPW005 LEADWIRE WHITE 40" DUAL/PINCH	White 	RPI Part #LSW005 LEADWIRE WHITE 40" DUAL/SNAP	White 

Depending on equipment model, these leadwires are also available as sets – see *REUSABLE: DUAL/SHIELDED LEADWIRE SETS* on previous page.

**NOTES:**

---

---

---

---

---

---

---

---

---

---

---

---

---

---

---

---

---

---

---

---

---

---

---

---

---



---

# General Biomedical Equipment

ECG, Monitoring & Defibrillators

## DISPOSABLE: DIN/UNSHIELDED LEADWIRE SETS

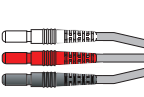
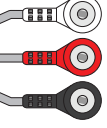
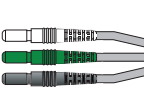
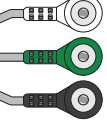
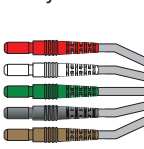
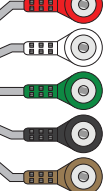
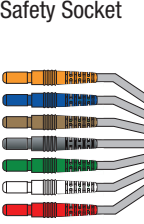
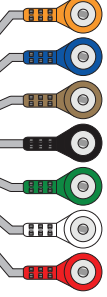
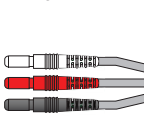
Accessories Also Available

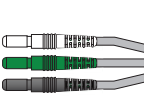
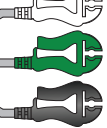
DESCRIPTION	EQUIPMENT END	PATIENT END
<p><b>RPI Part #LDM301</b></p> <p><b>3 LEADWIRE SET DISPOSABLE 24" DIN/SNAP</b></p> <ul style="list-style-type: none"> <li>• Disposable; 10 sets per package</li> <li>• Number of Leads: 3</li> <li>• Length: 24"</li> </ul> <p><b>Also available:</b></p> <ul style="list-style-type: none"> <li>• Reusable Leadwire Set (RPI Part #LKM005) &amp; 3 Lead Organizer (RPI Part #LAR004)</li> </ul>	<p>Din/Unshielded; .060" Safety Socket</p> 	<p>Snap</p>  <p>WHITE RED BLACK</p>
<p><b>RPI Part #LDM302</b></p> <p><b>3 LEADWIRE SET DISPOSABLE 24" DIN/SNAP</b></p> <ul style="list-style-type: none"> <li>• Disposable; 10 sets per package</li> <li>• Number of Leads: 3</li> <li>• Length: 24"</li> </ul> <p><b>Also available:</b></p> <ul style="list-style-type: none"> <li>• Reusable Leadwire Set (RPI Part #LKM011) &amp; 3 Lead Organizer (RPI Part #LAR004)</li> </ul>	<p>Din/Unshielded; .060" Safety Socket</p> 	<p>Snap</p>  <p>WHITE GREEN BLACK</p>
<p><b>RPI Part #LDM303</b></p> <p><b>5 LEADWIRE SET DISPOSABLE 24" DIN/SNAP</b></p> <ul style="list-style-type: none"> <li>• Disposable; 10 sets per package</li> <li>• Number of Leads: 5</li> <li>• Length: 24"</li> </ul> <p><b>Also available:</b></p> <ul style="list-style-type: none"> <li>• Reusable 24" Leadwire Set (RPI Part #LKM029), Reusable 40" Leadwire Set (RPI Part #LKM030) &amp; 5 Lead Organizer (RPI Part #LAR005)</li> </ul>	<p>Din/Unshielded; .060" Safety Socket</p> 	<p>Snap</p>  <p>RED WHITE GREEN BLACK BROWN</p>
<p><b>RPI Part #LDM304</b></p> <p><b>7 LEADWIRE SET DISPOSABLE 24" DIN/SNAP</b></p> <ul style="list-style-type: none"> <li>• Disposable; 10 sets per package</li> <li>• Number of Leads: 7</li> <li>• Length: 24"</li> </ul> <p><b>Also available:</b></p> <ul style="list-style-type: none"> <li>• Reusable Leadwire Set (RPI Part #LKM041)</li> </ul>	<p>Din/Unshielded; .060" Safety Socket</p> 	<p>Snap</p>  <p>ORANGE BLUE BROWN BLACK GREEN WHITE RED</p>
<p><b>RPI Part #LDM308</b></p> <p><b>3 LEADWIRE SET DISPOSABLE 24" DIN/PINCH</b></p> <ul style="list-style-type: none"> <li>• Disposable; 10 sets per package</li> <li>• Number of Leads: 3</li> <li>• Length: 24"</li> </ul> <p><b>Also available:</b></p> <ul style="list-style-type: none"> <li>• Reusable Leadwire Set (RPI Part #LKM002) &amp; 3 Lead Organizer (RPI Part #LAR004)</li> </ul>	<p>Din/Unshielded; .060" Safety Socket</p> 	<p>Pinch</p>  <p>WHITE RED BLACK</p>
<p><b>RPI Part #LDM309</b></p> <p><b>3 LEADWIRE SET DISPOSABLE 24" DIN/PINCH</b></p> <ul style="list-style-type: none"> <li>• Disposable; 10 sets per package</li> <li>• Number of Leads: 3</li> <li>• Length: 24"</li> </ul> <p><b>Also available:</b></p> <ul style="list-style-type: none"> <li>• Reusable Leadwire Set (RPI Part #LKM008) &amp; 3 Lead Organizer (RPI Part #LAR004)</li> </ul>	<p>Din/Unshielded; .060" Safety Socket</p> 	<p>Pinch</p>  <p>WHITE GREEN BLACK</p>

(continued on next page)

Accessories Also Available

## DISPOSABLE: DIN/UNSHIELDED LEADWIRE SETS (Continued)

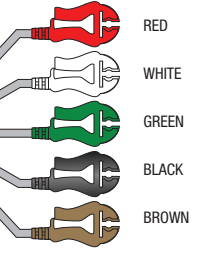
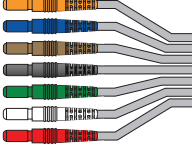
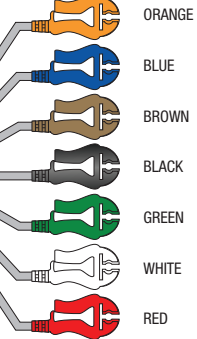
DESCRIPTION	EQUIPMENT END	PATIENT END
<p><b>RPI Part #LDM310</b></p> <p><b>5 LEADWIRE SET DISPOSABLE 24" DIN/PINCH</b></p> <ul style="list-style-type: none"> <li>• Disposable; 10 sets per package</li> <li>• Number of Leads: 5</li> <li>• Length: 24"</li> </ul> <p><b>Also available:</b></p> <ul style="list-style-type: none"> <li>• Reusable Leadwire Set (RPI Part #LKM026) &amp; 5 Lead Organizer (RPI Part #LAR005)</li> </ul>	<p>Din/Unshielded; .060" Safety Socket</p> 	<p>Pinch</p> 
<p><b>RPI Part #LDM311</b></p> <p><b>7 LEADWIRE SET DISPOSABLE 24" DIN/PINCH</b></p> <ul style="list-style-type: none"> <li>• Disposable; 10 sets per package</li> <li>• Number of Leads: 7</li> <li>• Length: 24"</li> </ul> <p><b>Also available:</b></p> <ul style="list-style-type: none"> <li>• Reusable Leadwire Set (RPI Part #LKM038)</li> </ul>	<p>Din/Unshielded; .060" Safety Socket</p> 	<p>Pinch</p> 

Accessories Also Available

## DISPOSABLE: DUAL/SHIELDED LEADWIRE SETS

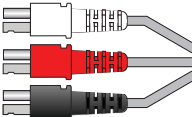
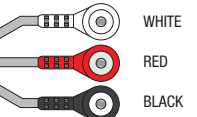
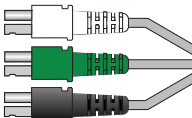
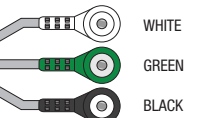
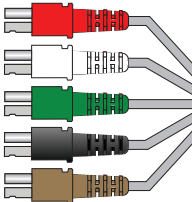
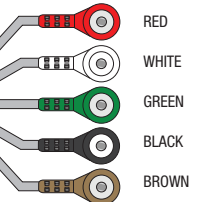
DESCRIPTION	EQUIPMENT END	PATIENT END
<p><b>RPI Part #LDM305</b></p> <p><b>3 LEADWIRE SET DISPOSABLE 30" DUAL/SNAP</b></p> <ul style="list-style-type: none"> <li>• Disposable; 10 sets per package</li> <li>• Number of Leads: 3</li> <li>• Length: 30"</li> </ul> <p><b>Also available:</b></p> <ul style="list-style-type: none"> <li>• Reusable Leadwire Set (RPI Part #LKM017) &amp; 3 Lead Shielded Accessory Kit (RPI Part #LAK006)</li> </ul>	<p>Dual/Shielded</p> 	<p>Snap</p> 
<p><b>RPI Part #LDM306</b></p> <p><b>3 LEADWIRE SET DISPOSABLE 30" DUAL/SNAP</b></p> <ul style="list-style-type: none"> <li>• Disposable; 10 sets per package</li> <li>• Number of Leads: 3</li> <li>• Length: 30"</li> </ul> <p><b>Also available:</b></p> <ul style="list-style-type: none"> <li>• Reusable Leadwire Set (RPI Part #LKM023) &amp; 3 Lead Shielded Accessory Kit (RPI Part #LAK006)</li> </ul>	<p>Dual/Shielded</p> 	<p>Snap</p> 
<p><b>RPI Part #LDM307</b></p> <p><b>5 LEADWIRE SET DISPOSABLE 30" DUAL/SNAP</b></p> <ul style="list-style-type: none"> <li>• Disposable; 10 sets per package</li> <li>• Number of Leads: 5</li> <li>• Length: 30"</li> </ul> <p><b>Also available:</b></p> <ul style="list-style-type: none"> <li>• Reusable Leadwire Set (RPI Part #LKM035) &amp; 5 Lead Shielded Accessory Kit (RPI Part #LAK007)</li> </ul>	<p>Dual/Shielded</p> 	<p>Snap</p> 

(continued on next page)

# General Biomedical Equipment

ECG, Monitoring & Defibrillators

## DISPOSABLE: DUAL/SHIELDED LEADWIRE SETS (Continued)



DESCRIPTION	EQUIPMENT END	PATIENT END
<p><b>RPI Part #LDM312</b></p> <p><b>3 LEADWIRE SET DISPOSABLE 30" DUAL/PINCH</b></p> <ul style="list-style-type: none"> <li>• Disposable; 10 sets per package</li> <li>• Number of Leads: 3</li> <li>• Length: 30"</li> </ul> <p><b>Also available:</b></p> <ul style="list-style-type: none"> <li>• Reusable Leadwire Set (RPI Part #LKM014) &amp; 3 Lead Shielded Accessory Kit (RPI Part #LAK006)</li> </ul>	<p>Dual/Shielded</p>	<p>Pinch</p> <p>WHITE RED BLACK</p>
<p><b>RPI Part #LDM313</b></p> <p><b>3 LEADWIRE SET DISPOSABLE 30" DUAL/PINCH</b></p> <ul style="list-style-type: none"> <li>• Disposable; 10 sets per package</li> <li>• Number of Leads: 3</li> <li>• Length: 30"</li> </ul> <p><b>Also available:</b></p> <ul style="list-style-type: none"> <li>• Reusable Leadwire Set (RPI Part #LKM020) &amp; 3 Lead Shielded Accessory Kit (RPI Part #LAK006)</li> </ul>	<p>Dual/Shielded</p>	<p>Pinch</p> <p>WHITE GREEN BLACK</p>
<p><b>RPI Part #LDM314</b></p> <p><b>5 LEADWIRE SET DISPOSABLE 30" DUAL/PINCH</b></p> <ul style="list-style-type: none"> <li>• Disposable; 10 sets per package</li> <li>• Number of Leads: 5</li> <li>• Length: 30"</li> </ul> <p><b>Also available:</b></p> <ul style="list-style-type: none"> <li>• Reusable Leadwire Set (RPI Part #LKM032) &amp; 5 Lead Shielded Accessory Kit (RPI Part #LAK007)</li> </ul>	<p>Dual/Shielded</p>	<p>Pinch</p> <p>RED WHITE GREEN BLACK BROWN</p>

## ACCESSORIES

DESCRIPTION	ACCESSORY
<p><b>RPI Part #LAC002</b></p> <p><b>3 LEAD COMBINER</b></p> <ul style="list-style-type: none"> <li>• Number of Leads: 3</li> <li>• Use with Dual/Shielded Leadwires only</li> </ul> <p><b>Also included in:</b></p> <ul style="list-style-type: none"> <li>• 3 Lead Shielded Accessory Kit (RPI Part #LAK006)</li> </ul>	
<p><b>RPI Part #LAR004</b></p> <p><b>3 LEAD ORGANIZER</b></p> <ul style="list-style-type: none"> <li>• Number of Leads: 3</li> </ul> <p><b>Also included in:</b></p> <ul style="list-style-type: none"> <li>• 3 Lead Shielded Accessory Kit (RPI Part #LAK006)</li> </ul>	
<p><b>RPI Part #LAK006</b></p> <p><b>3 LEAD SHIELDED ACCESSORY KIT</b></p> <ul style="list-style-type: none"> <li>• Number of Leads: 3</li> <li>• Shielded Accessory Kit</li> <li>• Use with Dual/Shielded Leadwires only</li> <li>• Includes all parts as shown</li> </ul>	<p>LAR004      LAC002</p>

DESCRIPTION	ACCESSORY
<p><b>RPI Part #LAC003</b></p> <p><b>5 LEAD COMBINER</b></p> <ul style="list-style-type: none"> <li>• Number of Leads: 5</li> <li>• Use with Dual/Shielded Leadwires only</li> </ul> <p><b>Also included in:</b></p> <ul style="list-style-type: none"> <li>• 5 Lead Shielded Accessory Kit (RPI Part #LAK007)</li> </ul>	
<p><b>RPI Part #LAR005</b></p> <p><b>5 LEAD ORGANIZER</b></p> <ul style="list-style-type: none"> <li>• Number of Leads: 5</li> </ul> <p><b>Also included in:</b></p> <ul style="list-style-type: none"> <li>• 5 Lead Shielded Accessory Kit (RPI Part #LAK007)</li> </ul>	
<p><b>RPI Part #LAK007</b></p> <p><b>5 LEAD SHIELDED ACCESSORY KIT</b></p> <ul style="list-style-type: none"> <li>• Number of Leads: 5</li> <li>• Shielded Accessory Kit</li> <li>• Use with Dual/Shielded Leadwires only</li> <li>• Includes all parts as shown</li> </ul>	<p>LAR005      LAC003</p>



## VETERINARY: DIN/UNSHIELDED LEADWIRE SETS

DESCRIPTION	EQUIPMENT END	PATIENT END
<p><b>RPI Part #LVM701</b></p> <p><b>3 LEADWIRE SET - 24" DIN/ALLIGATOR</b></p> <ul style="list-style-type: none"> <li>• Number of Leads: 3</li> <li>• Length: 24"</li> <li>• Recommended for veterinary use only</li> </ul> <p><b>Also available:</b></p> <ul style="list-style-type: none"> <li>• 3 Lead Organizer (RPI Part #LAR004)</li> </ul>	<p>Din/Unshielded; .060" Safety Socket</p>	<p>Alligator Clip</p> <p>WHITE</p> <p>RED</p> <p>BLACK</p>
<p><b>RPI Part #LVM702</b></p> <p><b>3 LEADWIRE SET - 24" DIN/ALLIGATOR</b></p> <ul style="list-style-type: none"> <li>• Number of Leads: 3</li> <li>• Length: 24"</li> <li>• Recommended for veterinary use only</li> </ul> <p><b>Also available:</b></p> <ul style="list-style-type: none"> <li>• 3 Lead Organizer (RPI Part #LAR004)</li> </ul>	<p>Din/Unshielded; .060" Safety Socket</p>	<p>Alligator Clip</p> <p>WHITE</p> <p>GREEN</p> <p>BLACK</p>
<p><b>RPI Part #LVM703</b></p> <p><b>5 LEADWIRE SET - 24" DIN/ALLIGATOR</b></p> <ul style="list-style-type: none"> <li>• Number of Leads: 5</li> <li>• Length: 24"</li> <li>• Recommended for veterinary use only</li> </ul> <p><b>Also available:</b></p> <ul style="list-style-type: none"> <li>• 5 Lead Organizer (RPI Part #LAR005)</li> </ul>	<p>Din/Unshielded; .060" Safety Socket</p>	<p>Alligator Clip</p> <p>RED</p> <p>WHITE</p> <p>GREEN</p> <p>BLACK</p> <p>BROWN</p>
<p><b>RPI Part #LVM704</b></p> <p><b>7 LEADWIRE SET - 24" DIN/ALLIGATOR</b></p> <ul style="list-style-type: none"> <li>• Number of Leads: 7</li> <li>• Length: 24"</li> <li>• Recommended for veterinary use only</li> </ul> <p><b>Also available:</b></p> <ul style="list-style-type: none"> <li>• 3 Lead Organizer (RPI Part #LAR004) &amp;</li> <li>• 5 Lead Organizer (RPI Part #LAR005)</li> </ul>	<p>Din/Unshielded; .060" Safety Socket</p>	<p>Alligator Clip</p> <p>ORANGE</p> <p>BLUE</p> <p>BROWN</p> <p>BLACK</p> <p>GREEN</p> <p>WHITE</p> <p>RED</p>

## VETERINARY: DUAL/SHIELDED LEADWIRE SETS



DESCRIPTION	EQUIPMENT END	PATIENT END
<p><b>RPI Part #LVM705</b></p> <p><b>3 LEADWIRE SET - 30" DUAL/ALLIGATOR</b></p> <ul style="list-style-type: none"> <li>• Number of Leads: 3</li> <li>• Length: 30"</li> <li>• Recommended for veterinary use only</li> </ul> <p><b>Also available:</b></p> <ul style="list-style-type: none"> <li>• 3 Lead Shielded Accessory Kit (RPI Part #LAK006)</li> </ul>	<p>Dual/Shielded</p>	<p>Alligator Clip</p> <p>WHITE</p> <p>RED</p> <p>BLACK</p>

(continued on next page)

# General Biomedical Equipment

ECG, Monitoring & Defibrillators

## VETERINARY: DUAL/SHIELDED LEADWIRE SETS (Continued)



DESCRIPTION	EQUIPMENT END	PATIENT END
<b>RPI Part #LVM706</b> <b>3 LEADWIRE SET - 30" DUAL/ALLIGATOR</b> <ul style="list-style-type: none"> <li>• Number of Leads: 3</li> <li>• Length: 30"</li> <li>• Recommended for veterinary use only</li> </ul> <b>Also available:</b> <ul style="list-style-type: none"> <li>• 3 Lead Shielded Accessory Kit (RPI Part #LAK006)</li> </ul>	Dual/Shielded 	Alligator Clip 
<b>RPI Part #LVM707</b> <b>5 LEADWIRE SET - 30" DUAL/ALLIGATOR</b> <ul style="list-style-type: none"> <li>• Number of Leads: 5</li> <li>• Length: 30"</li> <li>• Recommended for veterinary use only</li> </ul> <b>Also available:</b> <ul style="list-style-type: none"> <li>• 5 Lead Shielded Accessory Kit (RPI Part #LAK007)</li> </ul>	Dual/Shielded 	Alligator Clip 

## VETERINARY: INDIVIDUAL LEADWIRES

DIN/UNSHIELDED		DUAL/SHIELDED	
<ul style="list-style-type: none"> <li>• Equipment End: Din/Unshielded, .060 Safety Socket</li> <li>• Patient End: Alligator Clip</li> <li>• Length: 24"</li> </ul>		<ul style="list-style-type: none"> <li>• Equipment End: Dual/Shielded</li> <li>• Patient End: Alligator Clip</li> <li>• Length: 30"</li> </ul>	
DESCRIPTION	LEADWIRE COLOR	DESCRIPTION	LEADWIRE COLOR
RPI Part #LGB002 LEADWIRE BLACK 24" DIN/ALLIGATOR	Black	RPI Part #LGB004 LEADWIRE BLACK 30" DUAL/ALLIGATOR	Black
RPI Part #LGE002 LEADWIRE ORANGE 24" DIN/ALLIGATOR	Orange	RPI Part #LGG004 LEADWIRE GREEN 30" DUAL/ALLIGATOR	Green
RPI Part #LGG002 LEADWIRE GREEN 24" DIN/ALLIGATOR	Green	RPI Part #LGN004 LEADWIRE BROWN 30" DUAL/ALLIGATOR	Brown
RPI Part #LGN002 LEADWIRE BROWN 24" DIN/ALLIGATOR	Brown	RPI Part #LGR004 LEADWIRE RED 30" DUAL/ALLIGATOR	Red
RPI Part #LGR002 LEADWIRE RED 24" DIN/ALLIGATOR	Red	RPI Part #LGW004 LEADWIRE WHITE 30" DUAL/ALLIGATOR	White
RPI Part #LJU002 LEADWIRE BLUE 24" DIN/ALLIGATOR	Blue	Depending on equipment model, these leadwires are also available as sets – see <i>VETERINARY: DIN/UNSHIELDED LEADWIRE SETS</i> and <i>VETERINARY: DUAL/SHIELDED LEADWIRE SETS</i> on previous page.	
RPI Part #LGW002 LEADWIRE WHITE 24" DIN/ALLIGATOR	White		





**RPI Part #WAB001**  
**OEM Part #747284-501**  
**POWER SUPPLY BOARD (3.5V)**

- 3.5VDC
- Includes all parts as shown
- Also available: Position Control Knob (RPI Part #BUK043)

**Fits:** Chassis  
**Model:** 74710

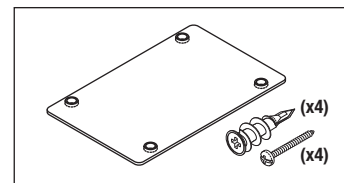
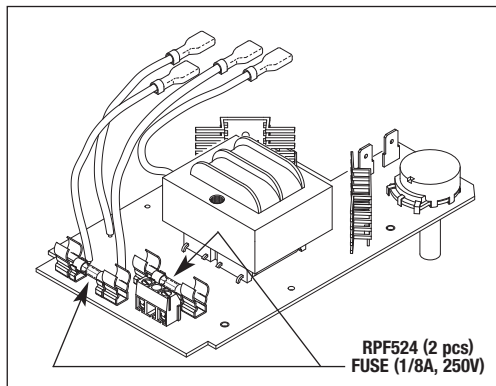

**RPI Part #WAB004**  
**OEM Part #747145**  
**WALL BRACKET**

- Size: 4.16" lg. x 3.0" wd. x .06" thk.
- Material: Aluminum
- Includes: Mounting hardware

**Fits:** Mounting Plate  
**Model:** 74710

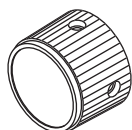

**RPI Part #BUK043**  
**OEM Part #747116-1**  
**POSITION CONTROL KNOB**

- Material: Black plastic knob, aluminum face plate
- Size: .92" OD x .64" lg.
- Shaft Size: 1/4" dia.
- Includes: (2) installed set screws

**Fits:** Control Panel  
**Model:** 74710

**RPI Part #RPF524**  
**OEM Part #711571-1**  
**FUSE (1/8A, 250V) - TIME DELAY**

- 5 per package
- Type: Glass
- Size: 5mm dia. x 20mm lg.
- Included in: Power Supply Board (3.5V) (RPI Part #WAB001) and Fuse Kit (RPI Part #RPK538)

**Fits:** Power Supply Board  
**Model:** 74710

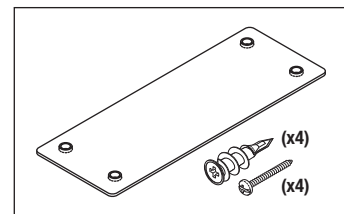
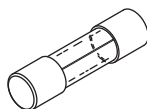

**RPI Part #WAB007**  
**OEM Part #767035-501**  
**WALL BRACKET**

- Size: 6.0" lg. x 2.2" wd. x .06" thk.
- Material: Aluminum
- Includes: Mounting hardware

**Fits:** Mounting Plate  
**Model:** 767



**RPI Part #WAK003**  
**OEM Part #747300-501**  
 (Complete Handpiece Assembly)

**COILED CORD KIT**

- Size: 2 Conductor #20 AWG x ~3 ft. lg.
- Includes all parts as shown
- Now you can replace just the Coiled Cord instead of the whole Handpiece Assembly - It's the RPI Advantage!
- Also available: Strain Relief Bushing Pliers (RPI Part #RPT172)

**Fits:** Handpiece  
**Model:** 74710

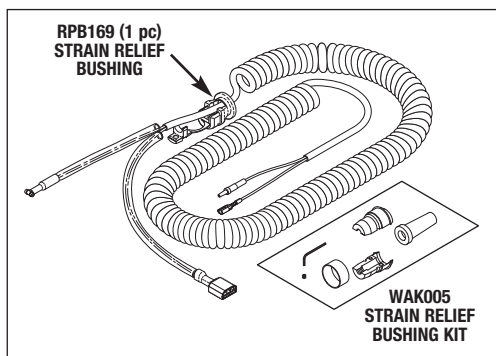

**RPI Part #WAS002**  
**OEM Part #747014-2**

**MICROSWITCH**

- Momentary
- 4A @ 250VAC; SPDT
- .058" dia. Pin Terminals

**Fits:** Handle Mounting Bracket  
**Model:** 74710

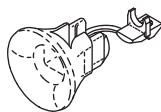
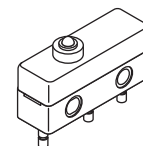

**RPI Part #RPB169**  
**OEM Part #745184**  
**STRAIN RELIEF BUSHING**

- 8 per package
- Type: SR-5N-5
- Accommodates: .250" - .290" dia. round Cord
- Mounting Hole: 1/2" dia.
- Included in: Strain Relief Bushing Kit (RPI Part #RPK412) and Coiled Cord (RPI Part #WAK003)
- Also available: Strain Relief Bushing Pliers (RPI Part #RPT172)

**Fits:** Handpiece Coiled Cord  
**Models:** 74710

**RPI Part #WAK005**  
**OEM Part #**  
 (No OEM Part # Available)

**STRAIN RELIEF BUSHING KIT**

- Fits .190" dia. cord
- Includes: Bushing, rubber boot, dress ring, set screw and .035" hex wrench
- Now you can reset the handpiece without replacing the entire coiled cord - It's the RPI Advantage!
- Included in: Coiled Cord (RPI Part WAK003)

**Fits:** Handpiece Coiled Cord  
**Model:** 74710

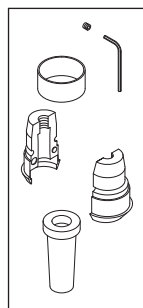

**RPI Part #TUS009**  
**OEM Part #483311-2**

**POWER SWITCH**

- Rocker switch (On-Off)
- 20A @ 125/250VAC; DPST
- Color: Black body with illuminated green lens; Legend: I/O
- 1/4" Tabs

**Fits:** Main Housing  
**Model:** 74710

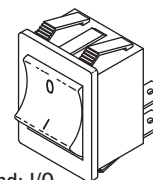

**RPI Part #WAS008**  
**OEM Part #236707-1**

**POWER SWITCH**

- Rocker Switch (ON - OFF)
- 16A @ 250VAC; DPST
- Color: Black body with illuminated green lens
- 1/4" Tabs

**Fits:** Main Housing  
**Model:** 767

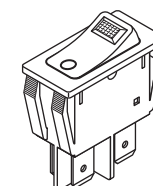

# General Biomedical Equipment

Models: 74710 & 767

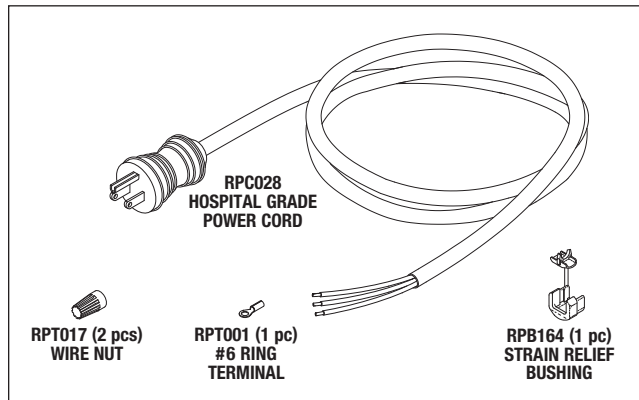

**RPI Part #CAK120**  
**OEM Part #747306-501** (Power Cord only)/711314 (Strain Relief only)

**POWER CORD KIT**

- Length: 8 ft.; Color: Gray
- 18/3 SJT, 60°C; 10A @ 125VAC
- Plug: NEMA 5-15P; Connector: None
- Includes all parts as shown
- Also available: Strain Relief Bushing Pliers (RPI Part #RPT172)

**Fits:** Chassis  
**Model:** 74710

**RPI Part #RPB164**  
**OEM Part #** (No OEM Part # Available)

**STRAIN RELIEF BUSHING**

- 8 per package
- Type: SR-6N3-4
- Accommodates: .325" - .360" dia. round cord
- Mounting Hole: 5/8" dia. x 1/8" thk. panel max.
- Included in: Strain Relief Bushing Kit (RPI Part #RPK412)
- Also available: Strain Relief Bushing Pliers (RPI Part #RPT172)

**Fits:** Power Cord  
**Models:** 74710

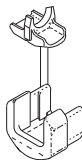

**RPI Part #RPC557**  
**OEM Part #761069**

**HOSPITAL GRADE POWER CORD**

- Length: 8 ft.; Color: Gray
- 16/3 SJT, 60°C; 13A @ 125VAC
- Plug: NEMA 5-15P
- Connector: EN60320-C13

**Fits:** Power Input Module  
**Model:** 767

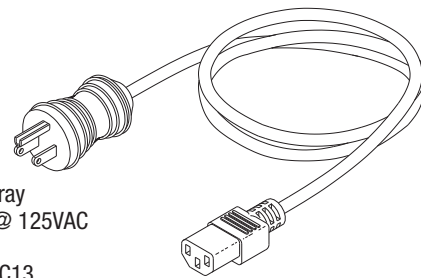

**RPI Part #RPF508**  
**OEM Part #236706-3111**

**FUSE (1/4A, 250V) - FAST ACTING**

- 5 per package
- Type: Glass
- Size: 5mm dia. x 20mm lg.
- Included in: Fuse Kit (RPI Part #RPK520)

**Fits:** Power Supply Board  
**Model:** 767

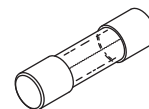

**RPI Part #RPT172**  
**OEM Part #** (No OEM Part # Available)

**STRAIN RELIEF BUSHING PLIERS**

- Hand pliers adjustable for all strain relief bushings that assemble into mounting hole up to 7/8" diameter
- Size: 7" lg.
- Also available: Strain Relief Bushing Kit (RPI Part #RPK412)

**Models:** 74710

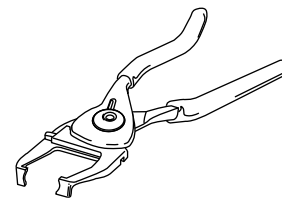

## Lamps for Exam Heads

**RPI Part #LMP109**  
**OEM Part #WA-03100-U**

**LAMP**

- 6 per package
- 3.5V, 2.52W
- Shape: T1.5; Xenon

**Fits:** Examination Head

**Models:** 20000 Otoscope, 20200 Otoscope, 20202 Otoscope, 21700 Otoscope, 25000 Otoscope, 25020 Otoscope, 25200 Otoscope, 26530 Illuminator, 27000 Illuminator, 27050 Illuminator, 28100 Tongue Blade Holder, 41100 Illuminator, 43300 Illuminator & 73500 Handle Adapter

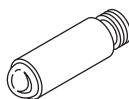

**RPI Part #LMP110**  
**OEM Part #WA-03000-U**

**LAMP**

- 6 per package
- 3.5V, 2.52W
- Shape: T1.5; Xenon
- Single contact 8mm flange

**Fits:** Examination Head

**Models:** 11600 Ophthalmoscope, 11605 Ophthalmoscope, 11610 Ophthalmoscope, 11710 Ophthalmoscope, 12400 Strabismoscope, 18000 Retinoscope & 43700 Episcopes

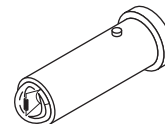

**RPI Part #LMP111**  
**OEM Part #WA-06500-U**

**LAMP**

- 6 per package
- 3.5V, 2.73W
- Shape: TL1.5; Xenon

**Fits:** Examination Head

**Models:** 23810 Otoscope & 23820 Otoscope

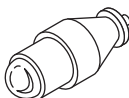

**RPI Part #LMP112**  
**OEM Part #WA-03800-U**

**LAMP**

- 6 per package
- 3.5V, 2.33W
- Shape: T1.5; Xenon

**Fits:** Examination Head

**Models:** 11800 Ophthalmoscope, 11810 Ophthalmoscope & 11820 Ophthalmoscope

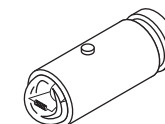

Models: Force 1C, Force 2-2, Force 2-8, Force 4, Force 30, Force 40, Force EZ, Force EZ-C, Force EZ-8, Force EZ-8C, Force FX, Force FX-C, Force FX-8, Force FX-8C & Force Triad

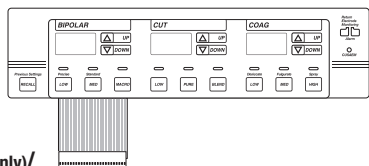

**RPI Part #CVP012**  
**OEM Part #1012634 (Keypad Only)/**  
**223 200 667 (Control Panel Only)**

**KEYPAD (FRONT PANEL)**

- Includes: Front panel keypad and control panel
- Size: 3.34" x 13.44"
- Adhesive backing
- Also available: Overlay (Connector Panel) (RPI Part #CVP013)

**Fits:** Front Panel

**Models:** Force FX & Force FX-C

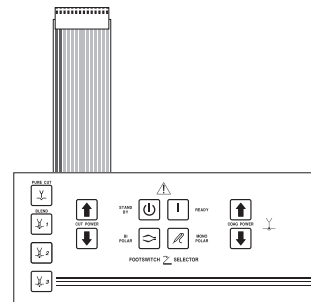

**RPI Part #CVP008**  
**OEM Part #207 500 147**

**KEYPAD (MONOPOLAR)**

- Size: 3.50" x 8.00"
- Material: Anodized aluminum backing panel

• Also available: Adhesive (RTV108) (RPI Part #RPA874)

**Fits:** Front Control Panel

**Models:** Force 2-2

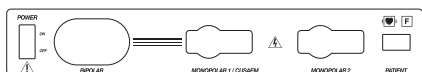

**RPI Part #CVP013**  
**OEM Part #1020029**

**OVERLAY (CONNECTOR PANEL)**

- Size: 2.12" x 13.44"
- Adhesive backing
- Also available: Keypad (Front Panel) (RPI Part #CVP012)

**Fits:** Front Panel

**Models:** Force FX & Force FX-C

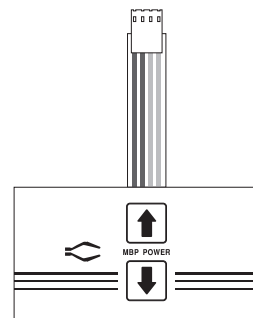

**RPI Part #CVP009**  
**OEM Part #207 500 148**

**KEYPAD (BIPOLAR)**

- Size: 1.75" x 3.25"
- Material: Anodized aluminum backing panel

• Also available: Adhesive (RTV108) (RPI Part #RPA874)

**Fits:** Front Control Panel

**Models:** Force 2-2

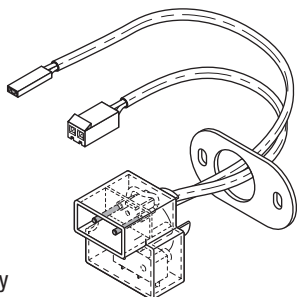

**RPI Part #CVA016**  
**OEM Part #202 701 854**

**RETURN MODULE ASSEMBLY**

- Replacement for the REM® Assembly
- Switch: 0.1A @ 125/250V, 50/60 Hz.

**Fits:** Front Panel

**Models:** Force 30, Force 40, Force FX, Force FX-C, Force FX-8 & Force FX-8C

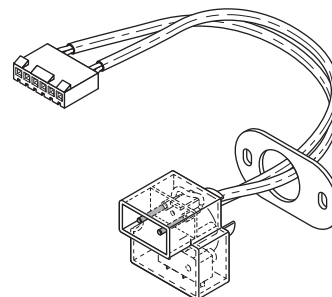

**RPI Part #CVA015**  
**OEM Part # (No OEM Part # Available)**

**RETURN MODULE ASSEMBLY**

- Replacement for the REM® Assembly
- Switch: 0.1A @ 125/250V, 50/60 Hz.

**Fits:** Front Panel

**Models:** Force 2-2

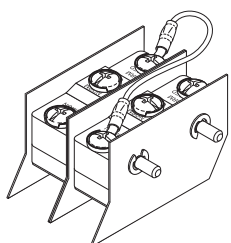

**RPI Part #CVA001**  
**OEM Part # (No OEM Part # Available)**

**FOOTSWITCH ASSEMBLY**

- Monopolar
- 20A @ 125/250VAC

**Fits:** E6008 Monopolar Footswitch

**Models:** Force 1C, Force 2-2, Force 2-8, Force 4, Force 30, Force 40, Force EZ, Force EZ-C, Force EZ-8, Force EZ-8C, Force FX, Force FX-C, Force FX-8, Force FX-8C & Force Triad

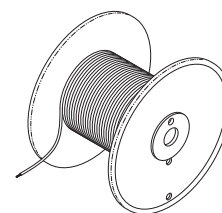

**RPI Part #RPW906**  
**OEM Part # (No OEM Part # Available)**

**HOOK UP WIRE (BLACK)**

- Sold by the foot (reel **not** included)
- #18 AWG, 16/30 strands, UL 1569
- Insulation: PVC; 221°F (105°C); 300V
- For use with Footswitch Assembly (RPI Part #CVA001)

**Fits:** E6008 Monopolar Footswitch

**Models:** Force 1C, Force 2-2, Force 2-8, Force 4, Force 30, Force 40, Force EZ, Force EZ-C, Force EZ-8, Force EZ-8C, Force FX, Force FX-C, Force FX-8, Force FX-8C & Force Triad

# General Biomedical Equipment

Models: Force 1C, Force 2-2, Force 2-8, Force 4, Force 30, Force 40, Force EZ, Force EZ-C, Force EZ-8, Force EZ-8C, Force FX, Force FX-C, Force FX-8, Force FX-8C & Force Triad

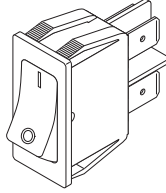

**RPI Part #CVS014**  
**OEM Part #243 025 037**

**POWER SWITCH**

- Rocker Switch (On-Off)
- 16A @ 125/250VAC; DPST
- Black body and rocker
- 1/4" Tabs
- Panel Cutout: .480" x 1.071"

**Fits:** Front Control Panel  
**Models:** Force FX & Force FX-C

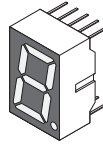

**RPI Part #LMD036**  
**OEM Part #239 750 071**

**NUMERIC DISPLAY LED**

- 3 per package
- 7 Segment display (green)
- Character height: 14.2mm (.56")
- Configuration: 10 Pin DIP

**Fits:** Display Board  
**Models:** Force FX & Force FX-C

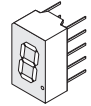

**RPI Part #LMD031**  
**OEM Part #239 750 029**

**NUMERIC DISPLAY LED**

- 3 per package
- 7 Segment display (red)
- Character height: 7.62mm (.30")
- Configuration: 10 Pin DIP

**Fits:** Display Board  
**Models:** Force 2-2

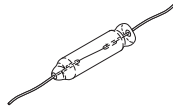

**RPI Part #LMP030**  
**OEM Part #215 200 085**

**LAMP**

- 4 per package
- 12V, .055A, .66W; Axial Lead
- Type: Incandescent
- Can be used in place of radial lead bulb

**Fits:** Display Board  
**Models:** Force FX, Force FX-C & Force 2-2

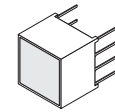

YELLOW/GREEN & RED

**RPI Part #LMD037**  
**OEM Part #239 750 076**

**LED INDICATOR (MULTI)**

- 3 per package
- Bi-color display (yellow/green and red)
- Configuration: 8 Pin DIP

**Fits:** Display Board  
**Models:** Force FX & Force FX-C

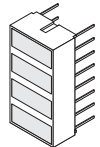

YELLOW

**RPI Part #LMD032**  
**OEM Part #239 750 022**

**LED LIGHT BAR**

- Color: 4 Yellow light emitting sections
- Configuration: 16 Pin DIP

**Fits:** Display Board  
**Models:** Force 2-2

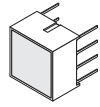

GREEN

**RPI Part #LMD033**  
**OEM Part #239 750 039**

**LED INDICATOR (GREEN)**

- 3 per package
- Configuration: 8 Pin DIP

**Fits:** Display Board  
**Models:** Force 2-2

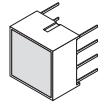

RED

**RPI Part #LMD034**  
**OEM Part #239 750 042**

**LED INDICATOR (RED)**

- 3 per package
- Configuration: 8 Pin DIP

**Fits:** Display Board  
**Models:** Force 2-2

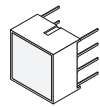

YELLOW

**RPI Part #LMD035**  
**OEM Part #239 750 033**

**LED INDICATOR (YELLOW)**

- 3 per package
- Configuration: 8 Pin DIP

**Fits:** Display Board  
**Models:** Force 2-2

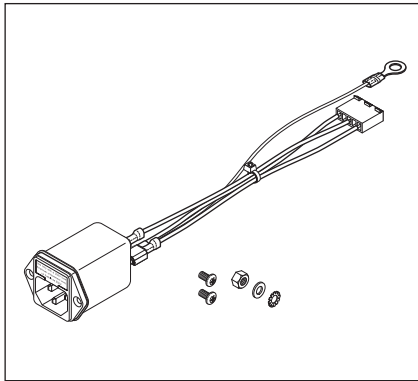

**RPI Part #CVA010**  
**OEM Part #202 701 890**

**LINE FILTER ASSEMBLY**

- 5mm dia. x 20mm lg. fuses not included
- 10A @ 125/250VAC, 50-60 Hz.
- Also available:
  - Fuse (8A, 250V) (RPI Part #RPF535) to fit 120VAC Force FX and Force FX-C and
  - Fuse (4A, 250V) (RPI Part #RPF533) to fit 220VAC Force FX-8 and Force FX-8C

**Fits:** Rear Panel  
**Models:** Force FX, Force FX-C, Force FX-8 & Force FX-8C

**RPI Part #RPF535**  
**OEM Part #215 100 074**

**FUSE (8A, 250V) - TIME DELAY**

- 5 per package
- Type: Glass, Time Delay
- Size: 5mm dia. x 20mm lg.
- Included in: Fuse Kit (RPI Part #RPK538)

**Fits:** Line Filter Assembly in 120V Units  
**Models:** Force FX and Force FX-C

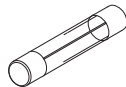

**RPI Part #RPF533**  
**OEM Part #215 100 074**

**FUSE (4A, 250V) - TIME DELAY**

- 5 per package
- Type: Glass, Time Delay
- Size: 5mm dia. x 20mm lg.
- Included in: Fuse Kit (RPI Part #RPK538)

**Fits:** Line Filter Assembly in 220V Units  
**Models:** Force FX-8 and FX-8C

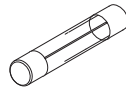

Models: Force 1C, Force 2-2, Force 2-8, Force 4, Force 30, Force 40, Force EZ, Force EZ-C, Force EZ-8, Force EZ-8C, Force FX, Force FX-C, Force FX-8, Force FX-8C & Force Triad



**RPI Part #CVA007**  
**OEM Part #** (No OEM Part # Available)  
**VOLUME CONTROL ASSEMBLY**

- 100 Ω Potentiometer
- 19" lg. wires with connector
- Includes all parts as shown

**Fits:** Rear Panel  
**Models:** Force 2-2

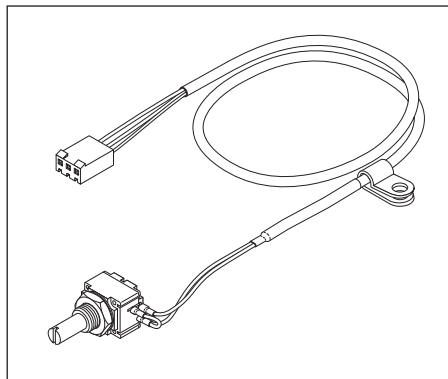

**CVR004**  
**CVR003**

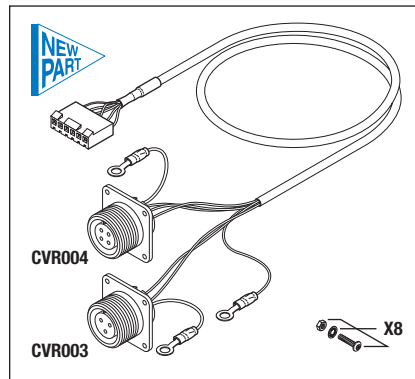

**RPI Part #CVA002**  
**OEM Part #** (No OEM Part # Available)

**FOOTSWITCH RECEPTACLE ASSEMBLY**

- 25" lg. shielded cable
- Includes all parts as shown

**Fits:** Rear Panel  
**Models:** Force 2-2



**RPI Part #CVA005**  
**OEM Part #** (No OEM Part # Available)  
**POWER HARNESS ASSEMBLY**

- Includes all parts as shown

**Fits:** Rear Panel to Transformer  
**Models:** Force 2-2

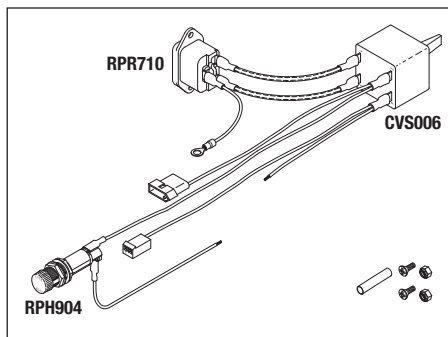

**RPI Part #CVR003**  
**OEM Part #** (No OEM Part # Available)

**BIPOLAR RECEPTACLE**

- 3-Socket receptacle
- Material: Aluminum body, clear finish
- Termination style: Solder
- Included in: Footswitch Receptacle Assembly (RPI Part #CVA002)

**Fits:** Rear Panel  
**Models:** Force 1C, Force 2-2, Force 2-8, Force 4, Force 30, Force 40, Force EZ, Force EZ-C, Force EZ-8, Force EZ-8C, Force FX, Force FX-C, Force FX-8, Force FX-8C & Force Triad

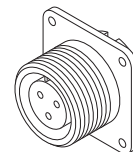

**RPI Part #CVS006**  
**OEM Part #** (No OEM Part # Available)  
**POWER SWITCH/CIRCUIT BREAKER**

- Toggle Switch (On-Off); 12.5A circuit breaker
- 12.5A @ 125/250VAC, 50/60 Hz.
- 1/4" Tabs
- Mounting hole size: .500" dia.
- Includes: Mounting hardware
- Included in: Power Harness Assembly (RPI Part #CVA005)

**Fits:** Rear Panel  
**Models:** Force 2-2

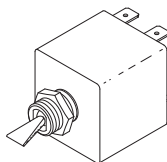

**RPI Part #RPH904**  
**OEM Part #** (No OEM Part # Available)  
**FUSE HOLDER**

- Accommodates standard 1/4" x 1-1/4" fuse
- 20A @ 250VAC
- 1/4" Tabs; Black body
- Mounting hole size: .500" dia.; Mounts through front or rear of panel
- Includes: Mounting hardware
- Included in: Power Harness Assembly (RPI Part #CVA005)
- Also available: Fuse (1A, 250V) (RPI Part #RPF045)

**Fits:** Rear Panel  
**Models:** Force 2-2

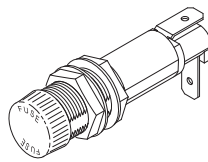

**RPI Part #CVR004**  
**OEM Part #** (No OEM Part # Available)

**MONOPOLAR RECEPTACLE**

- 4-Socket receptacle
- Material: Aluminum body, clear finish
- Termination style: Solder
- Included in: Footswitch Receptacle Assembly (RPI Part #CVA002)

**Fits:** Rear Panel  
**Models:** Force 1C, Force 2-2, Force 2-8, Force 4, Force 30, Force 40, Force EZ, Force EZ-C, Force EZ-8, Force EZ-8C, Force FX, Force FX-C, Force FX-8, Force FX-8C & Force Triad

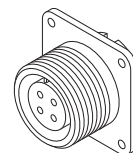

**RPI Part #RPR710**  
**OEM Part #** (No OEM Part # Available)  
**AC INLET RECEPTACLE**

- 15A @ 125VAC; 1/4" Tabs
- Keyed Mating Feature
- Includes: (2) sets of mounting hardware
- Fits panel cut-out: .787" x 1.083"
- Included in: Power Harness Assembly (RPI Part #CVA005)

**Models:** Force 2-2

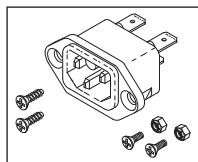

**RPI Part #RPF045**  
**OEM Part #** (No OEM Part # Available)

**FUSE (1A, 250V) FAST ACTING**

- 5 per package
- Type: Glass, AGC Fast Acting
- Size: 1/4" dia. x 1-1/4" lg.
- Included in: Fuse Kit (RPI Part #RPK410)

**Fits:** Fuse Holder (RPI Part #RPH904)  
**Models:** Force 2-2

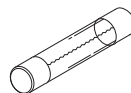

# General Biomedical Equipment

Models: Force 1C, Force 2-2, Force 2-8, Force 4, Force 30, Force 40, Force EZ, Force EZ-C, Force EZ-8, Force EZ-8C, Force FX, Force FX-C, Force FX-8, Force FX-8C & Force Triad

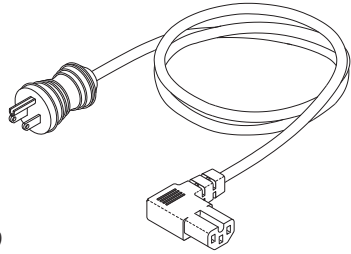

**RPI Part #RPC881**  
**OEM Part #** (No OEM Part # Available)

**HOSPITAL GRADE POWER CORD**

- Length: 15 ft.; Color: Gray
- 16/3 SJT, 105°C, 13A @ 125VAC
- Plug Type: NEMA 5-15P; Clear
- Connector Type: EN60320-C15 Right Angle (keyed mating feature)

**Fits:** Power Entry Module  
**Models:** Force 2-2

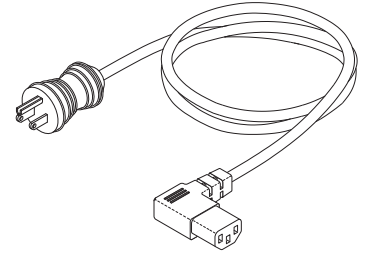

**RPI Part #RPC784**  
**OEM Part #207 002 060**

**HOSPITAL GRADE POWER CORD**

- Length: 18 ft.; Color: Gray
- 16/3 SJT, 105°C, 13A @ 125VAC
- Plug Type: NEMA 5-15P
- Connector Type: EN60320-C13R

**Models:** Force FX and Force FX-C

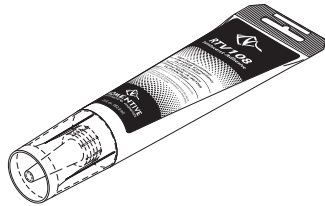

**RPI Part #RPA874**  
**OEM Part #** (No OEM Part # Available)

**ADHESIVE (RTV108)**

- Size: 2.8 fl. oz. tube
- Translucent silicone adhesive/sealant
- Temperature Range: -75°F to +400°F

**Models:** Force 2-2

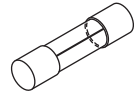

**RPI Part #RPF882**  
**OEM Part #215 100 041**

**FUSE (6.3A, 250V) - 5mm x 20mm - FAST ACTING**

- 5 per package
- Type: Glass, AGC Fast Acting
- Size: 5mm dia. x 20mm lg.

**Fits:** Power Supply/RF Board  
**Models:** Force 2-8, Force 30, Force 40, Force EZ, Force EZ-C, Force EZ-8, Force EZ-8C, Force FX, Force FX-C, Force FX-8 & Force FX-8C

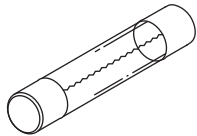

**RPI Part #RPF052**  
**OEM Part #215 005 039**

**FUSE (6A, 250V) - 1/4 x 1-1/4 - FAST ACTING**

- 5 per package
- Type: Glass, AGC Fast Acting
- Size: 1/4" dia. x 1-1/4" lg.
- Included in: Fuse Kit (RPI Part #RPK410)

**Fits:** Power Supply/RF board  
**Models:** Force 2-2 & Force 4

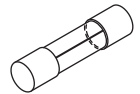

**RPI Part #RPF367**  
**OEM Part #** (No OEM Part # Available)

**FUSE (2A, 250V) - 5mm x 20mm - FAST ACTING**

- 5 per package
- Type: Glass, AGC Fast Acting
- Size: 5mm dia. x 20mm lg.
- Included in: Fuse Kit (RPI Part #RPK520)

**Fits:** Force FX-C with Low Voltage Boards  
**Models:** Force FX-C

**NOTES:** \_\_\_\_\_  
 \_\_\_\_\_  
 \_\_\_\_\_  
 \_\_\_\_\_  
 \_\_\_\_\_  
 \_\_\_\_\_  
 \_\_\_\_\_



# New Line of Parts to fit Covidien/Puritan Bennett™ 840 Ventilators!



RPI Part #CVK501  
OEM Part #4-079056-00

### VENTILATOR PM KIT (WITH LAMPS - 9.4" GUI)

- 10,000 hour Planned Maintenance Kit
- Includes: Air Inlet Filter (RPI Part #CVF502), Oxygen Inlet Filter (RPI Part #CVF503), Lamp (RPI Part #CVL505), and PM Sticker

Models: 840

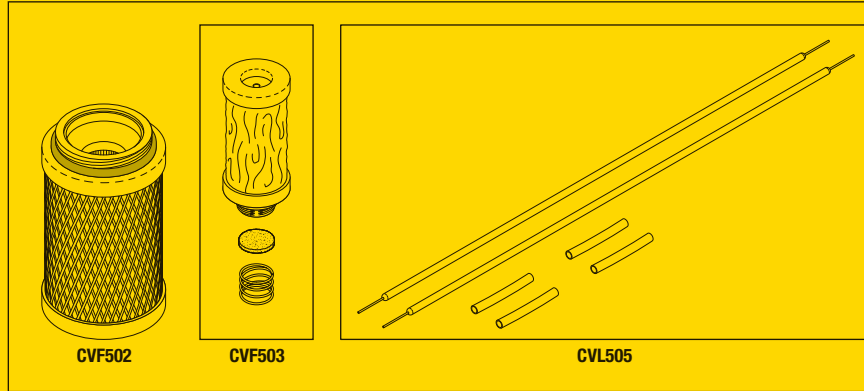

CVF502

CVF503

CVL505



RPI Part #CVK500  
OEM Part #4-078179-00

### VENTILATOR PM KIT (10.4" GUI)

- 10,000 hour Planned Maintenance Kit
- Includes: Air Inlet Filter (RPI Part #CVF502), Oxygen Inlet Filter (RPI Part #CVF503), and PM Sticker

Models: 840

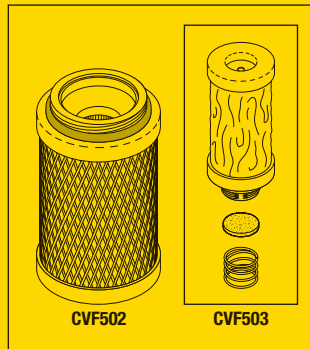

CVF502

CVF503

RPI Part #CVF502  
OEM Part #4-072203-00

### AIR INLET FILTER

- 0.3 micron
- Size: 1-3/4" dia. x 2-3/4" lg.
- Included in: Ventilator PM Kit (10.4" GUI) (RPI Part #CVK500) and Ventilator PM Kit (with Lamps - 9.4" GUI) (RPI Part #CVK501)
- Also available: Oxygen Inlet Filter (RPI Part #CVF503) and Lamp (RPI Part #CVL505)

Fits: Inspiratory Module

Models: 840

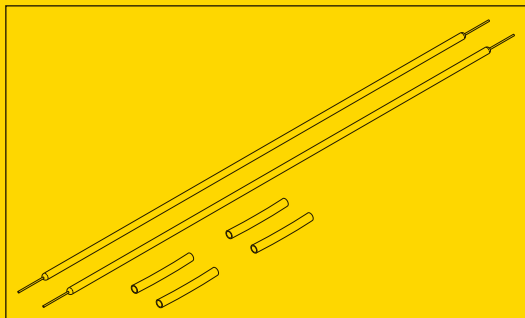
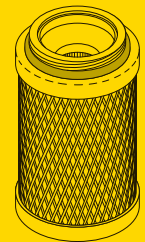

RPI Part #CVL505  
OEM Part # (OEM Part # Not Available)

### LAMP

- 2 per package
- Size: 2.6 mm (.102" dia.) x 214 mm (8.43" lg.) full spectrum CCFL
- Included in: Ventilator PM Kit (with Lamps - 9.4" GUI) (RPI Part #CVK501)
- Also available: Air Inlet Filter (RPI Part #CVF502) and Oxygen Inlet Filter (RPI Part #CVF503)

Fits: 9.4" GUI

Models: 840

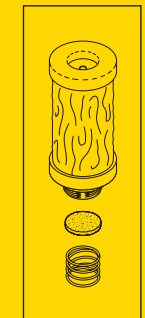

RPI Part #CVF503  
OEM Part #4-072204-00

### OXYGEN INLET FILTER

- 0.3 micron
- Size: .96" dia. x 1.91" lg.
- Included in: Ventilator PM Kit (10.4" GUI) (RPI Part #CVK500) and Ventilator PM Kit (with Lamps - 9.4" GUI) (RPI Part #CVK501)
- Also available: Air Inlet Filter (RPI Part #CVF502) and Lamp (RPI Part #CVL505)

Fits: Inspiratory Module

Models: 840



replacement parts industries, inc.

CALL (800) 221-9723 • FAX (818) 882-7028 • EMAIL [order@riparts.com](mailto:order@riparts.com) • WEBSITE [www.riparts.com](http://www.riparts.com)

The above parts are manufactured by Replacement Parts Industries, Inc. to fit the equipment noted. All product names used in this document are trademarks or registered trademarks of their respective holders. 2008CV SHOW 01/21

# New PM Kits to fit Covidien/Puritan Bennett™ 840 Ventilators!

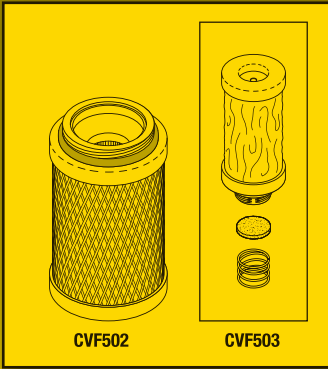

CVF502

CVF503

RPI Part #CVK500  
 OEM Part #4-078179-00  
 VENTILATOR PM KIT (10.4" GUI)

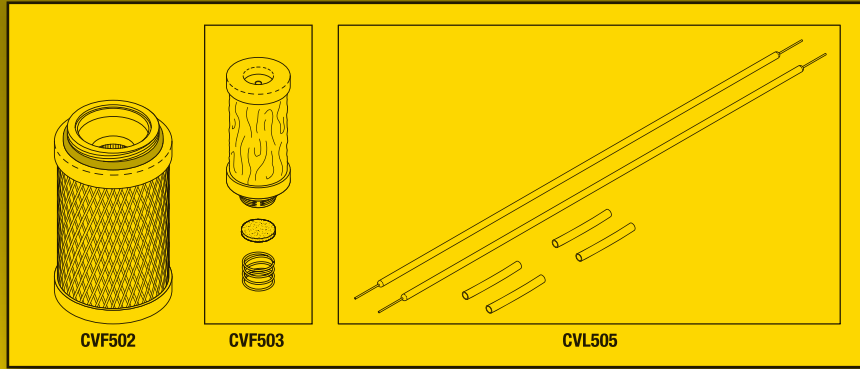

CVF502

CVF503

CVL505

RPI Part #CVK501  
 OEM Part #4-079056-00  
 VENTILATOR PM KIT (WITH LAMPS - 9.4" GUI)

# New Line of Parts to fit Covidien/Puritan Bennett™ 840 Ventilators!

ADDRESS SERVICES REQUESTED

**replacement parts industries, inc.**  
 625 Cochran Street • Simi Valley, California • 93065



PERMIT NO. 2399  
 VAN NUYS, CA  
 U.S. POSTAGE PAID  
 PRESORTED STANDARD

# New Parts to fit Covidien/Puritan Bennett™ 840 Ventilators!

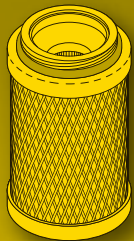

RPI Part #CVF502  
 OEM Part #4-072203-00  
 AIR INLET FILTER

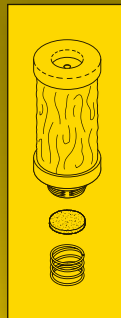

RPI Part #CVF503  
 OEM Part #4-072204-00  
 OXYGEN INLET FILTER

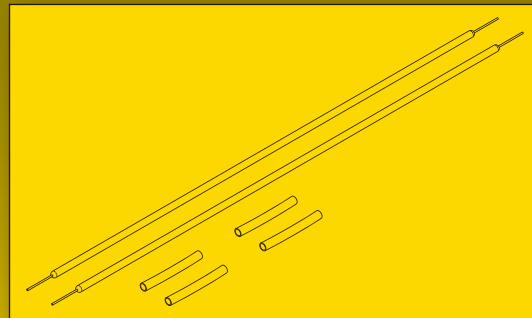

RPI Part #CVL505  
 OEM Part # (OEM Part # Not Available)  
 LAMP





# Pricing Reduced on New Parts to fit Covidien/Puritan Bennett™ 840 Ventilators!

We made a big error in the pricing of our new line of parts to fit Covidien/Puritan Bennett™ 840 Ventilators!

Our pricing should have been lower, *much lower!*

Please accept our apology and note the new lower prices. And for our customers who have already purchased any of these parts, please note that a credit for the difference will be added to your account.

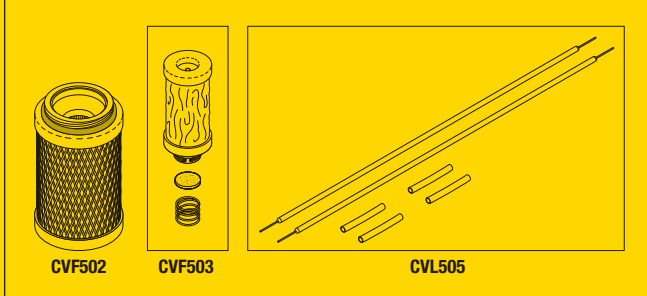

**RPI Part #CVK501**  
**OEM Part #4-079056-00**

**VENTILATOR PM KIT (WITH LAMPS - 9.4" GUI)**

- 10,000 hour Planned Maintenance Kit
- Includes: Air Inlet Filter (RPI Part #CVF502), Oxygen Inlet Filter (RPI Part #CVF503), Lamp (RPI Part #CVL505), and PM Sticker

**Models: 840**

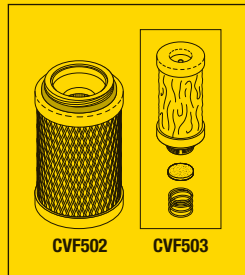

**RPI Part #CVK500**  
**OEM Part #4-078179-00**

**VENTILATOR PM KIT (10.4" GUI)**

- 10,000 hour Planned Maintenance Kit
- Includes: Air Inlet Filter (RPI Part #CVF502), Oxygen Inlet Filter (RPI Part #CVF503), and PM Sticker

**Models: 840**



**RPI Part #CVF502**  
**OEM Part #4-072203-00**

**AIR INLET FILTER**

- 0.3 micron
- Size: 1-3/4" dia. x 2-3/4" lg.
- Included in: Ventilator PM Kit (10.4" GUI) (RPI Part #CVK500) and Ventilator PM Kit (with Lamps - 9.4" GUI) (RPI Part #CVK501)
- Also available: Oxygen Inlet Filter (RPI Part #CVF503) and Lamp (RPI Part #CVL505)

**Fits: Inspiratory Module**  
**Models: 840**



**RPI Part #CVF503**  
**OEM Part #4-072204-00**

**OXYGEN INLET FILTER**

- 0.3 micron
- Size: .96" dia. x 1.91" lg.
- Included in: Ventilator PM Kit (10.4" GUI) (RPI Part #CVK500) and Ventilator PM Kit (with Lamps - 9.4" GUI) (RPI Part #CVK501)
- Also available: Air Inlet Filter (RPI Part #CVF502) and Lamp (RPI Part #CVL505)

**Fits: Inspiratory Module**  
**Models: 840**

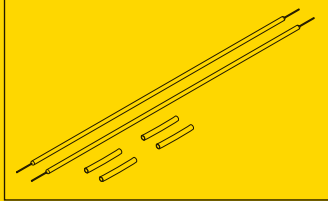

**RPI Part #CVL505**  
**OEM Part # (OEM Part # Not Available)**

**LAMP**

- 2 per package
- Size: 2.6 mm (.102" dia.) x 214 mm (8.43" lg.) full spectrum CCFL
- Included in: Ventilator PM Kit (with Lamps - 9.4" GUI) (RPI Part #CVK501)
- Also available: Air Inlet Filter (RPI Part #CVF502) and Oxygen Inlet Filter (RPI Part #CVF503)

**Fits: 9.4" GUI**  
**Models: 840**



replacement parts industries, inc.

CALL (800) 221-9723 • FAX (818) 882-7028 • EMAIL [order@riparts.com](mailto:order@riparts.com) • WEBSITE [www.rpiparts.com](http://www.rpiparts.com)

The above parts are manufactured by Replacement Parts Industries, Inc. to fit the equipment noted. All product names used in this document are trademarks or registered trademarks of their respective holders. 2008CV SHOW 06/21

COVIDIEN/PURITAN BENNETT

SECTION 5  
 PAGE 700  
 UPDATED 06/21



# Pricing Reduced on New Parts to fit Covidien/Puritan Bennett™ 840 Ventilators!

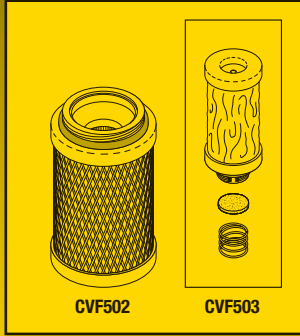

CVF502

CVF503

RPI Part #CVK500  
OEM Part #4-078179-00  
VENTILATOR PM KIT (10.4" GUI)

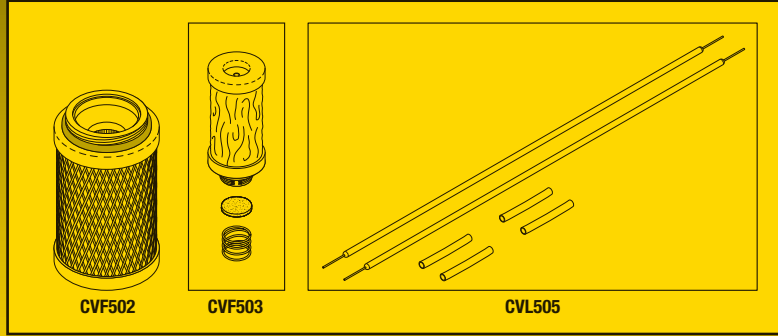

CVF502

CVF503

CVL505

RPI Part #CVK501  
OEM Part #4-079056-00  
VENTILATOR PM KIT (WITH LAMPS - 9.4" GUI)

# Pricing Reduced on New Parts to fit Covidien/Puritan Bennett™ 840 Ventilators!

ADDRESS SERVICES REQUESTED

**replacement parts industries, inc.**  
625 Cochran Street • Simi Valley, California • 93065



PRESENTED STANDARD  
U.S. POSTAGE PAID  
VAN NUYS, CA  
PERMIT NO. 2399



# Pricing Reduced on New Parts to fit Covidien/Puritan Bennett™ 840 Ventilators!

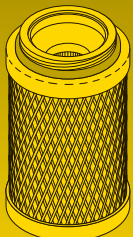

RPI Part #CVF502  
OEM Part #4-072203-00  
AIR INLET FILTER

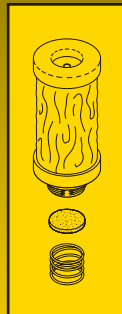

RPI Part #CVF503  
OEM Part #4-072204-00  
OXYGEN INLET FILTER

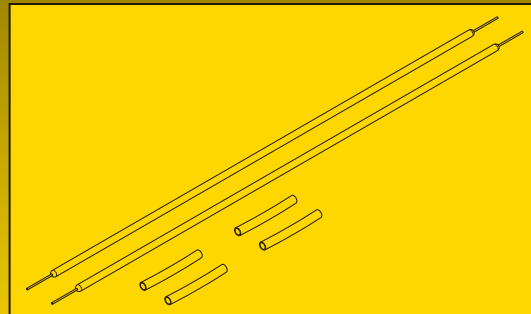

RPI Part #CVL505  
OEM Part # (OEM Part # Not Available)  
LAMP