

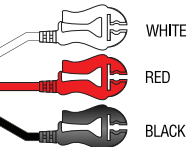







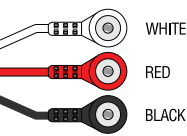

**PATIENT LEADWIRE SETS**

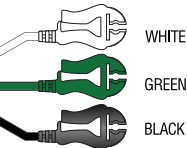
RPI PART #	DESCRIPTION	# OF LEADS	LENGTH	EQUIPMENT END	PATIENT END	NOTES
LKM002	3 LEADWIRE SET - 24" DIN/PINCH	3	~24"	Din/Unshielded .060" Safety Socket 	Pinch 	<b>Also available:</b> • Disposable Leadwire Set (RPI Part #LDM308) & 3 Lead Organizer (RPI Part #LAR004)
LKM005	3 LEADWIRE SET - 24" DIN/SNAP	3	~24"	Din/Unshielded .060" Safety Socket 	Snap 	<b>Also available:</b> • Disposable Leadwire Set (RPI Part #LDM301) & 3 Lead Organizer (RPI Part #LAR004)
LKM008	3 LEADWIRE SET - 24" DIN/PINCH	3	~24"	Din/Unshielded .060" Safety Socket 	Pinch 	<b>Also available:</b> • Disposable Leadwire Set (RPI Part #LDM309) & 3 Lead Organizer (RPI Part #LAR004)
LKM011	3 LEADWIRE SET - 24" DIN/SNAP	3	~24"	Din/Unshielded .060" Safety Socket 	Snap 	• This Leadwire Set replaces RPI Part #HPC003 <b>Also available:</b> • Disposable Leadwire Set (RPI Part #LDM302) & 3 Lead Organizer (RPI Part #LAR004)
LKM014	3 LEADWIRE SET - 40" DUAL/PINCH	3	~40"	Dual/Shielded 	Pinch 	• Includes: 3 Lead Shielded Accessory Kit (RPI Part #LAK006) <b>Also available:</b> • Disposable Leadwire Set (RPI Part #LDM312)
LKM017	3 LEADWIRE SET - 40" DUAL/SNAP	3	~40"	Dual/Shielded 	Snap 	• Includes: 3 Lead Shielded Accessory Kit (RPI Part #LAK006) <b>Also available:</b> • Disposable Leadwire Set (RPI Part #LDM305)
LKM020	3 LEADWIRE SET - 40" DUAL/PINCH	3	~40"	Dual/Shielded 	Pinch 	• Includes: 3 Lead Shielded Accessory Kit (RPI Part #LAK006) <b>Also available:</b> • Disposable Leadwire Set (RPI Part #LDM313)
LKM023	3 LEADWIRE SET - 40" DUAL/SNAP	3	~40"	Dual/Shielded 	Snap 	• Includes: 3 Lead Shielded Accessory Kit (RPI Part #LAK006) <b>Also available:</b> • Disposable Leadwire Set (RPI Part #LDM306)

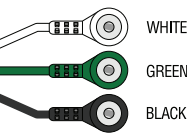
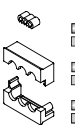
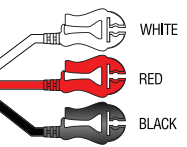
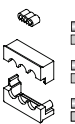
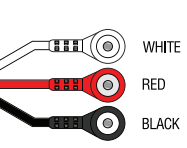

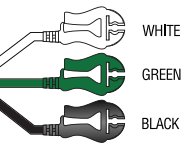
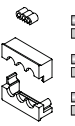
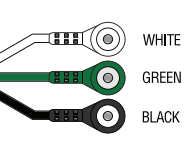

## PATIENT LEADWIRE SETS *(Continued)*

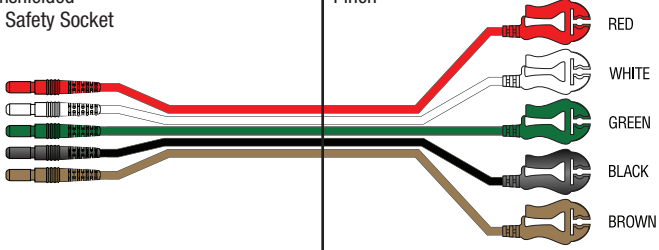
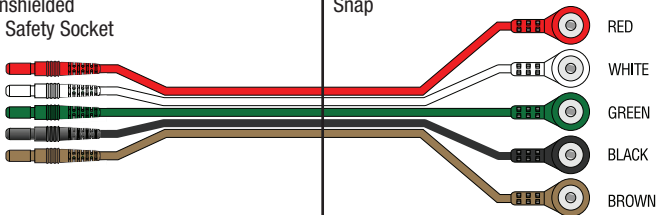
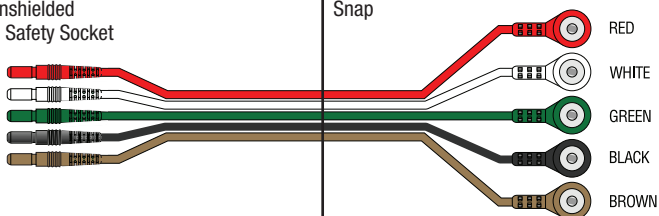
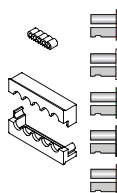
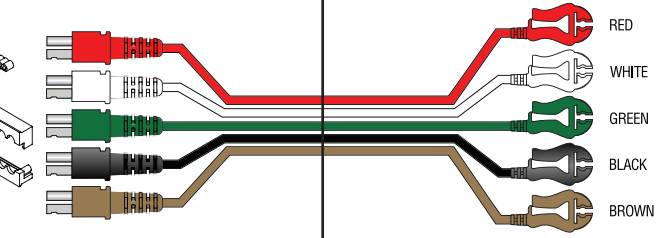
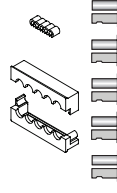
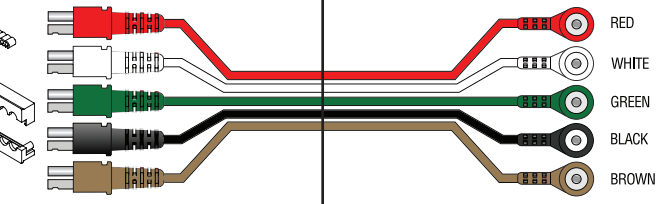
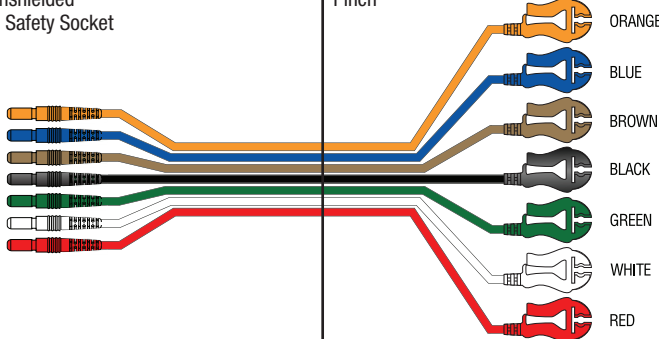
RPI PART #	DESCRIPTION	# OF LEADS	LENGTH	EQUIPMENT END	PATIENT END	NOTES
LKM026	5 LEADWIRE SET - 24" DIN/PINCH	5	~24"	Din/Unshielded .060" Safety Socket	Pinch 	<b>Also available:</b> • Disposable Leadwire Set (RPI Part #LDM310) & 5 Lead Organizer (RPI Part #LAR005)
LKM029	5 LEADWIRE SET - 24" DIN/SNAP	5	~24"	Din/Unshielded .060" Safety Socket	Snap 	<b>Also available:</b> • Disposable Leadwire Set (RPI Part #LDM303) & 5 Lead Organizer (RPI Part #LAR005)
LKM030	5 LEADWIRE SET - 40" DIN/SNAP	5	~40"	Din/Unshielded .060" Safety Socket	Snap 	• This Leadwire Set replaces RPI Part #HPC007 <b>Also available:</b> • 24" Disposable Leadwire Set (RPI Part #LDM303) & 5 Lead Organizer (RPI Part #LAR005)
LKM032	5 LEADWIRE SET - 40" DUAL/PINCH	5	~40"	Dual/Shielded 	Pinch 	• Includes: 5 Lead Shielded Accessory Kit (RPI Part #LAK007) <b>Also available:</b> • Disposable Leadwire Set (RPI Part #LDM314)
LKM035	5 LEADWIRE SET - 40" DUAL/SNAP	5	~40"	Dual/Shielded 	Snap 	• Includes: 5 Lead Shielded Accessory Kit (RPI Part #LAK007) <b>Also available:</b> • Disposable Leadwire Set (RPI Part #LDM307)
LKM038	7 LEADWIRE SET - 24" DIN/PINCH	7	~24"	Din/Unshielded .060" Safety Socket	Pinch 	<b>Also available:</b> • Disposable Leadwire Set (RPI Part #LDM311), 3 Lead Organizer (RPI Part #LAR004), 5 Lead Organizer (RPI Part #LAR005)



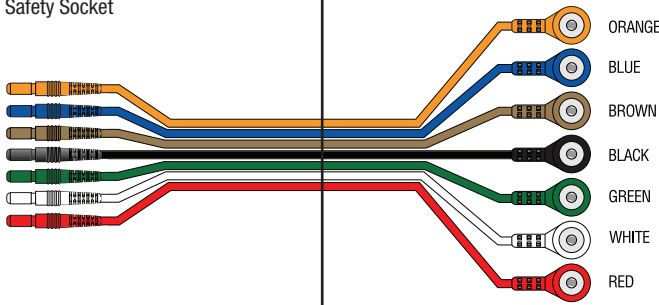
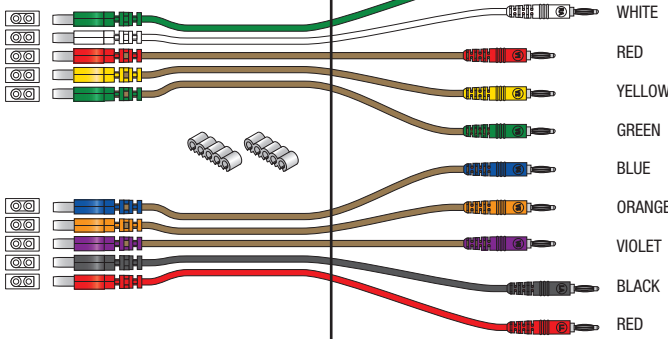
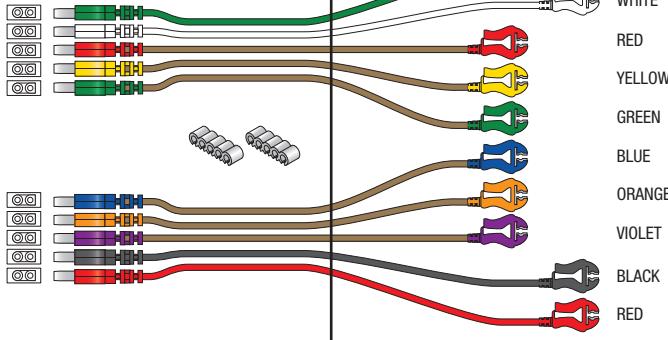
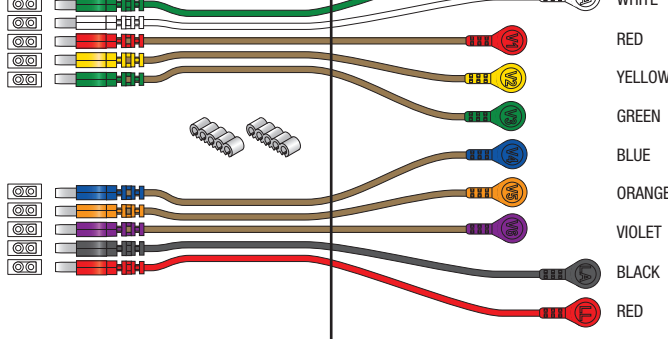

## PATIENT LEADWIRE SETS *(Continued)*

RPI PART #	DESCRIPTION	# OF LEADS	LENGTH	EQUIPMENT END	PATIENT END	NOTES
<b>LKM041</b>	7 LEADWIRE SET - 24" DIN/SNAP	7	~24"	Din/Unshielded .060" Safety Socket	Snap 	<p><b>Also available:</b></p> <ul style="list-style-type: none"> <li>Disposable Leadwire Set (RPI Part #LDM304), 3 Lead Organizer (RPI Part #LAR004), 5 Lead Organizer (RPI Part #LAR005)</li> </ul>
<b>LKM049</b>	10 LEADWIRE SET - CAM 14/BANANA  <b>Fits:</b> CAM 14 Module	10	(6) ~27" (4) ~37"	Dual Shielded; Compatible with GE Multi-Link® 	Banana Plug	<p>• OEM Part #420101-002</p> <p>• Includes: (2) 5 Lead Organizer (RPI Part #LAR005)</p> <p>• Length: ~27": Red (V1), Yellow (V2), Green (V3), Blue (V4), Orange (V5), Violet (V6); and, ~37": Green (RL), White (RA), Black (LA) &amp; Red (LL)</p> <p><b>Also available:</b></p> <ul style="list-style-type: none"> <li>10 Leadwire Sets (RPI Part #'s LKM050 &amp; LKM051)</li> </ul>
<b>LKM050</b>	10 LEADWIRE SET - CAM 14/PINCH  <b>Fits:</b> CAM 14 Module	10	(6) ~27" (4) ~37"	Dual Shielded; Compatible with GE Multi-Link® 	Pinch	<p>• OEM Part #420101-002</p> <p>• Includes: (2) 5 Lead Organizer (RPI Part #LAR005)</p> <p>• Length: ~27": Red (V1), Yellow (V2), Green (V3), Blue (V4), Orange (V5), Violet (V6); and, ~37": Green (RL), White (RA), Black (LA) &amp; Red (LL)</p> <p><b>Also available:</b></p> <ul style="list-style-type: none"> <li>10 Leadwire Sets (RPI Part #'s LKM049 &amp; LKM051)</li> </ul>
<b>LKM051</b>	10 LEADWIRE SET - CAM 14/SNAP  <b>Fits:</b> CAM 14 Module	10	(6) ~27" (4) ~37"	Dual Shielded; Compatible with GE Multi-Link® 	Snap	<p>• OEM Part #420101-002</p> <p>• Includes: (2) 5 Lead Organizer (RPI Part #LAR005)</p> <p>• Length: ~27": Red (V1), Yellow (V2), Green (V3), Blue (V4), Orange (V5), Violet (V6); and, ~37": Green (RL), White (RA), Black (LA) &amp; Red (LL)</p> <p><b>Also available:</b></p> <ul style="list-style-type: none"> <li>10 Leadwire Sets (RPI Part #'s LKM049 &amp; LKM050)</li> </ul>



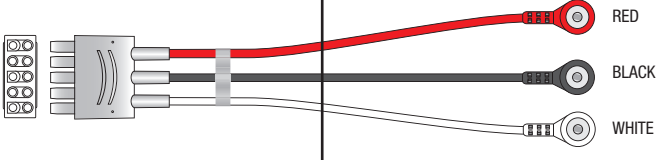
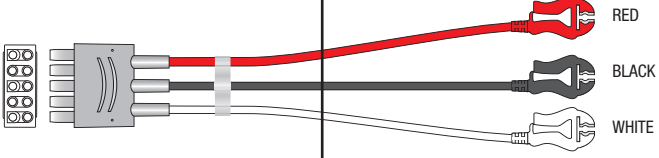
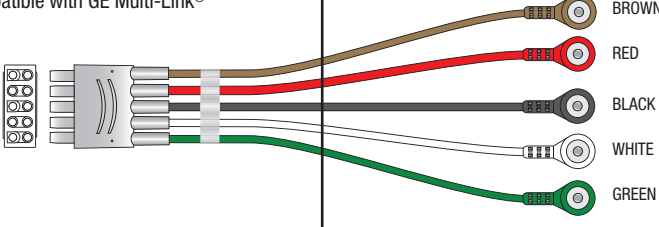
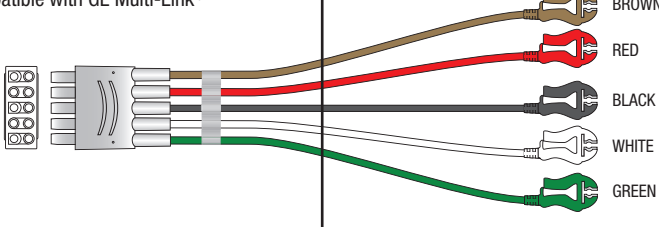
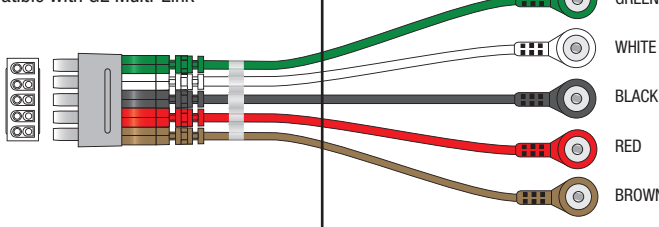
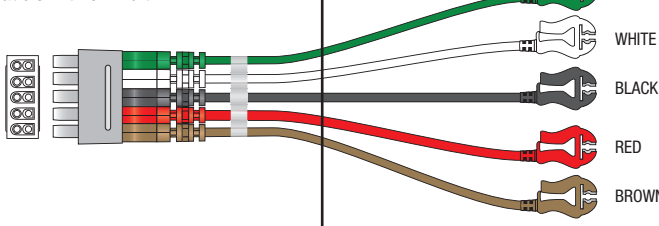

## PATIENT LEADWIRE SETS *(Continued)*

RPI PART #	DESCRIPTION	# OF LEADS	LENGTH	EQUIPMENT END	PATIENT END	NOTES
LKM052	3 LEADWIRE SET - 30" MULTI-LINK/ SNAP  <b>Fits:</b> GE Multi-Link® Cable, Patient Cable - 5 Lead Multi-Link® (RPI Part #KED021) and Patient Cable - 3 Lead Multi-Link® (RPI Part #KCD033)	3 Bonded	~30"	Dual Shielded; Jumper 1 to 5 with 130M Ω Resistor; Compatible with GE Multi-Link®	Snap  	<ul style="list-style-type: none"> <li>OEM Part #411203-001</li> <li>Includes: 3 Lead Organizer (RPI Part #LAR004)</li> <li><b>Also available:</b></li> <li>Bonded Leadwire Sets (RPI Part #'s LKM053, LKM054 &amp; LKM055)</li> <li>Combined Leadwire Sets (RPI Part #'s LKM056 &amp; LKM057)</li> </ul>
LKM053	3 LEADWIRE SET - 30" MULTI-LINK/ PINCH  <b>Fits:</b> GE Multi-Link® Cable, Patient Cable - 5 Lead Multi-Link® (RPI Part #KED021) and Patient Cable - 3 Lead Multi-Link® (RPI Part #KCD033)	3 Bonded	~30"	Dual Shielded; Jumper 1 to 5 with 130M Ω Resistor; Compatible with GE Multi-Link®	Pinch  	<ul style="list-style-type: none"> <li>OEM Part #412682-001</li> <li>Includes: 3 Lead Organizer (RPI Part #LAR004)</li> <li><b>Also available:</b></li> <li>Bonded Leadwire Sets (RPI Part #'s LKM052, LKM054 &amp; LKM055)</li> <li>Combined Leadwire Sets (RPI Part #'s LKM056 &amp; LKM057)</li> </ul>
LKM054	5 LEADWIRE SET - 30" MULTI-LINK/ SNAP  <b>Fits:</b> GE Multi-Link® Cable, Patient Cable - 5 Lead Multi-Link® (RPI Part #KED021)	5 Bonded	~30"	Dual Shielded; Compatible with GE Multi-Link®	Snap  	<ul style="list-style-type: none"> <li>OEM Part #411202-001</li> <li>Includes: 5 Lead Organizer (RPI Part #LAR005)</li> <li><b>Also available:</b></li> <li>Bonded Leadwire Sets (RPI Part #'s LKM052, LKM053 &amp; LKM055)</li> <li>Combined Leadwire Sets (RPI Part #'s LKM056 &amp; LKM057)</li> </ul>
LKM055	5 LEADWIRE SET - 30" MULTI-LINK/ PINCH  <b>Fits:</b> GE Multi-Link® Cable, Patient Cable - 5 Lead Multi-Link® (RPI Part #KED021)	5 Bonded	~30"	Dual Shielded; Compatible with GE Multi-Link®	Pinch  	<ul style="list-style-type: none"> <li>OEM Part #412681-001</li> <li>Includes: 5 Lead Organizer (RPI Part #LAR005)</li> <li><b>Also available:</b></li> <li>Bonded Leadwire Sets (RPI Part #'s LKM052, LKM053 &amp; LKM054)</li> <li>Combined Leadwire Sets (RPI Part #'s LKM056 &amp; LKM057)</li> </ul>
LKM056	5 LEADWIRE SET - 30" MULTI-LINK/ SNAP  <b>Fits:</b> GE Multi-Link® Cable, Patient Cable - 5 Lead Multi-Link® (RPI Part #KED021)	5 with Combiner	~30"	Dual Shielded; Compatible with GE Multi-Link®	Snap  	<ul style="list-style-type: none"> <li>OEM Part #411200-001</li> <li>Includes: 5 Lead Organizer (RPI Part #LAR005) and combiner</li> <li><b>Also available:</b></li> <li>Bonded Leadwire Sets (RPI Part #'s LKM052, LKM053, LKM054 &amp; LKM055)</li> <li>Combined Leadwire Set (RPI Part #LKM057)</li> </ul>
LKM057	5 LEADWIRE SET - 30" MULTI-LINK/ PINCH  <b>Fits:</b> GE Multi-Link® Cable, Patient Cable - 5 Lead Multi-Link® (RPI Part #KED021)	5 with Combiner	~30"	Dual Shielded; Compatible with GE Multi-Link®	Pinch  	<ul style="list-style-type: none"> <li>OEM Part #414556-001</li> <li>Includes: 5 Lead Organizer (RPI Part #LAR005) and combiner</li> <li><b>Also available:</b></li> <li>Bonded Leadwire Sets (RPI Part #'s LKM052, LKM053, LKM054 &amp; LKM055)</li> <li>Combined Leadwire Set (RPI Part #LKM056)</li> </ul>



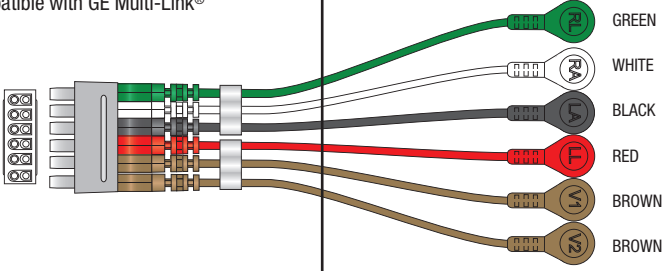
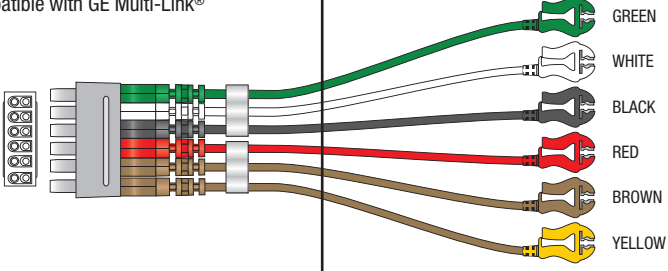

## PATIENT LEADWIRE SETS *(Continued)*

RPI PART #	DESCRIPTION	# OF LEADS	LENGTH	EQUIPMENT END	PATIENT END	NOTES
<b>LKM058</b>	6 LEADWIRE SET - 30" MULTI-LINK/ SNAP	6 with Combiner	~30"	Dual Shielded; Compatible with GE Multi-Link®	Snap  	<ul style="list-style-type: none"> <li>• OEM Part #421930-001</li> <li>• Includes: (2) 3 Lead Organizer (RPI Part #LAR004) and 6 lead combiner</li> <li><b>Also available:</b></li> <li>• Combined Leadwire Set (RPI Part #LKM059)</li> </ul>
<b>LKM059</b>	6 LEADWIRE SET - 30" MULTI-LINK/ PINCH	6 with Combiner	~30"	Dual Shielded; Compatible with GE Multi-Link®	Pinch  	<ul style="list-style-type: none"> <li>• OEM Part #421932-001</li> <li>• Includes: (2) 3 Lead Organizer (RPI Part #LAR004) and 6 lead combiner</li> <li><b>Also available:</b></li> <li>• Combined Leadwire Set (RPI Part #LKM058)</li> </ul>

