

New Parts to fit Midmark® • Ritter® M9 & M11 UltraClave® Sterilizers!

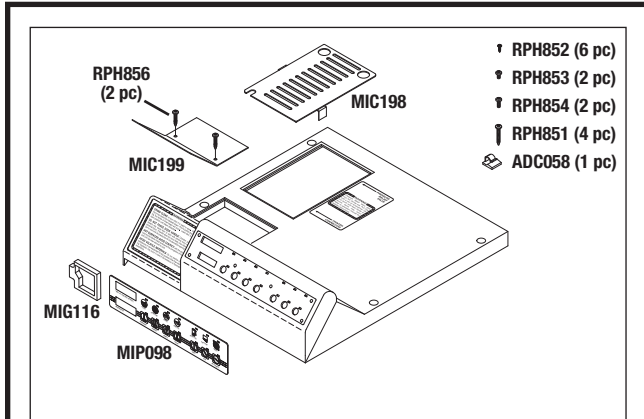

- RPH852 (6 pc)
- RPH853 (2 pc)
- RPH854 (2 pc)
- RPH851 (4 pc)
- ADC058 (1 pc)

RPI Part #MIK196
OEM Part #002-0356-00



TOP COVER KIT

- Includes all parts as shown
- Also available: Adhesive (RTV108) (RPI Part #RPA874), Display PC Board (RPI Part #MIB115) and Speednut (RPI Part #PCN136)

Models: M9-001 thru -019

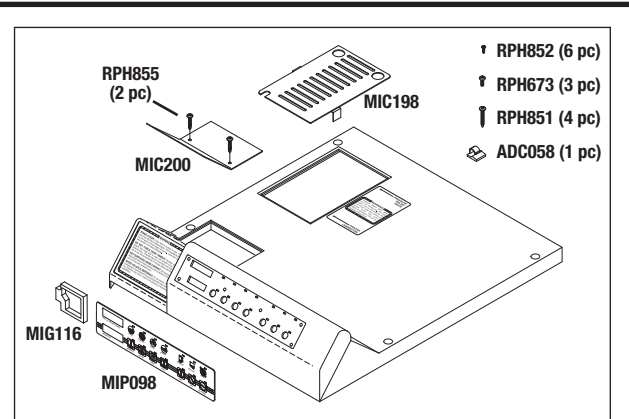

- RPH852 (6 pc)
- RPH673 (3 pc)
- RPH851 (4 pc)
- ADC058 (1 pc)

RPI Part #MIK197
OEM Part #002-0503-00



TOP COVER KIT

- Includes all parts as shown
- Also available: Adhesive (RTV108) (RPI Part #RPA874), Display PC Board (RPI Part #MIB115) and Speednut (RPI Part #PCN136)

Models: M11-001 thru -019

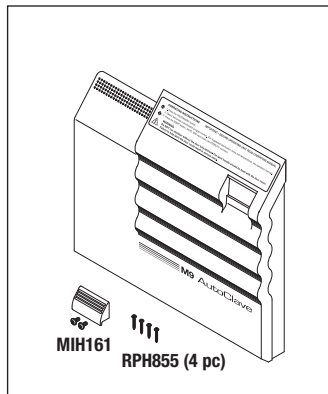

RPI Part #MIK194
OEM Part #002-0364-00/
002-0364-01

DOOR PANEL KIT

- Includes all parts as shown

Fits: Door Frame

Models: M9-001 thru -019

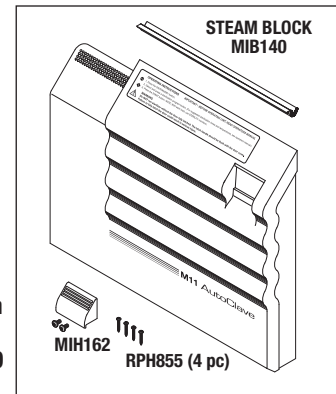

RPI Part #MIK195
OEM Part #002-0506-00/
002-0506-01

DOOR PANEL KIT

- Includes all parts as shown

Fits: Door Frame

Models: M11-001 thru -019

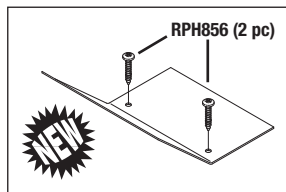

RPI Part #MIC199
OEM Part #050-1775-00

COVER PLATE (PRINTER)

- Includes all parts as shown

Fits: Top Cover

Models: M9-001 thru -019

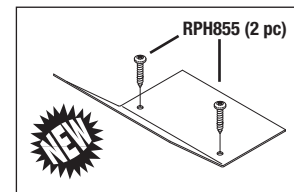

RPI Part #MIC200
OEM Part # (No OEM Part # Available)

COVER PLATE (PRINTER)

- Includes all parts as shown

Fits: **Only** Top Cover Kit (RPI Part #MIK197)

Models: M11-001 thru -019

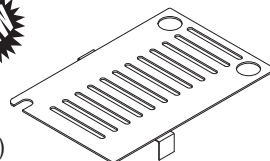

RPI Part #MIC198
OEM Part #030-1117-00/
030-0765-10

TOP INSPECTION COVER

- Included in: Top Cover Kit (RPI Part #'s MIK196 and MIK197)

Fits: Top Cover

Models: M9-001 thru -019 & M11-001 thru -019

RPI Part #MIB140
OEM Part #053-0630-01

STEAM BLOCK

- Included in: Door Panel Kit (RPI Part #MIK195)

- Material: White plastic encapsulated foam

- Size: ~12.0" lg.

Fits: Door Frame (older style units)

Model: M11-001 thru -019

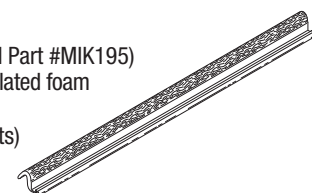



RPI Part #MIK202
OEM Part # (No OEM Part # Available)

FILL/VENT MANIFOLD KIT

- This Kit includes easier to remove hex head mounting bolts instead of Phillips Head screws - it's the RPI Advantage!
- Includes all parts as shown

Fits: Manifold Assembly
Models: M9-001 thru -019 & M11-001 thru -019

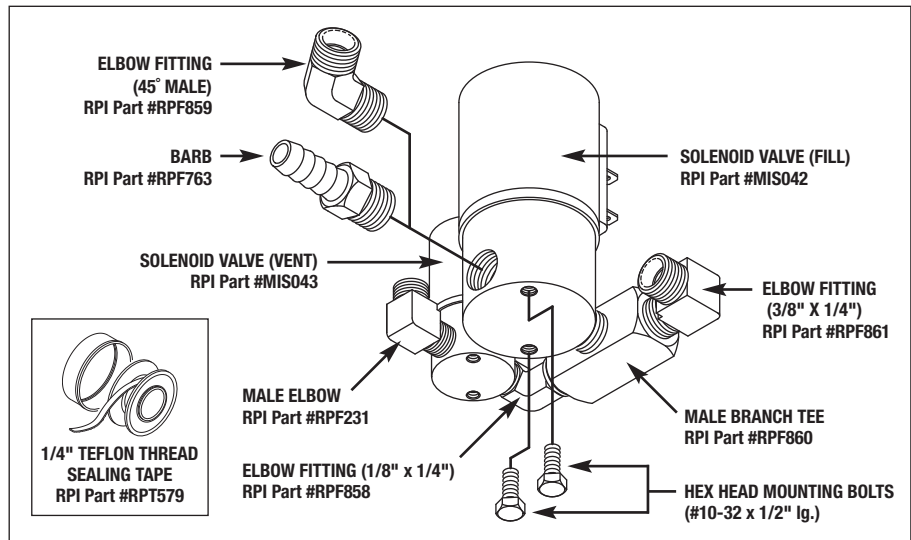

RPI Part #RPF858
OEM Part #014-0218-01

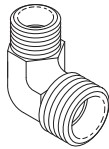

ELBOW FITTING (1/8 X 1/4)

- Material: Brass
- Size: 1/8" MPT x 1/4" MPT
- Included in: Fill/Vent Manifold Kit (RPI Part #MIK202)

Fits: Manifold Assembly
Models: M9-001 thru -019 & M11-001 thru -019



RPI Part #RPF860
OEM Part #014-0224-00

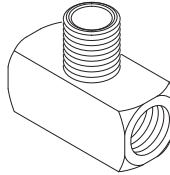

MALE BRANCH TEE

- Material: Brass
- Size: 1/4" MPT x 1/4" FPT x 1/4" FPT
- Included in: Fill/Vent Manifold Kit (RPI Part #MIK202)

Fits: Manifold Assembly
Models: M9-001 thru -019 & M11-001 thru -019

RPI Part #MIS042
OEM Part #002-0365-00

SOLENOID VALVE (FILL)

- Non-manifold mount;
- Mounts on Chassis, AC valve
- 1/4" orifice, 1/4" FPT ports; 120VAC, 60Hz., 10W
- Included in: Fill/Vent Manifold Kit (RPI Part #MIK202)

Fits: Older Style Units and Fill/Vent Manifold
Models: M9-001 thru -019 & M11-001 thru -019

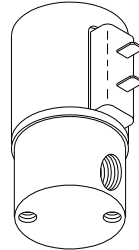

RPI Part #RPF859
OEM Part #014-0201-00

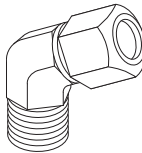

ELBOW FITTING (45° MALE)

- Material: Brass
- Size: 3/8" tubing x 1/4" MPT
- Included in: Fill/Vent Manifold Kit (RPI Part #MIK202)

Fits: Manifold Assembly
Models: M9-001 thru -019 & M11-001 thru -019



RPI Part #RPF861
OEM Part #014-0184-01

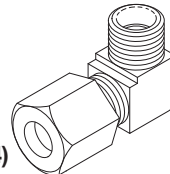

ELBOW FITTING (3/8 X 1/4)

- Material: Brass
- Size: 3/8" tubing x 1/4" MPT
- Included in: Fill/Vent Manifold Kit (RPI Part #MIK202)

Fits: Manifold Assembly
Models: M9-001 thru -019 & M11-001 thru -019

RPI Part #MIS043
OEM Part #002-0366-00

SOLENOID VALVE (VENT)

- Non-manifold mount;
- Mounts on Chassis, AC valve
- 1/8" orifice, 1/8" FPT ports; 120VAC, 60Hz., 7W
- Included in: Fill/Vent Manifold Kit (RPI Part #MIK202)

Fits: Older Style Units and Fill/Vent Manifold
Models: M9-001 thru -019 & M11-001 thru -019

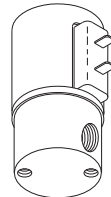

RPI Part #RPF231
OEM Part # (No OEM Part # Available)

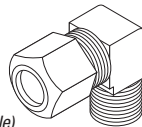

MALE ELBOW - 5/pkg

- Material: Brass
- Size: 1/4" tubing x 1/8" MPT
- Included in: Fill/Vent Manifold Kit (RPI Part #MIK202)

Fits: Fill/Vent Manifold
Models: M9-001 thru -019 & M11-001 thru -019

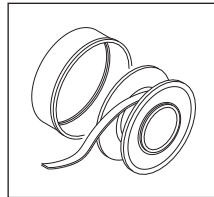

RPI Part #RPT579
OEM Part # (No OEM Part # Available)

1/4" TEFLON THREAD SEALING TAPE

- 5 per package; 1/4" x 260" per unit
- Included in: Fill/Vent Manifold Kit (RPI Part #MIK202)

RPI Part #RPF763
OEM Part #014-0347-00

BARB - 2/pkg

- Size: 3/8" barb to 1/4" MPT; Material: Brass
- Included in: Manifold Block Assembly (RPI Part #MIA096), Fill/Vent Valve Assembly (RPI Part #MIA137), and Fill/Vent Manifold Kit (RPI Part #MIK202)

Fits: Manifold Block Assy. and Fill/Vent Manifold
Models: M9-001 thru -019, M9-020 thru -022, M11-001 thru -019 & M11-020 thru -022

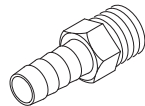

RPI Part #RPT862
OEM Part #053-1033-01/
053-1033-02/053-1033-04/
053-1033-05

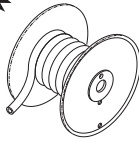

TUBING (3/8 ID NEOPRENE)

- Size: 3/8" ID x 1/2" OD; Color: Black
- Sold by the foot, reel not included

Fits: Water Reservoir to Fill Valve

Models: M9-001 thru -019, M9-020 thru -022, M11-001 thru -019 & M11-020 thru -022

RPI Part #RPT863
OEM Part #053-0613-01/
053-0613-02/053-0613-06/
053-0613-07

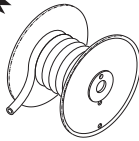

TUBING (3/4 ID NEOPRENE)

- Size: 3/4" ID x 1" OD; Color: Black
- Sold by the foot, reel not included

Fits: Safety Relief Valve & Elbow Barb Fitting

Models: M9-001 thru -019, M9-020 thru -022, M11-001 thru -019 & M11-020 thru -022

RPI Part #RPF684
OEM Part #014-0258-00

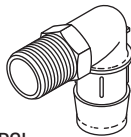

ELBOW BARB FITTING

- 1/2" MPT x 3/4" barb;
- Material: Black Nylon®
- Also available: Safety Valve 35 PSI (RPI Part #PCV052) and Safety Valve 40 PSI (RPI Part #MIV090)

Fits: Safety Valve (35 PSI) and Safety Valve (40 PSI)

Models: M9-001 thru -019, M9-020 thru -022, M11-001 thru -019 & M11-020 thru -022

RPI Part #RPA874
OEM Part # (No OEM Part # Available)

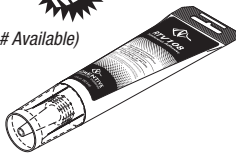

ADHESIVE (RTV108)

- Size: 2.8 fl. oz. tube
- Translucent silicone adhesive/sealant
- Temperature Range: -75°F to +400°F

Models: M9-001 thru -019 & M11-001 thru -019

RPI Part #ADC058
OEM Part # (No OEM Part # Available)



CORD CLIP - 10/pkg

- 3/8" bundle size
- Natural Nylon® with adhesive backing
- Included in: Top Cover Kit (RPI Part #'s MIK196 and MIK197)

Models: M9-001 thru -019 & M11-001 thru -019

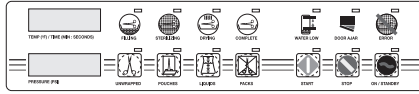

RPI Part #MIP098
OEM Part #061-0272-01

DISPLAY OVERLAY

- Included in: Top Cover Kit (RPI Part #'s MIK196 and MIK197)

Fits: Top Cover (older style units)

Models: M9-001 thru -019 & M11-001 thru -019

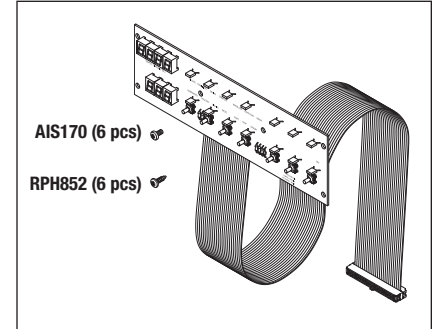

AIS170 (6 pcs)

RPH852 (6 pcs)

RPI Part #MIB115
OEM Part #002-0369-02/015-0646-00 (Cable only)/002-0369-00 (Display PC Board only)

DISPLAY PC BOARD

- Includes: (6) Screws (#6-32 X 3/8") (RPI Part # AIS170) for older style units with threaded inserts and (6) Screws (#6 x 3/8") (RPI Part # RPH852) for newer style units without threaded inserts

Fits: Top Cover

Models: M9-001 thru -019 & M11-001 thru -019

RPI Part #MIG116
OEM Part #053-0454-00

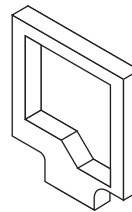

DISPLAY PC BOARD GASKET

- Material: Black Foam Rubber with Adhesive Backing
- Included in: Top Cover Kit (RPI Part #'s MIK196 and MIK197)

Fits: Top Cover (older style units)

Models: M9-001 thru -019 & M11-001 thru -019

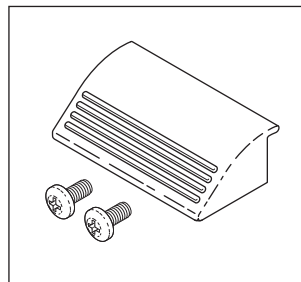

RPI Part #MIH161
OEM Part #053-0912-00

DOOR HANDLE

- Includes: (2) Screw (#10-24 x .375" lg.)
- Included in: Door Panel Kit (RPI Part #MIK194)

Fits: Door (older style units)

Models: M9-001 thru -019

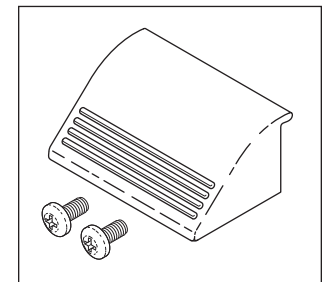

RPI Part #MIH162
OEM Part #053-0909-00

DOOR HANDLE

- Includes: (2) Screw (#10-24 x .375" lg.)
- Included in: Door Panel Kit (RPI Part #MIK195)

Fits: Door (older style units)

Models: M11-001 thru -019

RPI Part #MIK201
OEM Part #042-0106-00/042-0106-01 (Shoulder screw only)/
016-0131-18 (Flanged bushing only)/**045-0000-04** (Washers only)



LATCH LEVER PIVOT KIT

- Includes: Stainless steel shoulder screw, flanged bushing, and (2) washers (for use in machines that do not use the flanged bushing)

Fits: Door Latch Mounting Bracket

Models: M9-001 thru -019, M9-020 thru -022, M11-001 thru -019 & M11-020 thru -022

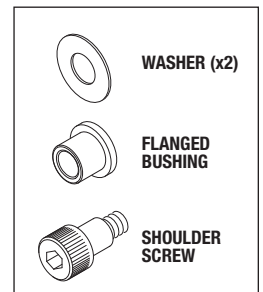

ADDRESS SERVICES REQUESTED

**New Parts to fit
Midmark® • Ritter®
M9 & M11 UltraClave®
Sterilizers!**

RPI Part #RPH851
OEM Part #040-0010-88
SCREW (#10 x 1-1/4) - 12/pkg
• Included in: Top Cover Kit (RPI Part #MIK196 & MIK197)
Fits: Top Covers to Side Panels
Models: M9-001 thru -019 & M11-001 thru -019

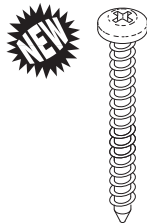

RPI Part #RPH854
OEM Part #040-0010-95
SCREW (#10 x 5/8) - 12/pkg
• Included in: Top Cover Kit (RPI Part #MIK196)
Fits: Steam Block to Top Cover
Models: M9-001 thru -019



RPI Part #RPH673
OEM Part #040-0010-125
SCREW (#10 x 1/2) - 12/pkg
• Included in: Top Cover Kit (RPI Part #MIK197)
Fits: Upper and Lower Rear Panel to Top Cover
Models: M11-001 thru -019



RPI Part #RPH852
OEM Part #040-0006-04
SCREW (#6 x 3/8) - 12/pkg
• Included in: Top Cover Kit (RPI Part #'s MIK196 and MIK197) and Display PC Board (RPI Part #MIB115)
Fits: Display PCB to Top Cover
Models: M9-001 thru -019 & M11-001 thru -019



RPI Part #RPH855
OEM Part #040-0008-50
SCREW (#8 x 7/8) - 12/pkg
• Included in: Cover Plate (Printer) (RPI Part #MIC200) and Door Panel Kit (RPI Part #MIK194)
Fits: Door Panel (M9 & M11) and Printer Cover Plate (M11)
Models: M9-001 thru -019 & M11-001 thru -019



RPI Part #PCN136
OEM Part # (No OEM Part # Available)
SPEEDNUT - 10/pkg
• "U" type #10-24 thread and #10 Type A thread
• Use to mount top cover to rear panel and side panels
Models: M9-001 thru -019 & M11-001 thru -019



RPI Part #RPH853
OEM Part #040-0010-18
SCREW (#10 x 3/8) - 12/pkg
• Included in: Top Cover Kit (RPI Part #MIK196)
Fits: Upper and Lower Rear Panel to Top Cover
Models: M9-001 thru -019



RPI Part #RPH856
OEM Part #040-0008-37
SCREW (#8 x 5/8) - 12/pkg
• Included in: Cover Plate (Printer) (RPI Part #MIC199)
Fits: Printer Cover Plate
Models: M9-001 thru -019



**Don't forget ... Visit our website
www.rpiparts.com
for even more great parts to fit
Midmark®•Ritter® M9 & M11
UltraClave® Sterilizers!**